

Kanlux

Katalog
Catalogue
2019 | 2020

more than
light.





Nam możesz zaufać

You can
trust us

**Kanlux nie jest zwykłą firmą, my rozumiemy
Twoje potrzeby. Dzielimy się pasją, a naszą
inspiracją jesteś Ty. Nasz cel i misja to
kreowanie światła, które rozświetli
Twój dzień i noc.**

Kanlux is not an ordinary company
- we understand your needs.

We share our passion and you are
our inspiration. Our purpose and mission
is to create light that will illuminate
your day and night.

Kanlux 







16
31

OPRAWY Z FABRYKI KANLUX

KANLUX FACTORY FIXTURES

32
107

ŹRÓDŁA ŚWIATŁA

LIGHT SOURCES

108
219

OPRAWY DOMOWE I DEKORACYJNE

DOMESTIC AND DECORATIVE FIXTURES

220
315

OPRAWY TECHNICZNE I ARCHITEKTONICZNE

TECHNICAL AND ARCHITECTURAL FIXTURES

316
364

OSPRZĘT ELEKTROINSTALACYJNY

ELECTRICAL INSTALLATION EQUIPMENT

OPRAWY Z FABRYKI KANLUX KANLUX FACTORY FIXTURES



Kanlux Fabryka ALIN LED
◀ 18 - 19 ▶



Kanlux Fabryka ALIN LED LINE
◀ 20 - 21 ▶



Kanlux Fabryka ALIN 4LED
◀ 22 - 23 ▶



Kanlux Fabryka OFIS LED
◀ 24 - 25 ▶



Kanlux Fabryka OFIS S LED
◀ 26 - 27 ▶



Kanlux Fabryka FUTURIO LED
◀ 28 - 29 ▶

Kanlux
FACTORY

ŹRÓDŁA ŚWIATŁA







LIGHT SOURCES

						
Kanlux IQ-LED A60 ◀ 34 ▶	Kanlux IQ-LED A67 ◀ 35 ▶	Kanlux IQ-LEDDIM A60 ◀ 36 ▶	Kanlux XLED A60 ◀ 37 ▶	Kanlux XLED A60M ◀ 38 ▶	Kanlux XLED STEP DIM ◀ 39 ▶	Kanlux XLED CCT ◀ 39 ▶
						
Kanlux RAPID LED E27 ◀ 40 ▶	Kanlux RAPID LED B22 ◀ 41 ▶	Kanlux EBRI LED ◀ 42 ▶	Kanlux XLED ST64 ◀ 43 ▶	Kanlux XLED G125 ◀ 43 ▶	Kanlux LUNI LED ◀ 44 ▶	Kanlux IQ-LED C37 ◀ 45 ▶
						
Kanlux XLED C35 ◀ 46 ▶	Kanlux XLED C35M ◀ 47 ▶	Kanlux DUN LED ◀ 48 ▶	Kanlux DUN HI LED ◀ 49 ▶	Kanlux IDO LED ◀ 50 ▶	Kanlux IQ-LED G45 ◀ 51 ▶	Kanlux XLED G45 ◀ 52 ▶
						
Kanlux XLED G45M ◀ 53 ▶	Kanlux BILO LED ◀ 54 ▶	Kanlux BILO HI LED ◀ 55 ▶	Kanlux IQ-LED GU10 ◀ 56 ▶	Kanlux IQ-LEDDIM GU10 ◀ 57 ▶	Kanlux REMI LED ◀ 57 ▶	Kanlux FULLED ◀ 58 ▶
						
Kanlux TEZI LED ◀ 59 ▶	Kanlux TOMI LED ◀ 60 ▶	Kanlux PRO GU10 LED ◀ 61 ▶	Kanlux PRODIM ◀ 62 ▶	Kanlux TEDI MAXX LED ◀ 63 ▶	Kanlux LED15 C ◀ 63 ▶	Kanlux TOMI LED ◀ 64 ▶
						
Kanlux SIGO LED ◀ 65 ▶	Kanlux GIO LED G9 ◀ 66 ▶	Kanlux G9 GLASS LED ◀ 66 ▶	Kanlux ZUBI LED ◀ 67 ▶	Kanlux GIO LED G4 ◀ 68 ▶	Kanlux TANO G4 SMD ◀ 68 ▶	Kanlux LED12 SMD ◀ 69 ▶
						
Kanlux AR-111 LED ◀ 70 ▶	Kanlux ES-111 LED ◀ 71 ▶	Kanlux T8 LED GLASSv2 ◀ 73 ▶	Kanlux T8 LED GLASSv3 ◀ 74 ▶	Kanlux T8 LED GLASSv3T ◀ 75 ▶	Kanlux ESG LED ◀ 76 ▶	Kanlux MODv2 LED ◀ 77 ▶

ŹRÓDŁA ŚWIATŁA LIGHT SOURCES

						
Kanlux NIFO LED ◀ 78 ▶	Kanlux RANGO LED ◀ 79 ▶	Kanlux LEDS-B ◀ 80 ▶	Kanlux LEDS-P ◀ 81 ▶	Kanlux LEDS-B RGB ◀ 82 ▶	Kanlux LEDS SET ◀ 83 ▶	Kanlux CONTROLLER ◀ 84 ▶
						
Kanlux PROFILO A ◀ 85 ▶	Kanlux PROFILO B ◀ 86 ▶	Kanlux PROFILO C ◀ 87 ▶	Kanlux PROFILO D ◀ 88 ▶	Kanlux PROFILO E ◀ 89 ▶	Kanlux PROFILO F ◀ 90 ▶	Kanlux PROFILO G ◀ 91 ▶
						
Kanlux PROFILO H ◀ 92 ▶	Kanlux PROFILO I ◀ 93 ▶	Kanlux PROFILO J ◀ 94 ▶	Kanlux PROFILO K ◀ 95 ▶	Kanlux GIVRO LED ◀ 96 ▶	Kanlux GLH ◀ 97 ▶	Kanlux CDH ◀ 98 ▶
						
Kanlux MGH ◀ 98 ▶	Kanlux G9 STAR ◀ 99 ▶	Kanlux JC ◀ 100 ▶	Kanlux J ◀ 101 ▶	Kanlux J STAR ◀ 101 ▶	Kanlux T2U ◀ 102 ▶	Kanlux T1U ◀ 102 ▶
						
Kanlux DD ◀ 103 ▶	Kanlux T5 ◀ 104 ▶	Kanlux T8 ◀ 105 ▶	Kanlux MHE ◀ 106 ▶			

OPRAWY DOMOWE I DEKORACYJNE DOMESTIC AND DECORATIVE FIXTURES

						
Kanlux ETISSA ◀ 110 ▶	Kanlux OGIVA ◀ 110 ▶	Kanlux GRAVME ◀ 111 ▶	Kanlux ALGO P ◀ 112 ▶	Kanlux ROLSA ◀ 113 ▶	Kanlux CORDES ◀ 113 ▶	Kanlux CYDEA P ◀ 114 ▶

OPRAWY DOMOWE I DEKORACYJNE DOMESTIC AND DECORATIVE FIXTURES



Kanlux TOKIA
◀ 114 ▶



Kanlux LUNATI
◀ 115 ▶



Kanlux SANI IP44
◀ 115 ▶



Kanlux BORD
◀ 116-117 ▶



Kanlux GORD
◀ 118 ▶



Kanlux DUCE
◀ 119 ▶



Kanlux ALGO C
◀ 120 ▶



Kanlux RITI
◀ 121 ▶



Kanlux TOLEO
◀ 122-123 ▶



Kanlux STOBI
◀ 124-125 ▶



Kanlux TORIM
◀ 126 ▶



Kanlux MERSA
◀ 127 ▶



Kanlux JASMIN
◀ 128 ▶



Kanlux TIVA
◀ 129 ▶



Kanlux ARDEA
◀ 130 ▶



Kanlux PLAFMIN
◀ 130 ▶



Kanlux VERI LED
◀ 131 ▶



Kanlux MILENO
◀ 132-133 ▶



Kanlux LAURIN
◀ 134-135 ▶



Kanlux LARITO
◀ 136-137 ▶



Kanlux ENALI
◀ 138-139 ▶



Kanlux MOLI
◀ 140 ▶



Kanlux SONDA
◀ 141 ▶



Kanlux EVELI
◀ 142 ▶



Kanlux GLASO
◀ 143 ▶



Kanlux RANVI
◀ 144 ▶



Kanlux SILMA
◀ 145 ▶



Kanlux TUME
◀ 146 ▶



Kanlux CHIRO GU10
◀ 147 ▶



Kanlux MINI BORD
◀ 148 ▶



Kanlux MINI GORD
◀ 148 ▶



Kanlux GOVIK
◀ 149 ▶



Kanlux SIMEN DSO
◀ 150 ▶



Kanlux SIMEN DSL
◀ 151 ▶



Kanlux LUNIO
◀ 152 ▶



Kanlux IMINES
◀ 152 ▶



Kanlux BONIS
◀ 153 ▶



Kanlux ELNIS S
◀ 154 ▶



Kanlux ELNIS L
◀ 155 ▶



Kanlux SPAG
◀ 156 ▶



Kanlux DALLA
◀ 157 ▶



Kanlux IMOEO
◀ 157 ▶



Kanlux SEIDY
◀ 158-159 ▶



Kanlux MORTA AR-ES
◀ 160 ▶



Kanlux MORTA DS
◀ 161 ▶



Kanlux MORTA DT
◀ 162 ▶



Kanlux MORTA B
◀ 163 ▶



Kanlux MORTA OCT
◀ 164 ▶



Kanlux APRILA
◀ 164 ▶

OPRAWY DOMOWE I DEKORACYJNE DOMESTIC AND DECORATIVE FIXTURES



Kanlux SOREN
◀ 165 ▶



Kanlux IVRI
◀ 166 ▶



Kanlux CEMIN
◀ 166 ▶

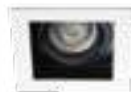

Kanlux ARET
◀ 167 ▶



Kanlux MERIL
◀ 168 ▶



Kanlux ALREN R
◀ 168 ▶



Kanlux ALREN
◀ 169 ▶



Kanlux COLIE
◀ 170 ▶



Kanlux NESTA
◀ 171 ▶



Kanlux EVIT
◀ 172 ▶



Kanlux GWEN
◀ 172 ▶



Kanlux VIDI
◀ 173 ▶



Kanlux NAVI
◀ 174 ▶



Kanlux LUTO
◀ 175 ▶



Kanlux RADAN
◀ 176 ▶



Kanlux TESON
◀ 177 ▶



Kanlux TABO
◀ 178 ▶



Kanlux AKRA
◀ 178 ▶



Kanlux CEL
◀ 179 ▶



Kanlux QULES
◀ 180 ▶



Kanlux MARIN
◀ 181 ▶



Kanlux ARGUS
◀ 182-183 ▶



Kanlux ALOR
◀ 184 ▶



Kanlux DELE
◀ 185 ▶



Kanlux DANERA
◀ 185 ▶



Kanlux ULKE
◀ 186 ▶



Kanlux BASK
◀ 187 ▶



Kanlux HORN
◀ 188 ▶



Kanlux CANTA
◀ 189 ▶



Kanlux ELLI
◀ 189 ▶



Kanlux DINO
◀ 190 ▶



Kanlux NOMA
◀ 190 ▶



Kanlux RODOS
◀ 191 ▶



Kanlux URTICA
◀ 191 ▶



Kanlux ELSE
◀ 192 ▶



Kanlux IMBER
◀ 192 ▶



Kanlux OYO
◀ 193 ▶



Kanlux HAXA
◀ 193 ▶



Kanlux ASIL
◀ 194 ▶



Kanlux KASSI
◀ 195 ▶



Kanlux ASTEN
◀ 196 ▶



Kanlux PESSA
◀ 197 ▶



Kanlux ROLSO
◀ 197 ▶



Kanlux APUS
◀ 198 ▶



Kanlux TERRA
◀ 199 ▶



Kanlux SABIK
◀ 200 ▶



Kanlux SOLA
◀ 201 ▶



Kanlux LIRIA
◀ 201 ▶



Kanlux LINAR
◀ 202 ▶

OPRAWY DOMOWE I DEKORACYJNE DOMESTIC AND DECORATIVE FIXTURES

						
Kanlux SALUT ◀ 203 ▶	Kanlux PLATEN ◀ 203 ▶	Kanlux MERA LED ◀ 204 ▶	Kanlux MERA TL ◀ 205 ▶	Kanlux LINUS LED ◀ 206 ▶	Kanlux GLORIA ◀ 206 ▶	Kanlux PAX LED ◀ 207 ▶
						
Kanlux ZEPO ◀ 207 ▶	Kanlux GAVI ◀ 208 ▶	Kanlux GAVI LED ◀ 209 ▶	Kanlux PIRMO ◀ 209 ▶	Kanlux RUBINAS ◀ 210 ▶	Kanlux ZAFIRAS ◀ 210 ▶	Kanlux DB ◀ 211 ▶
						
Kanlux DRIFT LED ◀ 211 ▶	Kanlux FOLLO LED ◀ 212 ▶	Kanlux FRANCO ◀ 212 ▶	Kanlux DOSAN ◀ 213 ▶	Kanlux ISTI LED ◀ 213 ▶	Kanlux SARI ◀ 214 ▶	Kanlux AWAN ◀ 215 ▶
						
Kanlux HERON LED ◀ 215 ▶	Kanlux PIXA ◀ 216 ▶	Kanlux SUZI ◀ 217 ▶	Kanlux ZARA ◀ 218 ▶	Kanlux CYDEA D ◀ 219 ▶	Kanlux CYDEA F ◀ 219 ▶	

OPRAWY TECHNICZNE I ARCHITEKTONICZNE TECHNICAL AND ARCHITECTURAL FIXTURES

						
Kanlux BRAVO P / PU ◀ 222-223 ▶	Kanlux BRAVO S / SU ◀ 224-225 ▶	Kanlux BLINGO ◀ 226 ▶	Kanlux TOWE LED ◀ 227 ▶	Kanlux NOTUS 4LED / Kanlux NOTUS ◀ 227-228 ▶	Kanlux NOTUS PREMIUM ◀ 229 ▶	Kanlux REGIS ◀ 230 ▶
						
Kanlux REGIS 4LED ◀ 231 ▶	Kanlux AVAR LED ◀ 232 ▶	Kanlux KRALA LED ◀ 233 ▶	Kanlux MAH LED N ◀ 234 ▶	Kanlux MAH PLUS 4LED ◀ 235 ▶	Kanlux MAH PLUS ◀ 236-237 ▶	Kanlux ANDER LED ◀ 237 ▶

OPRAWY TECHNICZNE I ARCHITEKTONICZNE

TECHNICAL AND ARCHITECTURAL FIXTURES

						
Kanlux TP SLIM LED ◀ 238 ▶	Kanlux NOME N ◀ 239 ▶	Kanlux LINER LED ◀ 239 ▶	Kanlux ALDO 4LED ◀ 240-241 ▶	Kanlux MEBA 4LED ◀ 242 ▶	Kanlux DABA LED ECO ◀ 243 ▶	Kanlux DABA N LED SMD ◀ 243 ▶
						
Kanlux VARSO LED ◀ 244-245 ▶	Kanlux ORTE LED ◀ 246 ▶	Kanlux FOGLER LED ◀ 247 ▶	Kanlux SANZO LED ◀ 247 ▶	Kanlux BIGGE LED ◀ 248 ▶	Kanlux TYBIA LED ◀ 249 ▶	Kanlux PORTOS LED ◀ 249 ▶
						
Kanlux FOGLER DL ◀ 250 ▶	Kanlux JURBA DL ◀ 250 ▶	Kanlux KIRA DL ◀ 251 ▶	Kanlux MARC DL ◀ 251 ▶	Kanlux PIREN DL ◀ 252 ▶	Kanlux TYBIA ◀ 253 ▶	Kanlux INES ◀ 253 ▶
						
Kanlux MILE ◀ 254 ▶	Kanlux MILO ◀ 254 ▶	Kanlux HERMI ◀ 255 ▶	Kanlux TURK ◀ 256 ▶	Kanlux SHARK N ◀ 256 ▶	Kanlux SANGA DL ◀ 257 ▶	Kanlux TUNA ◀ 257 ▶
						
Kanlux MATEO ◀ 258 ▶	Kanlux ARTO ◀ 259 ▶	Kanlux OZON ◀ 260 ▶	Kanlux RALF ◀ 260 ▶	Kanlux TIBERI ◀ 261 ▶	Kanlux IVIAN ◀ 261 ▶	Kanlux LITEN ◀ 262 ▶
						
Kanlux ARME LED ◀ 262 ▶	Kanlux AREL LED ◀ 263 ▶	Kanlux ROUND A V2LED ◀ 264 ▶	Kanlux KATRO V2LED ◀ 265 ▶	Kanlux NIKOR ◀ 266 ▶	Kanlux OMERIS ◀ 266 ▶	Kanlux CARSA V2LED ◀ 267 ▶
						
Kanlux KANTI V2LED ◀ 267 ▶	Kanlux DORTO LED ◀ 268 ▶	Kanlux TRAKO LED ◀ 268 ▶	Kanlux TEAR ◀ 269 ▶	Kanlux FL MASTER LED ◀ 270 ▶	Kanlux FLM LED ◀ 271 ▶	Kanlux ANTRA LED ◀ 272-273 ▶

OPRAWY TECHNICZNE I ARCHITEKTONICZNE TECHNICAL AND ARCHITECTURAL FIXTURES



Kanlux ANTOS LED
◀ 274 ▶



Kanlux STATO LED
◀ 275 ▶



Kanlux ELIOT
◀ 275 ▶



Kanlux AVIA MTH
◀ 276 ▶



Kanlux ADAMO MTH
◀ 277 ▶



Kanlux HB MASTER LED
◀ 278-279 ▶



Kanlux HB PRO LED
◀ 280 ▶



Kanlux EURO MTH
◀ 281 ▶



Kanlux STREET LED
◀ 282 ▶



Kanlux LART EL
◀ 284 ▶



Kanlux BART EL
◀ 285 ▶



Kanlux BART DL
◀ 286 ▶



Kanlux MAGRA EL
◀ 286 ▶



Kanlux ZEWA EL
◀ 287 ▶



Kanlux ELNER LED
◀ 288 ▶



Kanlux REKA LED
◀ 289 ▶



Kanlux BISO LED
◀ 290 ▶



Kanlux FORRO LED
◀ 290 ▶



Kanlux GARTO LED
◀ 291 ▶



Kanlux CROTO LED
◀ 291 ▶



Kanlux DORA LED
◀ 292 ▶



Kanlux LICA LED
◀ 292 ▶



Kanlux LINDA LED
◀ 293 ▶



Kanlux ONSTAR LED
◀ 293 ▶



Kanlux TAXI SMD
◀ 294 ▶



Kanlux TURRO LED
◀ 295 ▶



Kanlux XARD DL
◀ 295 ▶



Kanlux BERG DL
◀ 296 ▶



Kanlux GORDO LED14
◀ 296 ▶



Kanlux MORO DL
◀ 297 ▶



Kanlux ROGER DL
◀ 297 ▶



Kanlux INVO OP
◀ 299 ▶



Kanlux INVO TR
◀ 300 ▶



Kanlux SEVIA LED
◀ 301 ▶



Kanlux AGARA LED
◀ 302 ▶



Kanlux GORI
◀ 303 ▶



Kanlux NOVIA
◀ 304 ▶



Kanlux DARSA EL
◀ 305 ▶



Kanlux SORTA
◀ 306 ▶



Kanlux VADRA
◀ 307 ▶



Kanlux RILA
◀ 308 ▶



Kanlux LUCEA
◀ 309 ▶



Kanlux STONO
◀ 310 ▶



Kanlux IDAVA
◀ 312 ▶



Kanlux AKVEN LED
◀ 313 ▶



Kanlux GRIBLO LED
◀ 313 ▶



Kanlux SOBI
◀ 314 ▶



Kanlux SOPER
◀ 314 ▶



Kanlux SOALE
◀ 315 ▶

OSPRZĘT ELEKTROINSTALACYJNY ELECTRICAL INSTALLATION EQUIPMENT



Kanlux ALER MINI
◀ 318 ▶



Kanlux ALER JQ
◀ 318 ▶



Kanlux ZONA JQ
◀ 319 ▶



Kanlux MARID JQ
◀ 319 ▶



Kanlux MERGE JQ
◀ 320 ▶



Kanlux ROLF JQ
◀ 320 ▶



Kanlux ROLF JQ
◀ 321 ▶



Kanlux SLICK JQ
◀ 321 ▶



Kanlux MERGE JQ
◀ 322 ▶



Kanlux ROLF JQ
◀ 322 ▶



Kanlux MERGE
◀ 323 ▶



Kanlux MERGE
◀ 323 ▶



Kanlux SENTO
◀ 324 ▶



Kanlux SENZO
◀ 324 ▶



Kanlux ZONA
◀ 326 ▶



Kanlux AZ-10A
◀ 326 ▶



Kanlux CYBER
◀ 327 ▶



Kanlux STER TS-MF
◀ 327 ▶



Kanlux ADI
◀ 328 ▶



Kanlux CIRCO
◀ 328 ▶



Kanlux DRIFT
◀ 329 ▶



Kanlux DRIVE
◀ 329 ▶



Kanlux POWELED
◀ 330 ▶



Kanlux RICO
◀ 330 ▶



Kanlux SET
◀ 331 ▶



Kanlux STEL
◀ 331 ▶



Kanlux TRETO
◀ 332 ▶



Kanlux DimGO
◀ 332 ▶



Kanlux BL
◀ 333 ▶



Kanlux BS
◀ 334 ▶



Kanlux WIR ZL
◀ 335 ▶



Kanlux TWISTER
◀ 336 ▶



Kanlux CYKLON
◀ 337 ▶



Kanlux LUNGA
◀ 338 ▶



Kanlux LUNGA S
◀ 339 ▶



Kanlux NOKA W
◀ 340 ▶



Kanlux NOKA O
◀ 341 ▶



Kanlux MANGO
◀ 342 ▶



Kanlux DIVISO
◀ 343 ▶



Kanlux GP-2
◀ 343 ▶



Kanlux GRIP
◀ 344 ▶



Kanlux PIN W/US
◀ 344 ▶



Kanlux STAN GP
◀ 345 ▶



Kanlux W-1 NANO
◀ 345 ▶



Kanlux ZARK
◀ 346 ▶



Kanlux APO
◀ 346 ▶



Kanlux BR-GZ10
◀ 347 ▶



Kanlux HLDR-E14
◀ 347 ▶



Kanlux HLDR-E14
◀ 348 ▶

OSPRZĘT ELEKTROINSTALACYJNY ELECTRICAL INSTALLATION EQUIPMENT



Kanlux HLDR-E27
◀ 348 ▶



Kanlux HLDR-E27
◀ 349 ▶



Kanlux HLDR-E27
◀ 349 ▶



Kanlux HLDR-G9
◀ 350 ▶



Kanlux HLDR-GX5.3
◀ 350 ▶



Kanlux HLDR-GZ10
◀ 351 ▶



Kanlux HLDR-G7S
◀ 351 ▶



Kanlux
HLDR-E14/GU10
◀ 352 ▶



Kanlux
HLDR-E27/GU10
◀ 353 ▶



Kanlux STRAP
◀ 353 ▶



Kanlux Itech
◀ 354 ▶



Kanlux BOA
◀ 355 ▶



Kanlux ONTEC S
◀ 356 ▶



Kanlux ONTEC S
◀ 357 ▶



Kanlux ONTEC S
◀ 357 ▶



Kanlux ONTEC R
◀ 358 ▶



Kanlux ONTEC G
◀ 359 ▶

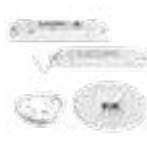

Kanlux ONTEC C
◀ 359 ▶



Kanlux VIP
◀ 360 ▶



Kanlux PICTO ONTEC
◀ 362-363 ▶



Kanlux IT
◀ 364 ▶



Kanlux





Kanlux
FACTORY

OPRAWY Z FABRYKI KANLUX
KANLUX FACTORY FIXTURES

Nasze kompletne rozwiązania możemy dostosować specjalnie do Twoich potrzeb. Dbłość o każdy szczegół i idealne dopasowanie to właśnie produkty z Fabryki Kanlux. Poznaj je już dziś!

Our complete solutions can be adjusted to your needs. Attention to every detail and perfect fit are what characterises Kanlux Factory products. Discover them today!



*dane fotometryczne znajdziesz na:
photometric data you can find on:*

► [kanlux.com](https://www.kanlux.com)

ALIN LED

OPRAWA LINIOWA LED ► LINEAR LIGHTING FIXTURES



ALIN LED ... PT

ALIN LED ... NT



Kanlux ALIN LED to produkt, który powstał z myślą o oprawie idealnej. Stworzyli go projektanci Kanlux, którzy połączyli innowację z 30-letnim doświadczeniem. Markowe komponenty i perfekcyjne wykonanie zapewniają estetykę i trwałość działania przez długie lata. Szeroka oferta modeli daje możliwość dopasowania oprawy do potrzeb każdej inwestycji.

5 lat Gwarancji na warunkach oświadczenia gwarancyjnego, dostępnego na stronie internetowej: www.kanlux.com

The Kanlux ALIN LED is a product which was created with a view to a perfect fixture. It was created by the Kanlux designers, who combined innovation with 30 years of experience. Their branded components and perfect workmanship ensure the aesthetics and durability of operation for many years. The wide range of models affords the possibility to adjust the fixture to the needs of each investment.

5 years Warranty under the terms of the warranty statement, available on our website: www.kanlux.com

CONFIGURATOR



Wyprodukujemy dla Ciebie oprawę idealną. Stwórz ją z pomocą naszego konfiguratora.

We will produce a perfect luminaire for you. Create it with our configurator.

TRZY DŁUGOŚCI
THREE LENGTHS

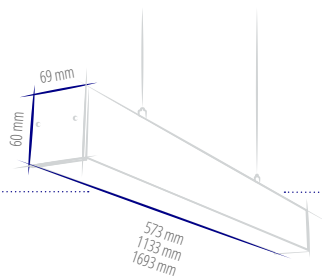

CO NAS WYRÓŻNIA?

TRZY WERSJE
THREE VERSIONS

TRZY KOLORY OBUDOWY
THREE HOUSING COLORS

DWIE BARWY ŚWIATŁA
TWO COLOR TEMPERATURES

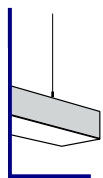

ZWIESZANA
SUSPENDED
MOUNTED

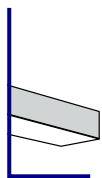

NATYNKOWA
SURFACE
MOUNTED

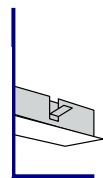

PODTYNKOWA
RECESSED
MOUNTED



BIAŁY
WHITE



CZARNY
BLACK



SREBNY
SILVER



CIĘPŁO BIAŁA
WARM WHITE

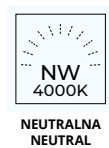

NEUTRALNA
NEUTRAL

LEGENDA ► KEY

AL	KANLUX ALIN LED
ALD	KANLUX ALIN LED DALI
11W-50W	moc [W] / power [W]
830	Ra ≥ 80 3000K
840	Ra ≥ 80 4000K
MAT	klosz matowy / matt lampshade
MPR	klosz mikropryzmatyczny / microprismatic lampshade
RST	raster / louvre
W	kolor obudowy: biały / housing colour: white
B	kolor obudowy: czarny / housing colour: black
SR	kolor obudowy: srebrny / housing colour: silver
PT	wersja podtynkowa / recessed mounted
NT	wersja natynkowa / surface-mounted

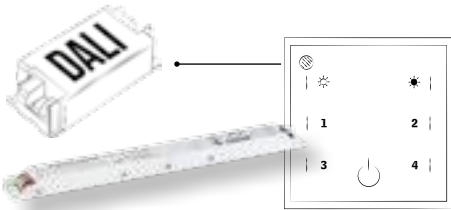

OPCJONALNIE STEROWANIE DALI
DALI LED DRIVER AVAILABLE
AS AN OPTION

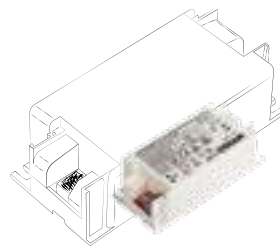

ZASILACZ
MARKI OSRAM
POWER SUPPLY
BY OSRAM



WYSOKIEJ JAKOŚCI
MODUŁ LED
HIGH QUALITY
LED MODULE

WHAT MAKES US DIFFERENT?

TRZY RODZAJE DYFUZORA
THREE TYPES OF DIFFUSER

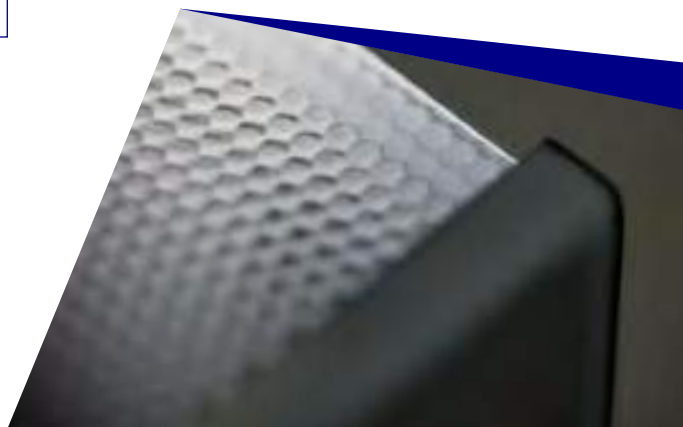
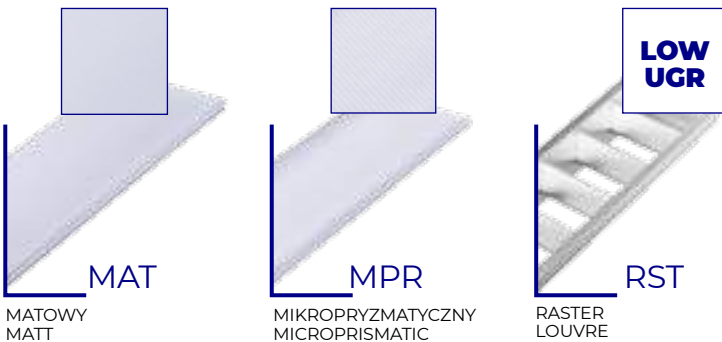

ALIN LED LINE

OPRAWA LINIOWA LED ► LINEAR LIGHTING FIXTURES

NIEOGRANICZONA DŁUGOŚĆ
LINII ŚWIETLNEJ
UNLIMITED LENGTH
OF LIGHT LINE

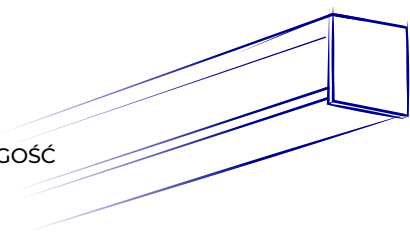

Kanlux ALIN LED LINE to innowacyjny system oświetleniowy stworzony w oparciu o idealnie dopracowane oprawy Kanlux ALIN LED. Rozwiązanie to pozwala na stworzenie długich linii świetlnych o prostych lub niestandardowych kształtach. Pełne dopasowanie do konkretnej inwestycji daje możliwości osiągnięcia niepowtarzalnego efektu przy każdej realizacji z użyciem Kanlux ALIN LED LINE.

5 lat Gwarancji na warunkach oświadczenia gwarancyjnego, dostępnego na stronie internetowej: www.kanlux.com

Kanlux ALIN LED LINE is an innovative lighting system created based on perfectly prepared Kanlux ALIN LED luminaires. This solution allows for creating long light lines with straight or custom shapes. Full adaptation to the specific investment enables creation of a unique effect in each project using Kanlux ALIN LED LINE.

5 years Warranty under the terms of the warranty statement, available on our website: www.kanlux.com

CONFIGURATOR



Wyprodukujemy dla Ciebie oprawę idealną. Stwórz ją z pomocą naszego konfiguratora.

We will produce a perfect luminaire for you. Create it with our configurator.

TRZY WERSJE
THREE VERSIONS

TRZY KOLORY OBUDOWY
THREE HOUSING COLORS

DWIE BARWY ŚWIATŁA
TWO COLOR TEMPERATURES

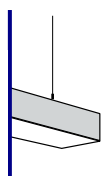

ZWIESZANA
SUSPENDED
MOUNTED

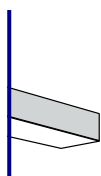

NATYNKOWA
SURFACE
MOUNTED

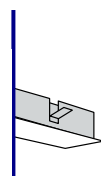

PODTYNKOWA
RECESSED
MOUNTED



BIAŁY
WHITE



CZARNY
BLACK



SREBNY
SILVER



CIĘPŁO BIAŁA
WARM WHITE



NEUTRALNA
NEUTRAL

LEGENDA ► KEY

LF	element początkowy / first component
LM	element środkowy / middle component
LL	element końcowy / last component
LFD	element początkowy DALI / first component DALI
LMD	element środkowy DALI / middle component DALI
LLD	element końcowy DALI / last component DALI
830	Ra ≥ 80 3000K
840	Ra ≥ 80 4000K
MAT	klosz matowy / matt lampshade
MPRM	klosz mikropryzmatyczny / microprismatic lampshade
W	kolor obudowy: biały / housing colour: white
B	kolor obudowy: czarny / housing colour: black
SR	kolor obudowy: srebrny / housing colour: silver
PT	wersja podtynkowa / recessed mounted
NT	wersja natynkowa / surface-mounted



OPCJONALNIE STEROWANIE DALI
DALI LED DRIVER AVAILABLE
AS AN OPTION

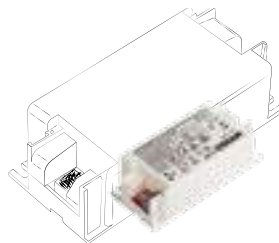
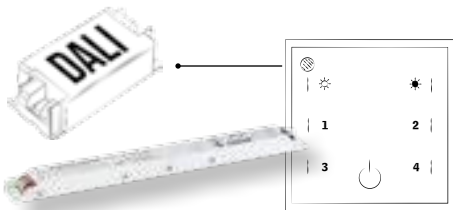

ZASILACZ
MARKI OSRAM
POWER SUPPLY
BY OSRAM

WYSOKIEJ JAKOŚCI
MODUŁ LED
HIGH QUALITY
LED MODULE

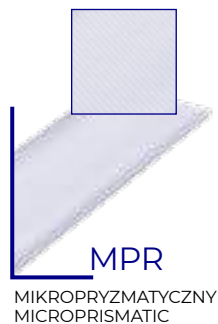

DWA RODZAJE
DYFUZORA
TWO TYPES OF
DIFFUSER

Kanlux

ALIN 4LED

OPRAWA LINIOWA POD TUBY T8 LED ► T8 LED TUBE LINEAR FITTINGS



ALIN 4LED ... NT

UNIKALNA LINIA ŚWIETLNA
UNIQUE LIGHTING LINE

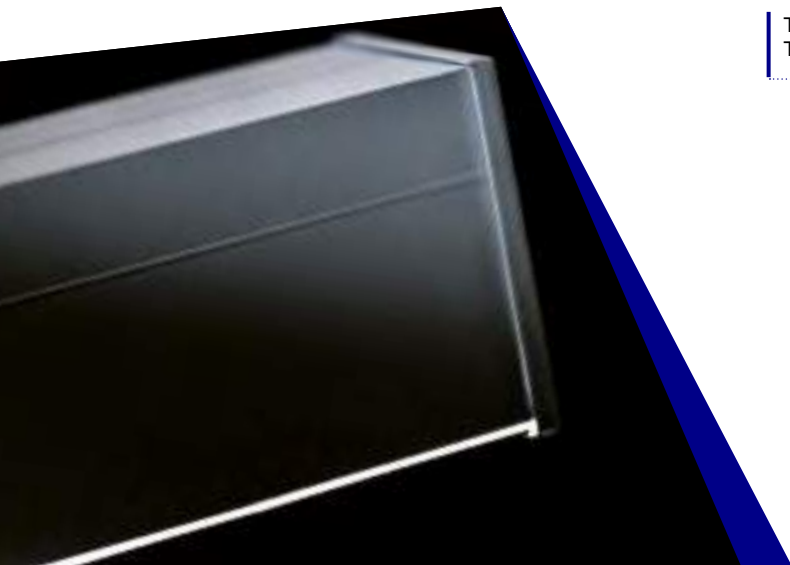

Kanlux
FACTORY



Kanlux ALIN 4LED to oprawa dostosowana do tub T8 LED. To rozwiązanie dla tych, którzy cenią sobie wymienne źródło światła. Markowe komponenty i perfekcyjne wykonanie zapewniają estetykę i trwałość działania przez długie lata. Szeroka oferta modeli daje możliwość dopasowania oprawy do potrzeb każdej inwestycji.



5 lat Gwarancji na warunkach oświadczenia gwarancyjnego, dostępnego na stronie internetowej: www.kanlux.com

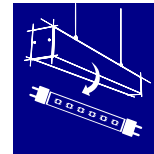

The Kanlux ALIN 4LED is a fixture adapted to T8 LED fluorescent lamps. It is a solution for those who appreciate a replaceable light source. The branded components and perfect workmanship ensure the aesthetics and durability of operation for many years. The wide range of models affords the possibility to adjust the fixture to the needs of each investment.

5 years Warranty under the terms of the warranty statement, available on our website: www.kanlux.com

CONFIGURATOR



Wyprodukujemy dla Ciebie oprawę idealną. Stwórz ją z pomocą naszego konfiguratora.

We will produce a perfect luminaire for you. Create it with our configurator.



CO NAS WYRÓŻNIA?

TRZY DŁUGOŚCI OPRAWY
THREE LENGTHS

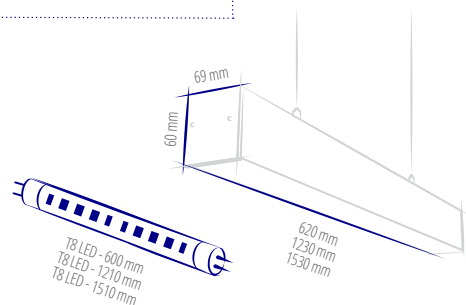

LEGENDA ► KEY

AL 4LED	KANLUX ALIN 4LED
MAT	klosz matowy / matt lampshade
MPR	klosz mikropryzmatyczny / microprismatic lampshade
W	kolor obudowy: biały / housing colour: white
B	kolor obudowy: czarny / housing colour: black
SR	kolor obudowy: srebrny / housing colour: silver
NT	wersja natynkowa / surface-mounted

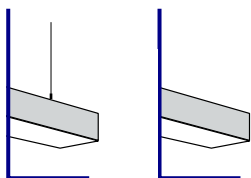

ZWIESZANA
SUSPENDED
MOUNTED

NATYNKOWA
SURFACE
MOUNTED

DWIE WERSJE
TWO VERSIONS



BIAŁY
WHITE



CZARNY
BLACK



SREBNY
SILVER

TRZY KOLORY OBUDOWY
THREE HOUSING COLORS

WHAT MAKES US DIFFERENT?

DWA RODZAJE DYFUZORA
TWO TYPES OF DIFFUSER

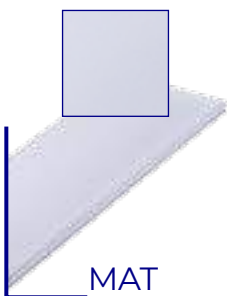

MATOWY
MATT

MAT

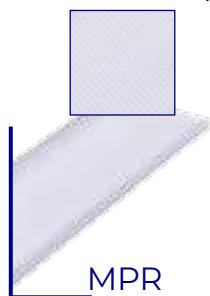

MIKROPRYZMATYCZNY
MICROPRISMATIC

MPR

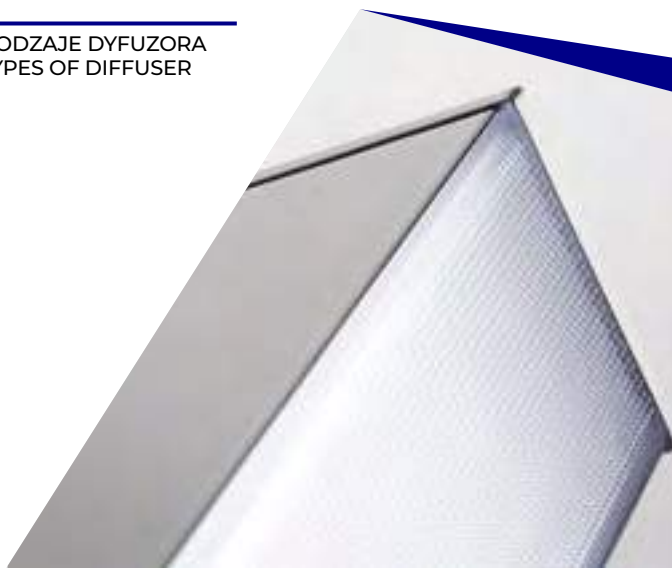

OFIS LED

OPRAWA BIUROWA LED ► LED OFFICE FIXTURE



Kanlux OFIS LED to rodzina nowoczesnych opraw biurowych z wieloma udogodnieniami do indywidualnego wyboru. Dzięki zastosowaniu unikatowych modułów LED oprawy gwarantują równomierny rozsył światła, a możliwość wyboru dyfuzora spośród kilku dostępnych modeli pozwala na osiągnięcie ciekawych efektów wizualnych.



5 lat Gwarancji na warunkach oświadczenia gwarancyjnego, dostępnego na stronie internetowej: www.kanlux.com



The Kanlux OFIS LED is a family of modern office fixtures with many options for individual choice. Thanks to the use of unique LED modules, the fixtures guarantee uniform light distribution, and the possibility of choosing a diffuser from among several available models allows you to achieve interesting visual effects.



5 years Warranty under the terms of the warranty statement, available on our website: www.kanlux.com

CONFIGURATOR



Wyprodukujemy dla Ciebie oprawę idealną. Stwórz ją z pomocą naszego konfiguratora.

We will produce a perfect luminaire for you. Create it with our configurator.

DWIE WERSJE TWO VERSIONS

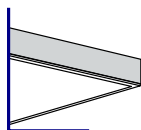

NATYNKOWA
SURFACE MOUNTED

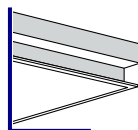

PODTYNKOWA
RECESSED MOUNTED

WYMIARY SIZE



615mm x 295mm



595mm x 595mm



615mm x 615mm



1225mm X 295mm



CIEPŁO BIAŁA
WARM WHITE



NEUTRALNA
NEUTRAL

DWIE BARWY ŚWIATŁA TWO COLOR TEMPERATURES



LEGENDA ► KEY

OF	OFIS LED
OFD	OFIS LED DALI
17W - 64W	moc [W] power [W]
830	Ra≥80 3000K
840	Ra≥80 4000K
MAT	mleczny / opalowy dyfuzor milky / opal diffuser
MPRM	mikropryzmatyczny dyfuzor typu M microprismatic diffuser type M
MPRD	mikropryzmatyczny dyfuzor typu D microprismatic diffuser type D
W	kolor obudowy: biały colour of housing: white
N1	wersja natynkowa 615x615 surface mounted 615x615
N2	wersja natynkowa 615x295 surface mounted 615x295
N3	wersja natynkowa 1225x295 surface mounted 1225x295
P1	wersja podtynkowa 595x595 recessed mounted 595x595



MARKOWE SPECJALNIE
WYSELEKCYJONOWANE LED
SPECIALLY SELECTED
LED CHIPS



ZASILACZ
TRIDONIC
TRIDONIC
DRIVER

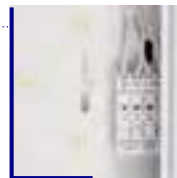

SZYBKI
MONTAŻ
QUICK
INSTALLATION

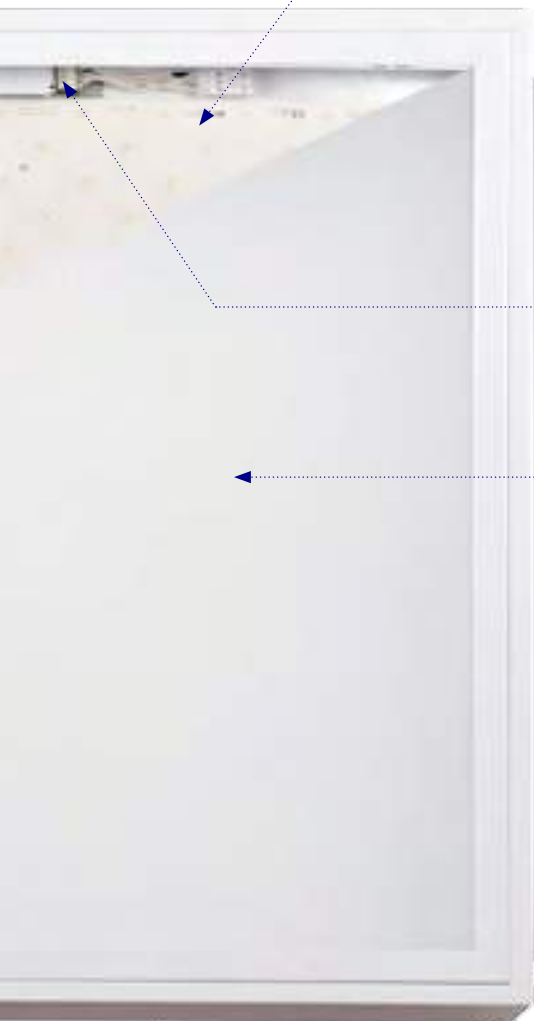

OPCJONALNIE
STEROWANIE DALI
DALI LED DRIVER
AVAILABLE
AS AN OPTION

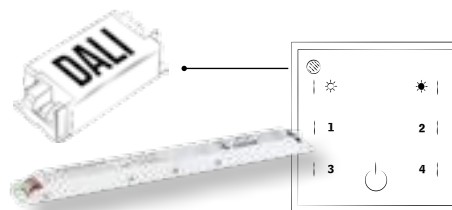

TRZY RODZAJE
DYFUZORA
THREE TYPES
OF DIFFUSER



mleczny / opalowy
milky / opal

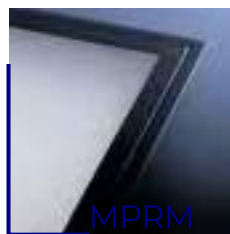

mikropryzmatyczny typu M
microprismatic type M



mikropryzmatyczny typu D
microprismatic type D

**LOW
UGR**

OFIS S LED

OPRAWA BIUROWA LED ► LED OFFICE FIXTURE



OFIS S LED ... NT...N1



OFIS S LED ... NT...N3



OFIS S LED ... PT...P1



OFIS S LED ... PT...P3



Kanlux OFIS S LED to seria nowoczesnych opraw przeznaczonych przede wszystkim do powierzchni biurowych. Prosta, wyjątkowo płaska obudowa czyni oprawę bardzo elegancką dzięki czemu idealnie wpisuje się ona w płaszczyznę sufitu. Możliwość wyboru koloru obudowy, dyfuzora oraz temperatury barwowej czyni ją wyjątkowo wszechstronną, a unikatowa konstrukcja maksymalnie przyspiesza montaż.

5 lat Gwarancji na warunkach oświadczenia gwarancyjnego, dostępnego na stronie internetowej: www.kanlux.com

Kanlux OFIS S LED is a series of modern luminaires intended primarily for office spaces. The simple, extremely flat casing makes the luminaire very elegant so it blends perfectly into the ceiling plane. The possibility of selecting the casing colour, the diffuser and the colour temperature makes it eminently versatile, and the unique design accelerates assembly to the maximum.

5 years Warranty under the terms of the warranty statement, available on our website: www.kanlux.com

CONFIGURATOR



Wyprodukujemy dla Ciebie oprawę idealną. Stwórz ją z pomocą naszego konfiguratora.

We will produce a perfect luminaire for you. Create it with our configurator.

MARKOWE DIODY I ZASILACZE OSRAM/TRIDONIC
BRANDED LEDS AND OSRAM/TRIDONIC DRIVERS



DWIE WERSJE
TWO VERSIONS

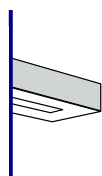

NATYNKOWA
SURFACE
MOUNTED

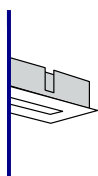

PODTYNKOWA
RECESSED
MOUNTED

DWA KOLORY OBUDOWY
TWO HOUSING
COLORS



BIAŁY
WHITE



CZARNY
BLACK

DWIE BARWY
ŚWIATEŁA
TWO COLOR
TEMPERATURES



CIEPŁO BIAŁA
WARM WHITE



NEUTRALNA
NEUTRAL

LEGENDA ► KEY

OS	OFIS S LED
OSD	OFIS S LED DALI
40W	moc [W] power [W]
830	Ra≥80 3000K
840	Ra≥80 4000K
MAT	klosz matowy / matt lampshade
MPRM	klosz mikropryzmatyczny / microprismatic lampshade
W	kolor obudowy: biały housing colour: white
B	kolor obudowy: czarny housing colour: black
N1	wersja natynkowa 600x600 surface mounted 600x600
N3	wersja natynkowa 1200x300 surface mounted 1200x300
P1	wersja podtynkowa 595x595 recessed mounted 595x595
P3	wersja podtynkowa 1195x295 recessed mounted 1195x295

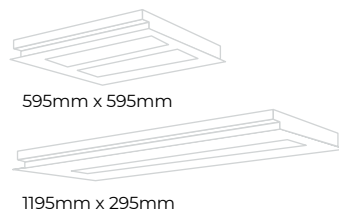
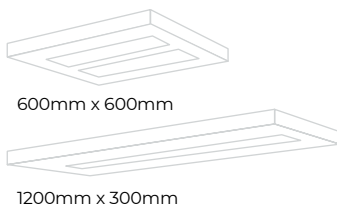

WYMIARY
SIZE

OPCJONALNIE
STEROWANIE DALI
DALI LED DRIVER
AVAILABLE
AS AN OPTION

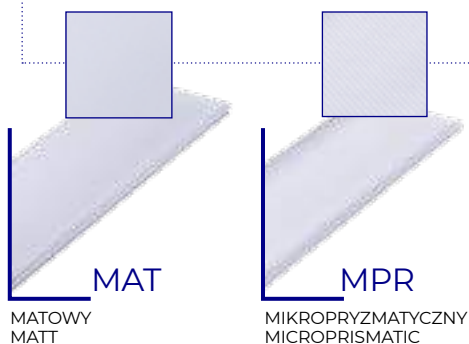
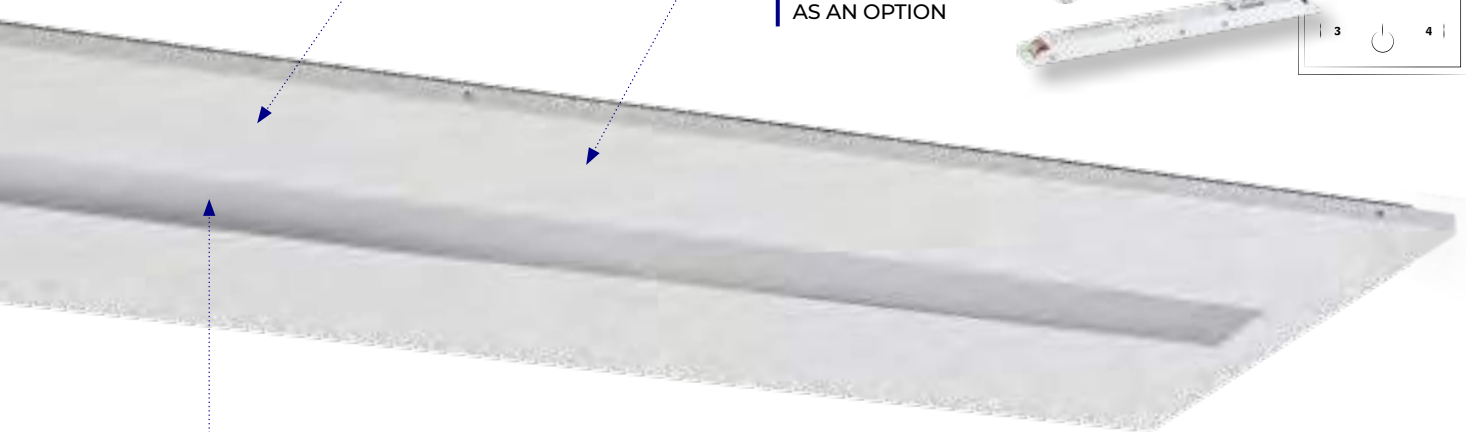
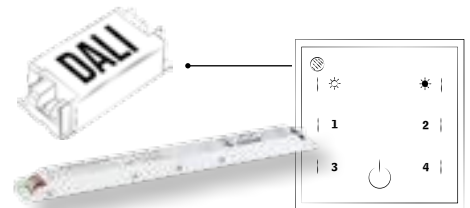

DWA RODZAJE
DYFUZORA
TWO TYPES OF
DIFFUSER

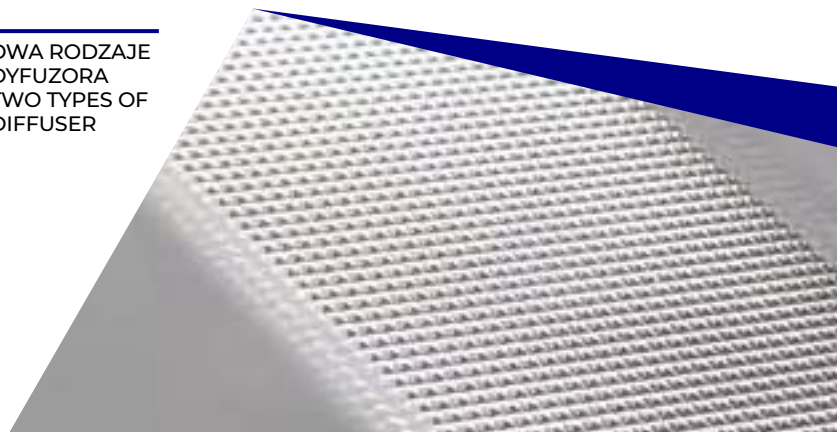

FUTURIO LED

OPRAWA PYŁOSZCZELNA LED ► LED DUSTPROOF LIGHTING FITTING



Kanlux FUTURIO LED to seria opraw hermetycznych, która produkowana jest w fabryce Kanlux. Wyróżnia je wysoka jakość wykonania oraz imponujące parametry. Kanlux FUTURIO LED to również szybki i łatwy montaż. Szeroka oferta modeli daje możliwość dopasowania oprawy do potrzeb każdej inwestycji. Dostępne są również wersje specjalistyczne: do zastosowania w wysokich temperaturach lub o wysokim strumieniu świetlnym.

5 lat Gwarancji na warunkach oświadczenia gwarancyjnego, dostępnego na stronie internetowej: www.kanlux.com

The Kanlux FUTURIO LED is a series of hermetic fixtures which is produced in the Kanlux factory. They are distinguished by high quality of workmanship and impressive parameters. The Kanlux FUTURIO LED is also quick and easy to install. A wide range of models affords the possibility to adjust the fixture to the needs of each investment. Specialist versions are also available: for high-temperature applications or with high luminous flux.

5 years Warranty under the terms of the warranty statement, available on our website: www.kanlux.com

CONFIGURATOR



Wyprodukujemy dla Ciebie oprawę idealną. Stwórz ją z pomocą naszego konfiguratora.

We will produce a perfect luminaire for you. Create it with our configurator.

MARKOWE DIODY I ZASILACZE OSRAM/TRIDONIC
BRANDED LEDS AND OSRAM/TRIDONIC DRIVERS



DWIE DŁUGOŚCI
TWO LENGTHS

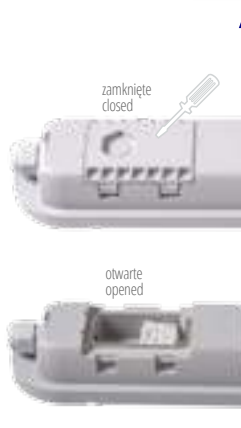
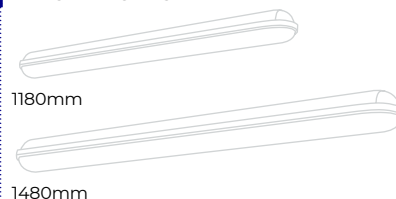

SZYBKA INSTALACJA
BEZ KONIECZNOŚCI
OTWIERANIA OPRAWY
EASY MOUNTING
WITHOUT THE
NECESSITY OF OPENING
THE FIXTURE

MOŻLIWOŚĆ REGULACJI
ZA POMOCĄ UCHWYTÓW
MONTAŻOWYCH
ADJUSTABLE MOUNTING
BRACKET



MOŻLIWOŚĆ
ŁĄCZENIA W LINIE
POSSIBILITY OF
LINEAR CONNECTION



LEGENDA ► KEY

FT	FUTURIO LED
FTD	FUTURIO LED DALI
28W - 73W	moc [W] power [W]
840	Ra≥80 4000K
OPL	klosz opalowy opal lamshade
RYF	klosz ze strukturą pryzmatyczną prismatic structure lamshade
INT	soczewka wąskostrumieniowa narrow beam angle lens
ASY	soczewka asymetryczna asymmetrical beam angle lens
FTHL	wersja specjalna o wysokim strumieniu świetlnym special version with high lumen
FTHT	wersja specjalna do pracy w wyższych temperaturach special version to work with high temperature



OPCJONALNIE STEROWANIE DALI
DALI LED DRIVER AVAILABLE AS AN OPTION

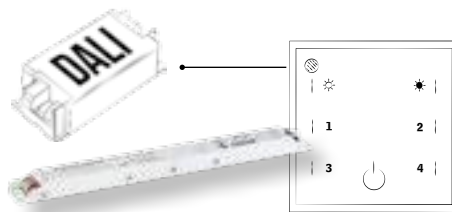

IP 65
IK 08



DWIE WERSJE Z SOCZEWKAMI
TWO MODELS WITH LENSES



INTENSE
wąskostrumieniowy
narrow beam angle



ASY
asymetryczny
asymmetric beam angle

DWA RODZAJE KLOSZY
TWO TYPES OF LAMP SHADES



RYF
ze strukturą pryzmatyczną
prismatic structure



OPL
opalowy
opal

Kanlux FACTORY

Pozwól, że rozświetlimy
Twoją firmę

Kanlux FACTORY

Let us light up your
company



Kanlux
FACTORY
CONFIGURATOR

**Dopasujemy światło
do Twoich potrzeb
We will match the light
with your needs**



**SAM KONFIGURUJ IDEALNĄ OPRAWĘ
CONFIGURE THE PERFECT LUMINAIRE ON YOUR OWN**

DŁUGOŚĆ
LENGTH

KLOSZ
LAMPSHADE

TEMPERATURA BARWOWA
COLOR TEMPERATURE

MOC
POWER

KOLOR
COLOUR

SPOSÓB MONTAŻU
ASSEMBLY



Kanlux **ALIN**



Kanlux **FUTURIO**



Kanlux **OFIS**



Kanlux **OFIS S**



Wyprodukujemy dla Ciebie
oprawę idealną. Stwórz ją
z pomocą naszego konfiguratora.

We will produce a perfect
luminaire for you. Create it
with our configurator.



kanlux.com ►

Kanlux



ŹRÓDŁA ŚWIATŁA

LIGHT SOURCES

Zależy Ci na tym aby produkty, którymi się otaczasz były bezpieczne i trwałe.

Dbamy o to podczas produkcji i w naszym laboratorium Kanlux. Mamy pewność, że oddajemy w Twoje ręce produkt całkowicie bezpieczny i spełniający Twoje wymagania.

You want the products around you to be safe and durable. We take care of all of this it during the production and in our Kanlux laboratory.

We are sure that we give you a product that is completely safe and meets your requirements.



*dane fotometryczne znajdziesz na:
photometric data you can find on:*

► [kanlux.com](https://www.kanlux.com)

IQ-LED A60

ŹRÓDŁO ŚWIATŁA LED ▶ LED LIGHT SOURCE



IQ-LED A60 5,5W, IQ-LED A60 9W, IQ-LED A60 10,5W



IQ-LED A60 5,5W, IQ-LED A60 9W
IQ-LED A60 10,5W



IQ-LED A60 14W



Kanlux IQ-LED to bezpieczeństwo fotobiologiczne, przyjazna oczom temperatura barwowa i niezawodność, a to wszystko zachowane w klasycznym designie A60. Żarówki IQ-LED zapewniają pełen komfort użytkowania oraz bezpieczeństwo, które potwierdza certyfikat TÜV Rheinland.

Materiał: tworzywo sztuczne

Materiał klosza: tworzywo sztuczne

The Kanlux IQ-LED means photobiological safety and eye-friendly colour temperature and reliability, all in the classic A60 design. IQ-LED bulbs provide full comfort of use and safety, which is confirmed by the TÜV Rheinland certificate.

Materiał: plastic

Lampshade material: plastic



Model	Code	Power [W]	Frequency [Hz]	Beam Angle [°]	Color Temp [K]	Light Output [lm]	Life [h]	Base
IQ-LED A60 5,5W-WW	27270	5,5	40	470	2700	240	E27	
IQ-LED A60 5,5W-NW	27271	5,5	41	480	4000	240	E27	
IQ-LED A60 5,5W-CW	27272	5,5	41	480	6500	240	E27	
IQ-LED A60 9W-WW	27273	9	60	810	2700	220	E27	
IQ-LED A60 9W-NW	27274	9	60	810	4000	220	E27	
IQ-LED A60 9W-CW	27275	9	60	810	6500	220	E27	
IQ-LED A60 10,5W-WW	27276	10,5	75	1060	2700	220	E27	
IQ-LED A60 10,5W-NW	27277	10,5	76	1080	4000	220	E27	
IQ-LED A60 10,5W-CW	27278	10,5	76	1080	6500	220	E27	
IQ-LED A60 14W-WW	27279	14	100	1520	2700	200	E27	
IQ-LED A60 14W-NW	27280	14	103	1580	4000	200	E27	
IQ-LED A60 14W-CW	27281	14	103	1580	6500	200	E27	

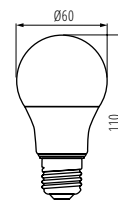

IQ-LED A60 5,5W, IQ-LED A60 9W
IQ-LED A60 10,5W

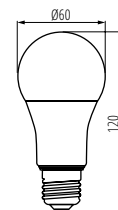

IQ-LED A60 14W



Kanlux

IQ-LED A67

ŹRÓDŁO ŚWIATEŁA LED ► LED LIGHT SOURCE

NEW



IQ-LED A67 17,5W, IQ-LED A67 19W



IQ-LED A67 17,5W



IQ-LED A67 19W



Safety
Regular
Production
Surveillance

www.tuv.com
ID 0000055711



Kanlux IQ-LED to bezpieczeństwo fotobiologiczne, przyjazna oczom temperatura barwowa i niezawodność, a to wszystko w nowej, dużej bańce A67. Żarówki IQ-LED zapewniają pełen komfort użytkowania oraz bezpieczeństwo, które potwierdza certyfikat TÜV Rheinland.

Materiał klosza: tworzywo sztuczne

Kanlux IQ-LED means photo-biological safety, colour temperature friendly to eyes and reliability and all this in a new, large bulb A67. IQ-LED bulbs ensure full comfort of use and safety, which is confirmed by TÜV Rheinland certificate.

Lampshade material: plastic

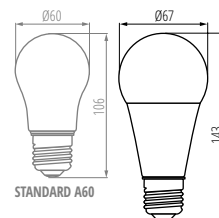

IQ-LED A67 17,5W

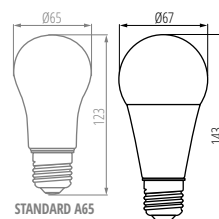

IQ-LED A67 19W

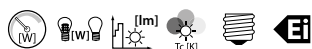

IQ-LED A67 17,5W-WW	27312	5905339273123	17,5	121	1920	2700	E27	A+
IQ-LED A67 17,5W-NW	27313	5905339273130	17,5	126	2000	4000	E27	A+
IQ-LED A67 17,5W-CW	27314	5905339273147	17,5	126	2000	6500	E27	A+
IQ-LED A67 19W-WW	27315	5905339273154	19	150	2450	2700	E27	A++
IQ-LED A67 19W-NW	27316	5905339273161	19	157	2600	4000	E27	A++
IQ-LED A67 19W-CW	27317	5905339273178	19	157	2600	6500	E27	A++

[V]	[Hz]	[SMD]	[Flicker-free]	[CRI]	[Lifetime]	[Mercury-free]	[RoHS]	[CE]	[ENEC]
220-240 AC	50/60	SMD	≤ 0,1 Nachleuchten	≥ 80	≥ 40000	15000			

IQ-LEDDIM A60

ŹRÓDŁO ŚWIATŁA LED ▶ LED LIGHT SOURCE



IQ-LEDDIM A60 5,5W, IQ-LEDDIM A60 8,5W



IQ-LEDDIM A60 5,5W, IQ-LEDDIM A60 8,5W



IQ-LEDDIM A60 12,5W, IQ-LEDDIM A60 15W



Kanlux IQ-LED to bezpieczeństwo fotobiologiczne, przyjazna oczom temperatura barwowa i niezawodność. Teraz to wszystko w nowej wersji z trzonkiem E27 - dodatkowo wersja IQ-LEDDIM współpracuje ze ściemniaczami. Żarówki IQ-LED zapewniają pełen komfort użytkowania oraz bezpieczeństwo, które potwierdza certyfikat TÜV Rheinland.

Material: tworzywo sztuczne

Kanlux IQ-LED means photo-biological safety, colour temperature friendly to eyes and reliability. Now, all this in a new version with E27 light bulb base - additionally, the IQ-LEDDIM version cooperates with dimmers. IQ-LED bulbs ensure full comfort of use and safety, which is confirmed by TÜV Rheinland certificate.

Material: plastic



	[V]	[Hz]	SMD	Ra	≥80	≥40000	Hg	Ei	A+	CE	EAC
IQ-LEDDIM A60 5,5W-WW	27282	5905339272829	5,5	40	470	2700	240	E27	25000		
IQ-LEDDIM A60 5,5W-NW	27283	5905339272836	5,5	42	500	4000	240	E27	25000		
IQ-LEDDIM A60 5,5W-CW	27284	5905339272843	5,5	42	510	6500	240	E27	25000		
IQ-LEDDIM A60 8,5W-WW	27285	5905339272850	8,5	60	810	2700	240	E27	25000		
IQ-LEDDIM A60 8,5W-NW	27286	5905339272867	8,5	63	850	4000	240	E27	25000		
IQ-LEDDIM A60 8,5W-CW	27287	5905339272874	8,5	64	880	6500	240	E27	25000		
IQ-LEDDIM A60 12,5W-WW	27288	5905339272881	12,5	75	1060	2700	240	E27	25000		
IQ-LEDDIM A60 12,5W-NW	27289	5905339272898	12,5	77	1100	4000	240	E27	25000		
IQ-LEDDIM A60 12,5W-CW	27290	5905339272904	12,5	77	1100	6500	240	E27	25000		
IQ-LEDDIM A60 15W-WW	27291	5905339272911	15	100	1520	2700	240	E27	15000		
IQ-LEDDIM A60 15W-NW	27292	5905339272928	15	103	1580	4000	240	E27	15000		
IQ-LEDDIM A60 15W-CW	27293	5905339272935	15	103	1580	6500	240	E27	15000		

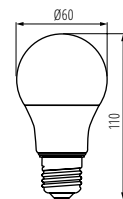

IQ-LEDDIM A60 5,5W, IQ-LEDDIM A60 8,5W

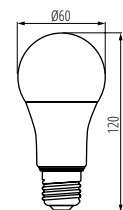

IQ-LEDDIM A60 12,5W, IQ-LEDDIM A60 15W

Kanlux

XLED A60

ŹRÓDŁO ŚWIATŁA LED ► LED LIGHT SOURCE

NEW



XLED A60 4,5W



XLED A60 4,5W



XLED A60 7W



XLED A60 8W; 10W



Kanlux XLED łączy w sobie najlepsze cechy tradycyjnych żarówek i nowoczesnych źródeł światła LED. Dlatego mówimy o nim, że to pierwsza prawdziwa „żarówka LED”. Szklana bańka w kształcie tradycyjnej żarówki i diody LED rozmieszczone w taki sposób, że światło rozchodzi się we wszystkich kierunkach, a kąt świecenia wynosi nawet 320 stopni!

Materiał klosza: szkło

Kanlux XLED combines the best features of traditional bulbs and modern LED light sources. Therefore, we talk about it as the first real LED bulb. A glass bulb in the shape of a traditional bulb and LED diodes placed in such a way so that light can part in all directions, and the angle of light comes to even 320 degrees!

Lampshade material: glass

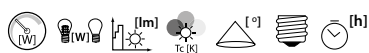

	[W]	[Hz]	FILAMENT	ellipse ≤ 60 MacAdam	Ra ≥ 80	≥ 15000	Hg	RoHS	CE	ErC							
XLED A60 4,5W-WW	29600	5905339296009	4,5	40	470	2700	320	E27	15000								
XLED A60 7W-WW	29601	5905339296016	7	60	810	2700	320	E27	15000								
XLED A60 7W-NW	29602	5905339296023	7	60	810	4000	320	E27	15000								
XLED A60 7W-CW	29603	5905339296030	7	60	810	6500	320	E27	15000								
XLED A60 8W-WW	29604	5905339296047	8	75	1055	2700	320	E27	15000								
XLED A60 10W-WW	29605	5905339296054	10	100	1520	2700	320	E27	10000								
XLED A60 10W-NW	29606	5905339296061	10	100	1520	4000	320	E27	10000								

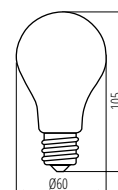

XLED A60 4,5W; 7W; 8W; 10W



Kanlux

XLED A60M

ŹRÓDŁO ŚWIATŁA LED ► LED LIGHT SOURCE

NEW



XLED A60M 4,5W, XLED A60M 7W,
XLED A60M 8W, XLED A60M 10W



Kanlux XLED łączy w sobie najlepsze cechy tradycyjnych żarówek i nowoczesnych źródeł światła LED. Matowa banka w kształcie tradycyjnej żarówki i diody LED rozmieszczone w taki sposób, że światło rozchodzi się we wszystkich kierunkach, a kąt świecenia wynosi nawet 320 stopni!

Materiał klosza: szkło

Kanlux XLED combines the best features of traditional bulbs and modern LED light sources. A matt bulb in the shape of a traditional bulb and LED diodes placed in such a way so that light can part in all directions, and the angle of light comes to even 320 degrees!

Lampshade material: glass



	[W]	[lm]	[°]	[h]	[Ra]	[Hg]	[A]	[CE]	[EAC]
XLED A60 4,5W-WW-M	29607	5905339296078	4,5	40	470	2700	320	E27	15000
XLED A60 4,5W-NW-M	29608	5905339296085	4,5	40	470	4000	320	E27	15000
XLED A60 7W-WW-M	29609	5905339296092	7	60	810	2700	320	E27	15000
XLED A60 7W-NW-M	29610	5905339296108	7	60	810	4000	320	E27	15000
XLED A60 7W-CW-M	29611	5905339296115	7	60	810	6500	320	E27	15000
XLED A60 8W-WW-M	29612	5905339296122	8	75	1055	2700	320	E27	15000
XLED A60 8W-NW-M	29613	5905339296139	8	75	1055	4000	320	E27	15000
XLED A60 8W-CW-M	29614	5905339296146	8	75	1055	6500	320	E27	15000
XLED A60 10W-WW-M	29615	5905339296153	10	100	1520	2700	320	E27	10000
XLED A60 10W-NW-M	29616	5905339296160	10	100	1520	4000	320	E27	10000

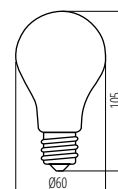

XLED A60M 4,5W, XLED A60M 7W, XLED A60M 8W,
XLED A60M 10W

[V]	[Hz]	FILAMENT	ellipso ≤60 MacAdam	Ra	≥80	≥15000	Hg		CE	EAC
220-240 AC	50/60								A**	

Kanlux

XLED STEPDIM

ŹRÓDŁO ŚWIATŁA LED ► LED LIGHT SOURCE

NEW



XLEDA60 7W-STEPDIM

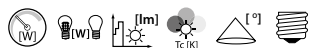

XLEDA60 7W-WW-STEPDIM	29634	5905339296344	7	60	810	2700	320	E27
XLEDA60 7W-NW-STEPDIM	29635	5905339296351	7	60	810	4000	320	E27

[V]	[Hz]	FILAMENT	ellipse ≤ 60 MacAdam	Ra	≥ 15000	[h]	15000	Hg	RoHS	A++	CE	ERAC
220-240 AC	50/60			≥ 80								

STEP DIMMING FUNCTION

1x CLICK 100%
2x CLICK 50%
3x CLICK 7%



Kanlux XLED łączy w sobie najlepsze cechy tradycyjnych żarówek i nowoczesnych źródeł światła LED. Dlatego mówimy o nim, że to pierwsza prawdziwa „żarówka LED”. Szklana bańka w kształcie tradycyjnej żarówki i diody LED rozmieszczone w taki sposób, że światło rozchodzi się we wszystkich kierunkach. Dodatkowo w wersji STEPDIM możemy zmniejszać stopniowo strumień świetlny bez dodatkowego ściemniacza.

Materiał klosza: szkło

Kanlux XLED combines the best features of traditional bulbs and modern LED light sources. Therefore, we talk about it as the first real LED bulb. A glass bulb in the shape of a traditional bulb and LED diodes placed in such a way so that light can part in all directions. Additionally, in the STEPDIM version you can gradually reduce the light stream without an additional dimmer.

Lampshade material: glass

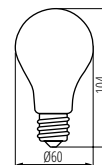

XLED A60 7W-STEPDIM

Kanlux

XLED CCT

ŹRÓDŁO ŚWIATŁA LED ► LED LIGHT SOURCE

NEW



XLED A60 7W-STEP CCT



XLED A60 7W-STEP CCT	29636	5905339296368	7	60	810	2700/4000/6500	320	E27
----------------------	--------------	---------------	---	----	-----	----------------	-----	-----

[V]	[Hz]	FILAMENT	ellipse ≤ 60 MacAdam	Ra	≥ 15000	[h]	15000	Hg	RoHS	A++	CE	ERAC
220-240 AC	50/60			≥ 80								

STEP CCT FUNCTION

WW NW CW
1x CLICK 2x CLICK 3x CLICK



Kanlux XLED łączy w sobie najlepsze cechy tradycyjnych żarówek i nowoczesnych źródeł światła LED. Dlatego mówimy o nim, że to pierwsza prawdziwa „żarówka LED”. Szklana bańka w kształcie tradycyjnej żarówki i diody LED rozmieszczone w taki sposób, że światło rozchodzi się we wszystkich kierunkach. Dodatkowo w wersji CCT możemy zmieniać barwę światła.

Materiał klosza: szkło

Kanlux XLED combines the best features of traditional bulbs and modern LED light sources. Therefore, we talk about it as the first real LED bulb. A glass bulb in the shape of a traditional bulb and LED diodes placed in such a way so that light can part in all directions. Additionally, in the CCT version you can change the colour of light.

Lampshade material: glass

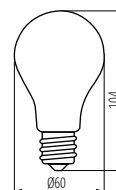

XLED A60 7W-STEP CCT

RAPID LED E27

ŹRÓDŁO ŚWIATŁA LED ► LED LIGHT SOURCE



RAPID LED E27, RAPID PRO LED E27



RAPID LED E27, RAPID PRO LED E27



RAPID MAXX LED E27



RAPID HI LED E27



Źródła Kanlux RAPID E27 są LEDowym odpowiednikami tradycyjnych żarówek. Ich wersje RAPID HI sięgają najwyższych mocy (odpowiedniki 100W). Wyróżniają się przede wszystkim wysokim strumieniem świetlnym i szerokim kątem świecenia. Dodatkowym atutem tych źródeł jest hybrydowa konstrukcja obudowy.

Materiał: tworzywo sztuczne

Kanlux RAPID E27 sources are LED counterparts of traditional bulbs. Their versions RAPID HI reach the highest power (counterparts 100W). They are mainly distinguished by a high light stream and a wide angle of light. Hybrid structure of the casing is an additional asset of these sources.

Materiał: plastic

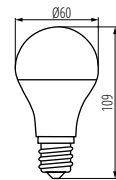

RAPID LED E27, RAPID PRO LED E27

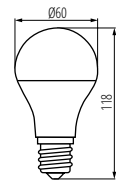

RAPID MAXX LED E27

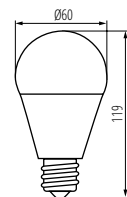

RAPID HI LED E27



	[W]	[PF]	[lm]	[K]	[°]	[h]				
RAPID LED E27-WW	22940	5905339229403	6,5	42	500	3000	200	E27	≥15000	20000
RAPID LED E27-NW	22941	5905339229410	6,5	45	550	4000	200	E27	≥15000	20000
RAPID PRO LED E27-WW	22950	5905339229502	9,5	60	800	3000	200	E27	≥15000	20000
RAPID PRO LED E27-NW	22951	5905339229519	9,5	63	850	4000	200	E27	≥15000	20000
RAPID MAXX LED E27-WW	23282	5905339232823	12	75	1050	3000	180	E27	≥10000	15000
RAPID MAXX LED E27-NW	23283	5905339232830	12	75	1050	4000	180	E27	≥10000	15000
RAPID HI LED E27-WW	25400	5905339254009	15	100	1520	3000	200	E27	≥15000	15000
RAPID HI LED E27-NW	25401	5905339254016	15	100	1520	4000	200	E27	≥15000	15000

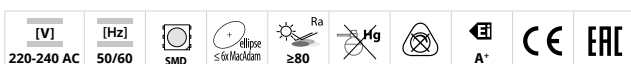

RAPID LED B22

ŹRÓDŁO ŚWIATEŁA LED ► LED LIGHT SOURCE



RAPID PRO LED B22, RAPID MAXX LED B22



RAPID PRO LED B22, RAPID MAXX LED B22



RAPID HI LED B22



Źródła Kanlux RAPID B22 są LEDowymi odpowiednikami tradycyjnych żarówek o tym samym trzonku. Ich wersje RAPID HI sięgają najwyższych mocy (odpowiedniki 100W). Wyróżniają się przede wszystkim wysokim strumieniem świetlnym i szerokim kątem świecenia. Dodatkowym atutem tych źródeł jest hybrydowa konstrukcja obudowy.

Material: tworzywo sztuczne

Kanlux RAPID B22 sources are LED counterparts of traditional bulbs with the same light bulb base. Their versions RAPID HI reach the highest power (counterparts 100W). They are mainly distinguished by a high light stream and a wide angle of light. Hybrid structure of the casing is an additional asset of these sources.

Material: plastic

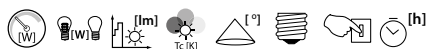

Model	Code	Power (W)	Height (mm)	Width (mm)	Lumen (lm)	Beam Angle (°)	Temp (K)	Base	Life (h)	Life (h)
RAPID PRO LED B22-WW	22952	5905339229526	10	60	800	3000	200	B22	≥15000	20000
RAPID PRO LED B22-CW	22953	5905339229533	10	60	800	6500	200	B22	≥15000	20000
RAPID MAXX LED B22-WW	23284	5905339232847	12	75	1050	3000	180	B22	≥10000	15000
RAPID MAXX LED B22-CW	23285	5905339232854	12	75	1050	6500	180	B22	≥10000	15000
RAPID HI LED B22-WW	25402	5905339254023	15	100	1520	3000	200	B22	≥15000	15000
RAPID HI LED B22-NW	25403	5905339254030	15	100	1520	4000	200	B22	≥15000	15000

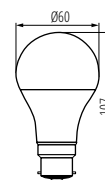

RAPID PRO LED B22, RAPID MAXX LED B22

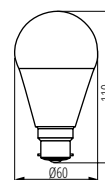

RAPID HI LED B22

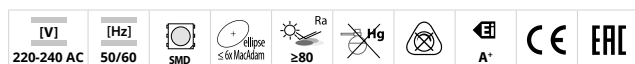

EBRI LED

ŹRÓDŁO ŚWIATŁA LED ► LED LIGHT SOURCE



EBRI LED 17W E27



EBRI LED 17W E27



EBRI LED 21W E27



SUPER HIGH
lumen

IC driver

ALU inside

Kanlux EBRI LED to wysokowydajne źródła o silnych strumieniach świetlnych. Duże rozmiary źródeł przekładają się również na ich duże moce. Kształt źródeł powoduje, że z powodzeniem możemy je zastosować w zwisach takich jak Kanlux TOKIA.

Materiał: tworzywo sztuczne

The Kanlux EBRI LED is a highly efficient source with high luminous fluxes. The large size of the sources also translates into their large capacity. The shape of the source allows you to successfully use it in pendant lamps such as the Kanlux TOKIA.

Materiał: plastic

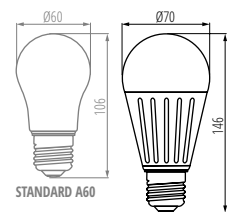

EBRI LED 17W

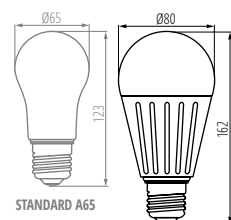

EBRI LED 21W



[V]	[Hz]	[W]	[lm]	[°]	[h]	[Ra]	[h]	[h]	[h]	[h]	[h]	[h]	[h]	[h]	[h]	[h]	[h]	[h]	[h]
220-240 AC	50/60	SMD	≤ 60°	≥ 80	≥ 15000	15000	RoHS	CE	EAC										

Kanlux XLED ST64

ŹRÓDŁO ŚWIATŁA LED ► LED LIGHT SOURCE

NEW



XLED ST64 7W-WW

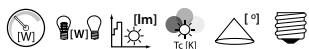

XLED ST64 7W-WW | 29637 | 5905339296375 | 7 | 55 | 725 | 2500 | 320 | E27

[V] 220-240 AC	[Hz] 50/60	FILAMENT	elliptical ≤ 60 MacAdam	Ra ≥ 80	≥ 15000	[h] 15000	Hg		EI A+	CE	ERC
-------------------	---------------	----------	----------------------------	------------	---------	--------------	----	--	----------	----	-----



Kanlux XLED łączy w sobie najlepsze cechy tradycyjnych żarówek i nowoczesnych źródeł światła LED. Dlatego mówimy o nim, że to pierwsza prawdziwa „żarówka LED”. Szklana bańka i diody LED rozmieszczone w taki sposób, że światło rozchodzi się we wszystkich kierunkach. Dodatkowo wersja ST64 wykonana jest ze szkła o złotym zabarwieniu co podkreśla ciepłą barwę światła tego źródła i nadaje mu dodatkowej, szlachetnej elegancji.

Materiał klosza: szkło

Kanlux XLED combines the best features of traditional bulbs and modern LED light sources. Therefore, we talk about it as the first real LED bulb. A glass bulb and LED diodes placed in such a way so that light can part in all directions. Additionally, the ST64 version is made of glass in gold colour, which emphasizes the warm colour of light of this source and gives additional, noble elegance to it.

Lampshade material: glass

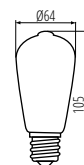

XLED ST64-7W

Kanlux XLED G125

ŹRÓDŁO ŚWIATŁA LED ► LED LIGHT SOURCE

NEW



XLED G125 7W-WW

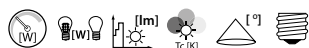

XLED G125 7W-WW | 29638 | 5905339296382 | 7 | 55 | 725 | 2500 | 320 | E27

[V] 220-240 AC	[Hz] 50/60	FILAMENT	elliptical ≤ 60 MacAdam	Ra ≥ 80	≥ 15000	[h] 15000	Hg		EI A+	CE	ERC
-------------------	---------------	----------	----------------------------	------------	---------	--------------	----	--	----------	----	-----



Kanlux XLED to nie tylko najlepsze parametry świetlne, ale również dodatkowa dekoracyjność. Żarówka Kanlux XLED G125 to duża okrągła szklana bańka i szeroki kąt świecenia. Kanlux XLED G125 bardzo przyjemnie prezentują się w otwartych lampach i kinkietach, a także w wiszach bez klosza.

Materiał klosza: szkło

Kanlux XLED does not only mean the best lighting parameters, but also additional decorativeness. Kanlux XLED G125 bulbs are a large round glass bulb and a wide angle of light. Kanlux XLED G125 look very pleasant in open lamps and wall lamps as well as in sags without a shade.

Lampshade material: glass

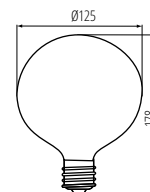

XLED G125 7W

LUNI LED

ŹRÓDŁO ŚWIATŁA LED ► LED LIGHT SOURCE



LUNI PRO E27 LED, LUNI MAX E27 LED



LUNI PRO E27 LED



LUNI MAX E27 LED



Kanlux LUNI LED to duże źródła o dekoracyjnym charakterze. Świetnie prezentują się w dużych, otwartych oprawach lub w zwisach przy których nie stosujemy klosza. Źródła Kanlux LUNI LED mają bardzo wysokie strumienie świetlne, dlatego też mogą pojedynczo oświetlać pomieszczenia.

Material: tworzywo sztuczne

Kanlux LUNI LED are large, decorative sources of light. They look great in large, open luminaires or in hanging lamps in which shade is not used. Kanlux LUNI LED sources have very high light beams, which is why they can illuminate rooms individually.

Material: plastic

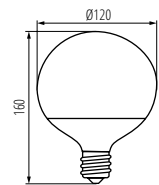

LUNI PRO E27 LED

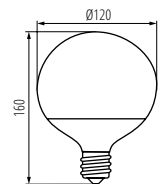

LUNI MAX E27 LED



LUNI PRO E27 LED-WW	22571	5905339225719	16	100	1520	3000	220	E27
LUNI MAX E27 LED-WW	22572	5905339225726	16	115	1800	3000	220	E27

[V]	[Hz]	SMD	Ra	lifetime	Hg	A+	CE	EAC
220-240 AC	50/60		≥80	≥10000	15000			

Kanlux

IQ-LED C37

ŹRÓDŁO ŚWIATŁA LED ► LED LIGHT SOURCE



IQ-LED C37E14 5,5W



IQ-LED C37E14 5,5W



IQ-LED C37E14 7,5W



Kanlux IQ-LED to bezpieczeństwo fotobiologiczne, przyjazna oczom temperatura barwowa i niezawodność, a to wszystko zachowane w klasycznym designie C37. Żarówki IQ-LED zapewniają pełen komfort użytkowania oraz bezpieczeństwo, które potwierdza certyfikat TÜV Rheinland.

Materiał: tworzywo sztuczne

The Kanlux IQ-LED means photobiological safety and eye-friendly colour temperature and reliability, all in the classic C37 design. IQ-LED bulbs provide full comfort of use and safety, which is confirmed by the TÜV Rheinland certificate.

Materiał: plastic

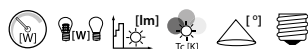

IQ-LED C37E14 5,5W-WW	27294	5905339272942	5,5	40	470	2700	280	E14
IQ-LED C37E14 5,5W-NW	27295	5905339272959	5,5	41	490	4000	280	E14
IQ-LED C37E14 5,5W-CW	27296	5905339272966	5,5	41	490	6500	280	E14
IQ-LED C37E14 7,5W-WW	27297	5905339272973	7,5	60	810	2700	280	E14
IQ-LED C37E14 7,5W-NW	27298	5905339272980	7,5	61	830	4000	280	E14
IQ-LED C37E14 7,5W-CW	27299	5905339272997	7,5	61	830	6500	280	E14

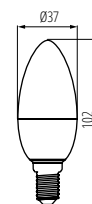

IQ-LED C37E14 5,5W

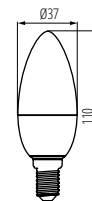

IQ-LED C37E14 7,5W

[V] 220-240 AC	[Hz] 50/60	SMD	ellipse ≤ 60° Nachdäm	Ra ≥ 80	h ≥ 40000	[h] 15000	Hg	RoHS	Ei A+	CE	ERC
--------------------------	----------------------	------------	---------------------------------	-------------------	---------------------	---------------------	-----------	-------------	-----------------	-----------	------------

Kanlux

XLED C35

ŹRÓDŁO ŚWIATŁA LED ► LED LIGHT SOURCE

NEW



XLED C35E14 4,5W



XLED C35E14 2,5W



XLED C35E14 4,5W

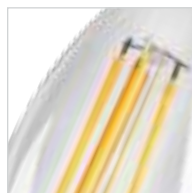

Kanlux XLED łączy w sobie najlepsze cechy tradycyjnych żarówek i nowoczesnych źródeł światła LED. Dlatego mówimy o nim, że to pierwsza prawdziwa „żarówka LED”. Szklana bańka w kształcie tradycyjnej „świeczki” i diody LED rozmieszczone w taki sposób, że światło rozchodzi się we wszystkich kierunkach, a kąt świecenia wynosi nawet 320 stopni!

Materiał klosza: szkło

Kanlux XLED combines the best features of traditional bulbs and modern LED light sources. Therefore, we talk about it as the first real LED bulb. A glass bulb in the shape of a traditional “candle” and LED diodes placed in such a way so that light can part in all directions, and the angle of light comes to even 320 degrees!

Lampshade material: glass



Model	Code	Part No.	Power [W]	Wattage [W]	Light Output [lm]	Beam Angle [°]	Base [E14]
XLED C35E14 2,5W-WW	29617	5905339296177	2,5	25	250	320	E14
XLED C35E14 4,5W-WW	29618	5905339296184	4,5	40	470	320	E14
XLED C35E14 4,5W-NW	29619	5905339296191	4,5	40	470	4000	E14

[V]	[Hz]	FILAMENT	ellipso s/On MacAdam	Ra ≥80	≥15000	15000	Hg	A+	CE	EAC
220-240 AC	50/60							A++		

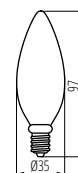

XLED C35E14 2,5W; 4,5W

Kanlux

XLED C35M

ŹRÓDŁO ŚWIATŁA LED ► LED LIGHT SOURCE

NEW



XLED C35M E14 4,5W; 6W



Kanlux XLED łączy w sobie najlepsze cechy tradycyjnych żarówek i nowoczesnych źródeł światła LED. Dlatego mówimy o nim, że to pierwsza prawdziwa „żarówka LED”. Matowa bańka w kształcie tradycyjnej „świeczki” i diody LED rozmieszczone w taki sposób, że światło rozchodzi się we wszystkich kierunkach, a kąt świecenia wynosi nawet 320 stopni!

Material klosza: szkło

Kanlux XLED combines the best features of traditional bulbs and modern LED light sources. Therefore, we talk about it as the first real LED bulb. A mat bulb in the shape of a traditional “candle” and LED diodes placed in such a way so that light can part in all directions, and the angle of light comes to even 320 degrees!

Lampshade material: glass

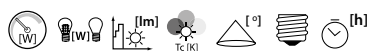

XLED C35E14 4,5W-WW-M	29620	5905339296207	4,5	40	470	2700	320	E14	15000
XLED C35E14 4,5W-NW-M	29621	5905339296214	4,5	40	470	4000	320	E14	15000
XLED C35E14 6W-WW-M	29622	5905339296221	6	60	810	2700	320	E14	10000
XLED C35E14 6W-NW-M	29623	5905339296238	6	60	810	4000	320	E14	10000

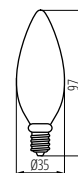

XLED C35M E14 4,5W; 6W

[V] 220-240 AC	[Hz] 50/60	FILAMENT	Ellipse ≤ 600 Modkam	Ra ≥ 80	≥ 15000	Hg	RoHS	CE	ERC
-------------------	---------------	----------	-------------------------	------------	---------	----	------	----	-----

DUN LED

ŹRÓDŁO ŚWIATŁA LED ► LED LIGHT SOURCE



DUN 4,5WT SMD E14



DUN 4,5W T SMD E14



DUN 6,5W T SMD E14



Niewielkich rozmiarów Kanlux DUN to żarówka typu „świeczka” o trzonku E14. Trwałość tych źródeł została uzyskana dzięki połączeniu diod LED SMD i ceramicznej obudowy. Kanlux DUN charakteryzują się dużą wydajnością świetlną. Ddoskonale nadają się do kinkietów i żyrandoli we wszystkich miejscach gdzie pomimo niewielkiego źródła chcemy uzyskać dużo światła.

Materiał: tworzywo sztuczne

The small-size Kanlux DUN is a "candle-type" bulb with E14 screw. Durability of these light sources results from the combination of LED SMD diodes and ceramic housing. Kanlux DUN are characterised by high luminous efficiency. They are perfect for wall lamps and chandeliers in all places where we want to get a lot of light even though its source is small.

Materiał: plastic

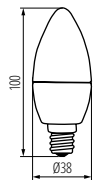

DUN 4,5W T SMD E14

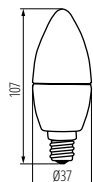

DUN 6,5W T SMD E14

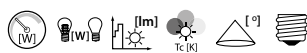

DUN 4,5WT SMD E14-WW	23380	5905339233806	4,5	35	400	3000	230	E14
DUN 4,5WT SMD E14-NW	23381	5905339233813	4,5	35	400	4000	230	E14
DUN 6,5WT SMD E14-WW	23430	5905339234308	6,5	48	600	3000	210	E14
DUN 6,5WT SMD E14-NW	23431	5905339234315	6,5	48	600	4000	210	E14

[V]	[Hz]	SMD	ellipse ≤ 6x MacAdam	Ra	≥80	≥15000	20000	[h]	Hg	RoHS	CE	EAC
220-240 AC	50/60											

Kanlux

DUN HI LED

ŹRÓDŁO ŚWIATŁA LED ► LED LIGHT SOURCE



DUN HI 8W E14



Niewielkich rozmiarów Kanlux DUN HI to żarówka typu „świeczka” o trzonku E14. Trwałość tych źródeł została uzyskana dzięki połączeniu diod LED SMD i ceramicznej obudowy. Kanlux DUN HI charakteryzują się dużą wydajnością świetlną, przy mocy 8W emitują światło o strumieniu 800 lm. Ddoskonale nadają się do kinkietów i żyrandoli we wszystkich miejscach gdzie pomimo niewielkiego źródła światła i małej mocy chcemy uzyskać dużą ilość światła.

Material: ceramika

Material klosza: tworzywo sztuczne

The small-size Kanlux DUN HI is a “candle-type” bulb with E14 screw. Durability of these light sources results from the combination of LED SMD diodes and ceramic housing. Kanlux DUN HI are characterised by high luminous efficiency, at the power of 8W they emit light with a stream of 800 lm. They are perfect for wall lamps and chandeliers in all places where we want a lot of light even though the source is small.

Material: ceramics

Lampshade material: plastic



DUN HI 8W E14-VVV	26760	5905339267603	8	60	800	3000	210	E14
DUN HI 8W E14-NVV	26761	5905339267610	8	60	800	4000	210	E14

[V]	[Hz]	SMD	Ellipse ≤ 600Kcd/m²	Ra	≥ 80	≥ 15000	[h]	17500	Mg	RoHS	EI	CE	ERC
220-240 AC	50/60										A+		

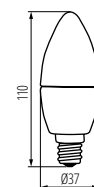

DUN HI 8W E14

IDO LED

ŹRÓDŁO ŚWIATŁA LED ► LED LIGHT SOURCE



IDO 4,5W T SMD E14



IDO 4,5W T SMD E14



IDO 6,5W T SMD E14



Kanlux IDO to źródła w kształcie „świeczki” o trzonku E14. Te LEDowe źródła charakteryzują się dużym kątem świecenia (230°), wyróżnia je również ozdobny kształt.

Materiał: tworzywo sztuczne

Kanlux IDO are candle-shaped sources with a E14 screw. These LED sources are characterised by large illumination angle (230°) and their decorative shape.

Materiał: plastic



IDO 4,5W T SMD E14

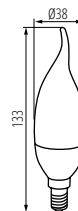

IDO 6,5W T SMD E14

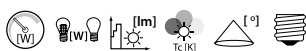

Model	Code	Part No.	Power (W)	Power Factor (PF)	Luminous Flux (lm)	Color Temp (K)	Beam Angle (°)	Base
IDO 4,5W T SMD E14-WW	23382	5905339233820	4,5	35	400	3000	230	E14
IDO 4,5W T SMD E14-NW	23383	5905339233837	4,5	35	400	4000	230	E14
IDO 6,5W T SMD E14-WW	23490	5905339234902	6,5	48	600	3000	210	E14
IDO 6,5W T SMD E14-NW	23491	5905339234919	6,5	48	600	4000	210	E14

[V] 220-240 AC	[Hz] 50/60	SMD	≤ 0,1W/100mm	Ra ≥ 80	Life span ≥ 15000	20000	Hg	RoHS	A*	CE	EAC
-------------------	---------------	-----	--------------	------------	----------------------	-------	----	------	----	----	-----

IQ-LED G45

ŹRÓDŁO ŚWIATŁA LED ► LED LIGHT SOURCE



IQ-LED G45E14 5,5W



IQ-LED G45E27 5,5W



IQ-LED G45E14 7,5W



IQ-LED G45E27 7,5W



Kanlux IQ-LED to bezpieczeństwo fotobiologiczne, przyjazna oczom temperatura barwowa i niezawodność, a to wszystko zachowane w klasycznym designie G45. Żarówki IQ-LED zapewniają pełen komfort użytkowania oraz bezpieczeństwo, które potwierdza certyfikat TÜV Rheinland.

Materiał: tworzywo sztuczne
Materiał klosza: tworzywo sztuczne

The Kanlux IQ-LED means photobiological safety and eye-friendly colour temperature and reliability, all in the classic G45 design. IQ-LED bulbs provide full comfort of use and safety, which is confirmed by the TÜV Rheinland certificate.

Materiał: plastic
Lampshade material: plastic

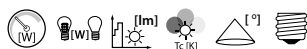

Model	Code	Power [W]	Beam angle [°]	Light flux [lm]	Temp. [K]	Life [h]	Color [Ra]	Class [Ei]
IQ-LED G45E14 5,5W-WW	27300	5,5	40	470	2700	220	E14	
IQ-LED G45E14 5,5W-NW	27301	5,5	41	490	4000	220	E14	
IQ-LED G45E14 5,5W-CW	27302	5,5	41	490	6500	220	E14	
IQ-LED G45E27 5,5W-WW	27303	5,5	40	470	2700	220	E27	
IQ-LED G45E27 5,5W-NW	27304	5,5	41	490	4000	220	E27	
IQ-LED G45E27 5,5W-CW	27305	5,5	41	490	6500	220	E27	
IQ-LED G45E14 7,5W-WW	27306	7,5	60	810	2700	200	E14	
IQ-LED G45E14 7,5W-NW	27307	7,5	61	830	4000	200	E14	
IQ-LED G45E14 7,5W-CW	27308	7,5	61	830	6500	200	E14	
IQ-LED G45E27 7,5W-WW	27309	7,5	60	810	2700	200	E27	
IQ-LED G45E27 7,5W-NW	27310	7,5	61	830	4000	200	E27	
IQ-LED G45E27 7,5W-CW	27311	7,5	61	830	6500	200	E27	

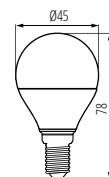

IQ-LED G45E14 5,5W

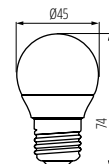

IQ-LED G45E27 5,5W

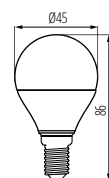

IQ-LED G45E14 7,5W

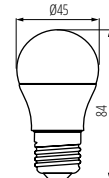

IQ-LED G45E27 7,5W



Kanlux

XLED G45

ŹRÓDŁO ŚWIATŁA LED ► LED LIGHT SOURCE

NEW



XLED G45 E14 4,5W



XLED G45 E14 4,5W



XLED G45 E27 4,5W

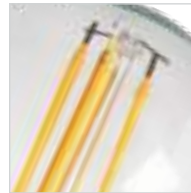

Kanlux XLED łączy w sobie najlepsze cechy tradycyjnych żarówek i nowoczesnych źródeł światła LED. Dlatego mówimy o nim, że to pierwsza prawdziwa „żarówka LED”. Szklana bańka w kształcie tradycyjnej „kulki” i diody LED rozmieszczone w taki sposób, że światło rozchodzi się we wszystkich kierunkach. Do wyboru mamy źródła z trzonkiem E27 i E14.

Materiał klosza: szkło

Kanlux XLED combines the best features of traditional bulbs and modern LED light sources. Therefore, we talk about it as the first real LED bulb. A glass bulb in the shape of a traditional “ball” and LED diodes placed in such a way so that light can part in all directions. You choose from sources with E27 and E14 light bulb bases.

Lampshade material: glass

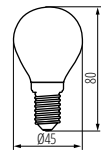

XLED G45 E14 4,5W

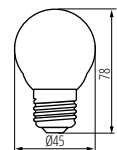

XLED G45 E27 4,5W

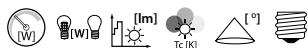

XLED G45 E14 4,5W-WW	29624	5905339296245	4,5	40	470	2700	320	E14
XLED G45 E27 4,5W-WW	29625	5905339296252	4,5	40	470	2700	320	E27

[V]	[Hz]	FILAMENT	Ra	≥80	≥15000	15000	Hg	⊗	CE	EAC
220-240 AC	50/60									

Kanlux

XLED G45M

ŹRÓDŁO ŚWIATŁA LED ► LED LIGHT SOURCE

NEW



XLED G45M E14 4,5W; 6W



XLED G45M E14 4,5W; 6W



XLED G45M E27 4,5W; 6W



Kanlux XLED łączy w sobie najlepsze cechy tradycyjnych żarówek i nowoczesnych źródeł światła LED. Dlatego mówimy o nim, że to pierwsza prawdziwa „żarówka LED”. Matowa bańka w kształcie tradycyjnej „kulki” i diody LED rozmieszczone w taki sposób, że światło rozchodzi się we wszystkich kierunkach. Do wyboru mamy źródła z trzonkiem E27 i E14.

Material klosza: szkło

Kanlux XLED combines the best features of traditional bulbs and modern LED light sources. Therefore, we talk about it as the first real LED bulb. A mat bulb in the shape of a traditional “ball” and LED diodes placed in such a way so that light can part in all directions. You choose from sources with E27 and E14 light bulb bases.

Lampshade material: glass



XLED G45E14 4,5W-WW-M	29626	5905339296269	4,5	40	470	2700	320	E14	15000
XLED G45E14 4,5W-NW-M	29627	5905339296276	4,5	40	470	4000	320	E14	15000
XLED G45 E14 6W-WW-M	29628	5905339296283	6	60	810	2700	320	E14	10000
XLED G45 E14 6W-NW-M	29629	5905339296290	6	60	810	4000	320	E14	10000
XLED G45E27 4,5W-WW-M	29630	5905339296306	4,5	40	470	2700	320	E27	15000
XLED G45E27 4,5W-NW-M	29631	5905339296313	4,5	40	470	4000	320	E27	15000
XLED G45 E27 6W-WW-M	29632	5905339296320	6	60	810	2700	320	E27	10000
XLED G45 E27 6W-NW-M	29633	5905339296337	6	60	810	4000	320	E27	10000

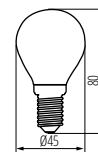

XLED G45M E14 4,5W; 6W

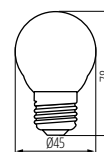

XLED G45M E27 4,5W; 6W



BILO LED

ŹRÓDŁO ŚWIATŁA LED ► LED LIGHT SOURCE

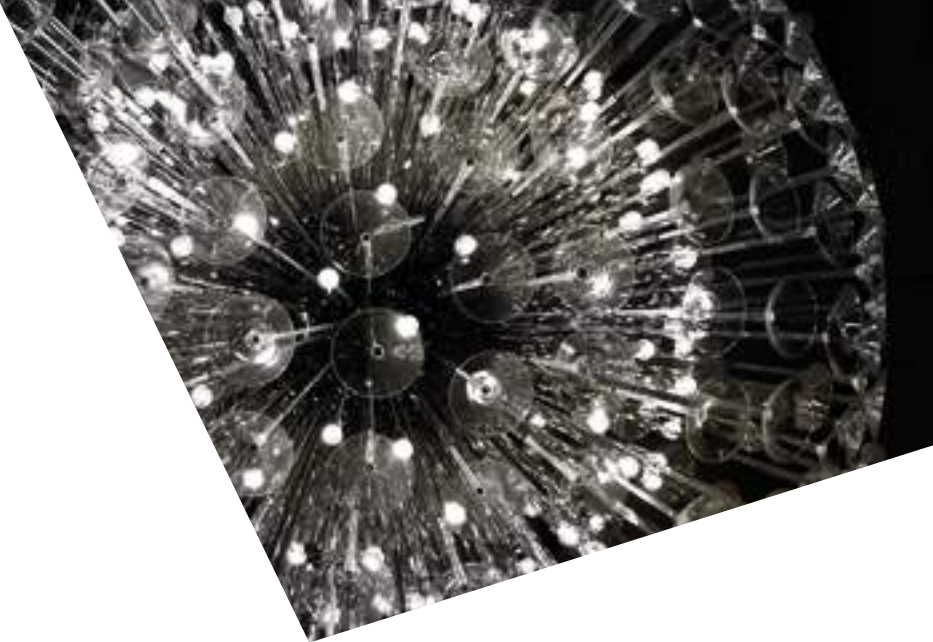

BILO 3W; 5W T SMD E14



BILO 3W; 5W T SMD E14



BILO 3W; 5W T SMD E27



BILO 6,5W T SMD E27



Kanlux BILO to trwałość, która została uzyskana dzięki innowacyjnej technologii LED SMD oraz ceramicznej obudowie. Wszystkie modele Kanlux BILO charakteryzują się dużą wydajnością świetlną. Te źródła o trzonku E14 i kształcie „kulki” źródła doskonale nadają się do kinkietów i żyrandoli we wszystkich miejscach, gdzie znaczenie ma estetyka i duża ilość światła.

Materiał klosza: tworzywo sztuczne

Kanlux BILO ensures durability which was obtained thanks to innovative LED SMD technology and ceramic housing. All Kanlux BILO models are characterised by high luminous efficiency. These sources with E14 screw and “ball” shape are perfect for sconces and chandeliers in all places where aesthetics and large amounts of light are important.

Lampshade material: plastic



	[W]	[lm]	[°]	[h]					
BILO 3WT SMD E14-WW	23040	5905339230409	3	27	280	3000	200	E14	25000
BILO 3WT SMD E27-WW	23041	5905339230416	3	27	280	3000	200	E27	25000
BILO 5WT SMD E14-WW	23042	5905339230423	5	37	420	3000	200	E14	25000
BILO 5WT SMD E27-WW	23043	5905339230430	5	37	420	3000	200	E27	25000
BILO 6,5WT SMDE27-WW	23420	5905339234209	6,5	48	600	3000	200	E27	20000
BILO 6,5WT SMDE27-NW	23421	5905339234216	6,5	48	600	4000	200	E27	20000
BILO 6,5WT SMDE14-WW	23422	5905339234223	6,5	48	600	3000	200	E14	20000
BILO 6,5WT SMDE14-NW	23423	5905339234230	6,5	48	600	4000	200	E14	20000

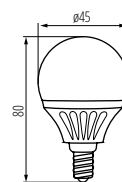

BILO 3W; 5W T SMD E14

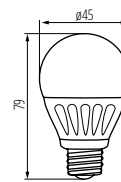

BILO 3W; 5W T SMD E27

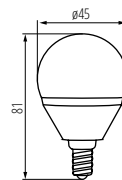

BILO 6,5W T SMD E14

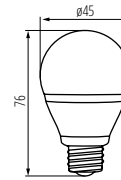

BILO 6,5W T SMD E27

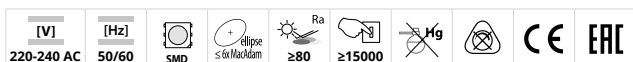

BILO HI LED

ŹRÓDŁO ŚWIATŁA LED ► LED LIGHT SOURCE



BILO HI 8W E14



BILO HI 8W E14



BILO HI 8W E27



Kanlux BILO HI to trwałość, która została uzyskana dzięki innowacyjnej technologii LED SMD oraz ceramicznej obudowie. Wszystkie modele Kanlux BILO HI charakteryzują się dużą wydajnością świetlną, gdyż przy poborze mocy 8W emitują światło o strumieniu 800 lm. Te źródła o trzonku E14 i kształcie „kulki” źródła doskonale nadają się do kinkietów i żyrandoli we wszystkich miejscach, gdzie znaczenie ma estetyka i duża ilość światła przy niewielkiej mocy.

Materiał: ceramika

Materiał klosza: tworzywo sztuczne

Kanlux BILO HI ensures durability which was obtained thanks to innovative LED SMD technology and ceramic housing. All Kanlux BILO HI models are characterised by high luminous efficiency since they emit light of 800 lm beam at 8W power consumption. These sources with E14 screw and “ball” shape are perfect for sconces and chandeliers in all places where aesthetics and large amounts of light at low power are important.

Materiał: ceramika

Lampshade material: plastic

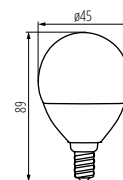

BILO HI 8W E14

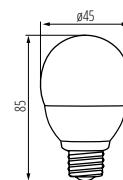

BILO HI 8W E27

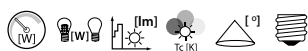

Model	Code	Part No.	Power [W]	Beam Angle [°]	Luminous Flux [lm]	Life [h]	Temp. [°C]	Base
BILO HI 8W E14-VVV	26762	5905339267627	8	60	800	3000	210	E14
BILO HI 8W E14-NW	26763	5905339267634	8	60	800	4000	210	E14
BILO HI 8W E27-VVV	26764	5905339267641	8	60	800	3000	210	E27
BILO HI 8W E27-NW	26765	5905339267658	8	60	800	4000	210	E27

[VI]	[Hz]	SMD	≤600mcd/m²	Ra ≥80	≥15000	17500	Hg	RoHS	CE	ERC
220-240 AC	50/60									

Kanlux

IQ-LED GU10

ŹRÓDŁO ŚWIATŁA LED ► LED LIGHT SOURCE

NEW



IQ-LED GU10 5W



IQ-LED GU10 5W



IQ-LED GU10 7W



Safety
Regular
Production
Surveillance

www.tuv.com
ID: 0000055711



Kanlux IQ-LED to bezpieczeństwo fotobiologiczne, przyjazna oczom temperatura barwowa i niezawodność. Teraz to wszystko w nowej wersji z trzonkiem GU10. Żarówki IQ-LED zapewniają pełen komfort użytkowania oraz bezpieczeństwo, które potwierdza certyfikat TÜV Rheinland.

Materiał klosza: tworzywo sztuczne



Kanlux IQ-LED means photo-biological safety, colour temperature friendly to eyes and reliability. Now, all this in a new version with GU10 light bulb base. IQ-LED bulbs ensure full comfort of use and safety, which is confirmed by TÜV Rheinland certificate.

Lampshade material: plastic



Model	Code	Part No.	W	W	lm	lm/W	K	°	Base
IQ-LED GU10 5W-WW	29803	5905339298034	5	31	370	335	2700	120	GU10
IQ-LED GU10 5W-NW	29804	5905339298041	5	31	380	340	4000	120	GU10
IQ-LED GU10 5W-CW	29805	5905339298058	5	31	380	340	6500	120	GU10
IQ-LED GU10 7W-S3-WW	29806	5905339298065	7	75	580	535	2700	36	GU10
IQ-LED GU10 7W-S3-NW	29807	5905339298072	7	75	580	535	4000	36	GU10
IQ-LED GU10 7W-S3-CW	29808	5905339298089	7	75	580	535	6500	36	GU10
IQ-LED GU10 7W-WW	29809	5905339298096	7	43	580	520	2700	120	GU10
IQ-LED GU10 7W-NW	29810	5905339298102	7	43	580	520	4000	120	GU10
IQ-LED GU10 7W-CW	29811	5905339298119	7	43	580	520	6500	120	GU10

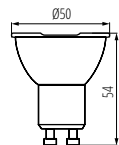

IQ-LED GU10 5W

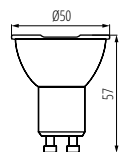

IQ-LED GU10 7W

[V]	[Hz]	SMD	≤ 600Klm	Ra ≥ 95	≥ 40000	25000	Hg	RoHS	A+	CE	EAC
-----	------	-----	----------	---------	---------	-------	----	------	----	----	-----

Kanlux

IQ-LEDIM GU10

ŹRÓDŁO ŚWIATŁA LED ► LED LIGHT SOURCE

NEW



IQ-LEDIM GU10 7,5W



Kanlux IQ-LED to bezpieczeństwo fotobiologiczne, przyjazna oczom temperatura barwowa i niezawodność. Teraz to wszystko w nowej wersji z trzonkiem GU10 - dodatkowo wersja IQ-LEDIM współpracuje ze ściemniaczami. Żarówki IQ-LED zapewniają pełen komfort użytkowania oraz bezpieczeństwo, które potwierdza certyfikat TÜV Rheinland

Materiał klosza: tworzywo sztuczne

Kanlux IQ-LED means photo-biological safety, colour temperature friendly to eyes and reliability. Now, all this in a new version with GU10 light bulb base - additionally, the IQ-LEDIM version cooperates with dimmers. IQ-LED bulbs ensure full comfort of use and safety, which is confirmed by TÜV Rheinland certificate

Lampshade material: plastic



IQ-LEDIM GU10 7,5W-WW	29812	5905339298126	7,5	42	570	510	2700	120	GU10
IQ-LEDIM GU10 7,5W-NW	29813	5905339298133	7,5	42	570	510	4000	120	GU10
IQ-LEDIM GU10 7,5W-CW	29814	5905339298140	7,5	42	570	510	6500	120	GU10

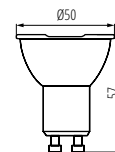
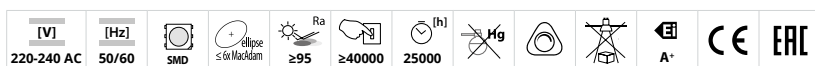

IQ-LEDIM GU10 7,5W

Kanlux

REMI LED

ŹRÓDŁO ŚWIATŁA LED ► LED LIGHT SOURCE



REMI GU10 SMD

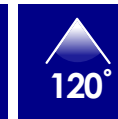

LEDowe źródła światła Kanlux REMI LED przeznaczone są do opraw oświetleniowych o niewielkich rozmiarach. Ich kąt świecenia to 120°. Żarówka ta wyróżnia się małym kształtem, dlatego świetnie sprawdzi się w zgrabnych, małych lampach.

Materiał klosza: szkło

LED light sources Kanlux REMI LED are designed for small-size luminaires. Their illumination angle is 120°. The bulb is distinguished by its small size so it will be useful for neat, small lamps.

Lampshade material: glass



REMI GU10 SMD-WW	14946	5907540962650	2,2	19	180	150	3000	120	GU10
REMI GU10 SMD-CW	14947	5907540963466	2,2	21	200	165	6500	120	GU10

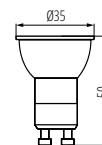
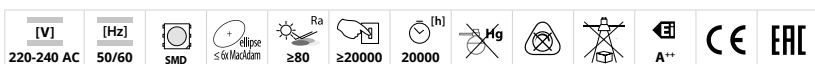

REMI GU10 SMD



FULLED GU10-3,3W



Cechą wyróżniającą Kanlux FULLED jest wygląd zbliżony do tradycyjnych, szklanych halogenów, uzyskany dzięki przezroczystej obudowie z tworzywa. Zastosowanie specjalnej soczewki zapewnia również efekt świecenia zbliżony do tradycyjnego halogenu. Dodatkową zaletą tych lamp jest ich kąt świecenia wynoszący 120 umożliwiający szerokokątne oświetlenie wybranej powierzchni.

Material klosza: tworzywo sztuczne

The appearance similar to the traditional glass halogens, obtained owing to the transparent plastic housing, is the distinguishing feature of Kanlux FULLED. The use of special lens also ensures a lighting effect similar to traditional halogen. Another advantage of these lamps is their illumination angle of 120 allowing for a wide-angle illumination of the selected surface.

Lampshade material: plastic



	[V]	[Hz]	[W]	[lm]	[lm]	[lm]	[lm]	[°]	
FULLED GU10-3,3W-WW	26033	5905339260338	3,3	27	275	235	2700	120	GU10
FULLED GU10-3,3W-NW	26034	5905339260345	3,3	27	285	240	4000	120	GU10
FULLED GU10-3,3W-CW	26035	5905339260352	3,3	28	295	250	6500	120	GU10

[V]	[Hz]	SMD	Flippse ≤ 6x Nachdam	Ra	≥ 80	≥ 15000	15000	Hg			A++	CE	EAC
-----	------	-----	-------------------------	----	------	---------	-------	----	--	--	-----	----	-----

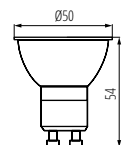

FULLED GU10-3,3W

TEZI LED

ŹRÓDŁO ŚWIATŁA LED ► LED LIGHT SOURCE



TEZI LED3,5W GU10



TEZI LED4,5W GU10



TEZI LED6W GU10



Seria Kanlux TEZI LED to zaawansowana konstrukcja zamknięta w białej obudowie. Duży wybór pozwala na dobór tego źródła do każdego pomieszczenia gdzie mamy lampy z trzonkiem GU10. Kanlux TEZI LED wyposażony jest w stabilizowany zasilacz IC driver, który zapewnia zminimalizowanie efektu migotania, dzięki czemu nie męczy oczu.

Materiał: tworzywo sztuczne

Materiał klosza: tworzywo sztuczne

The Kanlux TEZI LED series is an advanced construction enclosed in a white casing. The wide selection allows you to use this bulb in every room where there are lamps with a GU10 cap. The Kanlux TEZI LED is fitted with a stabilised IC-driver power supply, which ensures no flickering, so does not cause eye fatigue.

Materiał: plastic

Lampshade material: plastic



TEZI LED3,5W GU10-WW	27770	5905339277701	3,5	25	250	220	3000	120	GU10
TEZI LED3,5W GU10-NW	27771	5905339277718	3,5	26	270	240	4000	120	GU10
TEZI LED3,5W GU10-CW	27772	5905339277725	3,5	26	270	240	6500	120	GU10
TEZI LED4,5W GU10-WW	27773	5905339277732	4,5	33	370	320	3000	120	GU10
TEZI LED4,5W GU10-NW	27774	5905339277749	4,5	35	390	340	4000	120	GU10
TEZI LED4,5W GU10-CW	27775	5905339277756	4,5	35	390	340	6500	120	GU10
TEZI LED6W GU10-WW	27776	5905339277763	6	40	470	420	3000	120	GU10
TEZI LED6W GU10-NW	27777	5905339277770	6	42	500	450	4000	120	GU10
TEZI LED6W GU10-CW	27778	5905339277787	6	42	500	450	6500	120	GU10

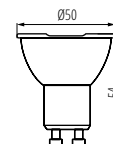

TEZI LED3,5W GU10, TEZI LED4,5W GU10, TEZI LED6W GU10

[VI]	[Hz]	SMD	RoHS	Ra	Life	Hg	RoHS	CE	EAC
220-240 AC	50/60		≤ 0,1	≥ 80	15000			A+	

TOMI LED

ŹRÓDŁO ŚWIATŁA LED ► LED LIGHT SOURCE



TOMI LED 1,2W; 7W GU10



W źródłach Kanlux TOMI LED zastosowano hybrydową konstrukcję radiatora, dzięki czemu wymiana ciepła z otoczeniem jest dużo efektywniejsza. Ponadto biały kolor obudowy Kanlux TOMI LED sprawia, że to źródło jest ciekawe wzorniczo. Światło w tych źródłach jest równomiernie rozprowadzane przez zastosowanie matowego klosza.

Materiał klosza: tworzywo sztuczne

Kanlux TOMI LED sources use hybrid heat sink construction thanks to which heat exchange with the environment is much more effective. Moreover, white colour of Kanlux TOMI LED housing makes the source's design interesting. The light in these sources is evenly distributed by the use of matt shade.

Lampshade material: plastic



TOMI LED 1,2W; 7W GU10



TOMI LED 3W; 5W GU10



	[W]	[V]	[Hz]	[lm]	[lm]	[lm]	[°]	[h]	[h]	EI		
TOMI LED1,2W GU10-CW	22709	5905339227096	1,2	10	90	80	5300	120	GU10	≥25000	25000	A++
TOMI LED1,2W GU10-NW	22822	5905339228222	1,2	10	90	80	4000	120	GU10	≥25000	25000	A++
TOMI LED1,2W GU10-WW	22708	5905339227089	1,2	10	90	80	3000	120	GU10	≥25000	25000	A++
TOMI LED3W GU10-CW	22703	5905339227034	3	26	270	220	5300	120	GU10	≥15000	20000	A++
TOMI LED3W GU10-NW	22823	5905339228239	3	26	260	210	4000	120	GU10	≥15000	20000	A++
TOMI LED3W GU10-WW	22702	5905339227027	3	25	250	200	3000	120	GU10	≥15000	20000	A++
TOMI LED5W GU10-CW	22701	5905339227010	5	34	380	300	5300	120	GU10	≥15000	20000	A+
TOMI LED5W GU10-NW	22824	5905339228246	5	33	370	300	4000	120	GU10	≥15000	20000	A+
TOMI LED5W GU10-WW	22700	5905339227003	5	33	360	290	3000	120	GU10	≥15000	20000	A+
TOMI LED7W GU10-CW	22820	5905339228208	7	43	520	410	5300	120	GU10	≥15000	20000	A+
TOMI LED7W GU10-NW	22825	5905339228253	7	42	510	410	4000	120	GU10	≥15000	20000	A+
TOMI LED7W GU10-WW	22821	5905339228215	7	42	500	400	3000	120	GU10	≥15000	20000	A+

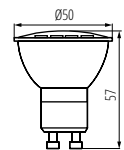

TOMI LED 1,2W; 7W GU10

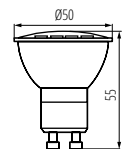

TOMI LED 3W; 5W GU10

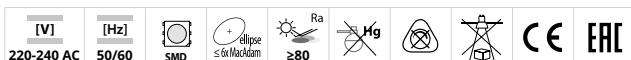

Kanlux

PRO GU10 LED

ŹRÓDŁO ŚWIATŁA LED ► LED LIGHT SOURCE



PRO GU10 LED 7W



Kanlux PRO GU10 LED to źródła światła, które łączą nowoczesne technologie produkcyjne i atrakcyjny wygląd. Serię tę charakteryzuje unikalna budowa z najwyższej jakości komponentów, dzięki którym zyskujemy energooszczędność, przy zachowaniu wysokich parametrów świetlnych. Diody zastosowane w Kanlux PRO GU10 LED to wysoka trwałość wynosząca 25.000h. Linia Kanlux PRO GU10 LED dodatkowo posiada rozbudowaną ofertę produktów o różnych kątach świecenia; 120, 60 bądź 36°. Co umożliwi dobór punktowego lub szerokokątnego doświetlenia wybranej powierzchni.

Materiał klosza: tworzywo sztuczne

Kanlux PRO GU10 LED are light sources that combine modern production technologies and attractive appearance. This series is characterised by unique construction made of the highest quality components owing to which we gain energy efficiency while maintaining high lighting parameters. The diodes used in Kanlux PRO GU10 LED are of high durability equal to 25,000 h. Moreover, Kanlux PRO GU10 LED line has a wide range of products with various illumination angles; 120, 60 or 36°. This allows for selection of spot or wide-angle additional lighting of the selected surface.

Lampshade material: plastic



PRO GU10 LED 7W-W



PRO GU10 LED 7WS3



PRO GU10 LED 7WS6

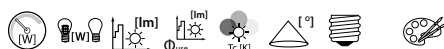

PRO GU10 LED 7W-WW-W	24500	5905339245007	7	44	530	465	2700	120	GU10	biały white
PRO GU10 LED 7W-NW-W	24501	5905339245014	7	45	550	470	4000	120	GU10	biały white
PRO GU10 LED 7W-CW-W	24502	5905339245021	7	46	570	490	6500	120	GU10	biały white
PRO GU10 LED 7W-WW	24503	5905339245038	7	44	530	465	2700	120	GU10	srebrny silver
PRO GU10 LED 7W-NW	24504	5905339245045	7	45	550	470	4000	120	GU10	srebrny silver
PRO GU10 LED 7W-CW	24505	5905339245052	7	46	570	490	6500	120	GU10	srebrny silver
PRO GU10 LED 7WS3-WW	24670	5905339246707	7	45	560	500	2700	36	GU10	srebrny silver
PRO GU10 LED 7WS3-NW	24671	5905339246714	7	47	580	520	4000	36	GU10	srebrny silver
PRO GU10 LED 7WS3-CW	24672	5905339246721	7	48	600	550	6500	36	GU10	srebrny silver
PRO GU10 LED 7WS6-WW	24673	5905339246738	7	45	560	470	2700	60	GU10	srebrny silver
PRO GU10 LED 7WS6-NW	24674	5905339246745	7	47	580	490	4000	60	GU10	srebrny silver
PRO GU10 LED 7WS6-CW	24675	5905339246752	7	48	600	500	6500	60	GU10	srebrny silver

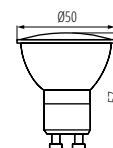

PRO GU10 LED 7W; 7WS3; 7WS6

[V]	[Hz]	SMD	ellipse ≤ 60 MacAdam	Ra	≥ 80	≥ 15000	25000	Hg	RoHS	A+	CE	EAC
-----	------	-----	-------------------------	----	------	---------	-------	----	------	----	----	-----

PRODIM LED

ŹRÓDŁO ŚWIATŁA LED ► LED LIGHT SOURCE



PRODIM GU10 7,5W



PRODIM GU10 7,5W



PRODIM GU10 7,5WS6

Kanlux PRODIM LED to źródła światła, które łączą nowoczesne technologie produkcyjne i atrakcyjny wygląd. Serię tę charakteryzuje unikalna budowa z najwyższej jakości komponentów, dzięki którym zyskujemy energooszczędność, przy zachowaniu wysokich parametrów świetlnych. Diody zastosowane w Kanlux Kanlux PRODIM to wysoka trwałość wynosząca 25.000 h. Kanlux PRODIM to model źródła z możliwością regulacji strumienia świetlnego, współpracujący z dostępnymi na rynku ściemniaczami. Dzięki temu możemy sterować natężeniem oświetlenia dostosowując je do własnych potrzeb.

Materiał klosza: tworzywo sztuczne

Kanlux PRODIM LED are light sources that combine modern production technologies and attractive appearance. This series is characterised by unique construction made of the highest quality components owing to which we gain energy efficiency while maintaining high lighting parameters. The diodes used in Kanlux PRODIM are of high durability equal to 25,000 h. Kanlux PRODIM is a source model allowing for adjusting the luminous flux, compatible with commercially available dimmers. Owing to this, we can regulate the light intensity, adapting it to our own needs.

Lampshade material: plastic

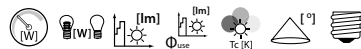

Model	Code	Part No.	Wattage	Beam Angle	Height	Width	Depth	Mounting
PRODIM GU10-7,5W-WW	24660	5905339246608	7,5	44	530	455	2700	120 GU10
PRODIM GU10-7,5W-NW	24661	5905339246615	7,5	45	550	470	4000	120 GU10
PRODIM GU10-7,5W-CW	24662	5905339246622	7,5	45	560	480	6500	120 GU10
PRODIM GU10-7,5WS6-WW	24663	5905339246639	7,5	45	560	450	2700	60 GU10
PRODIM GU10-7,5WS6-NW	24664	5905339246646	7,5	47	580	480	4000	60 GU10
PRODIM GU10-7,5WS6-CW	24665	5905339246653	7,5	48	600	490	6500	60 GU10

[V]	[Hz]	SMD	elliptical	Ra	≥80	≥15000	25000	Hg	⊘	A*	CE	EAC
-----	------	-----	------------	----	-----	--------	-------	----	---	----	----	-----

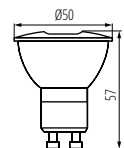

PRODIM GU10 7,5W

Kanlux

TEDI MAXX LED

ŹRÓDŁO ŚWIATŁA LED ► LED LIGHT SOURCE



TEDI MAXX LED GU10



TEDI MAXX LED GU10-WW	23412	5905339234124	9	66	900	710	3000	120	GU10
TEDI MAXX LED GU10-CW	23413	5905339234131	9	66	900	710	6000	120	GU10
TEDI MAXX LED GU10-NW	23414	5905339234148	9	66	900	710	4000	120	GU10

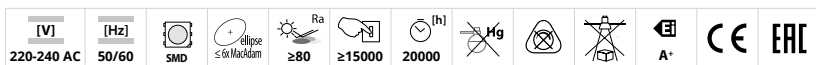

Kanlux TEDI MAXX LED to moc zamknięta w niewielkim korpusie. Wydajne diody LED oraz ceramiczna obudowa to tylko niektóre atuty tych źródeł. Stabilizowany zasilacz zapewnia zminimalizowanie efektu migotania, który mógłby męczyć wzrok. Ponadto Kanlux TEDI MAXX to wydajność świetlna 100lm z Wata, a zastosowana matowa szafka zapewnia równomierny rozsył światła.

Materiał: ceramika
Materiał klosza: tworzywo sztuczne

The Kanlux TEDI MAXX is power enclosed in a small body. Efficient LED's and ceramic casing are just two of the advantages of this light source. The stabilised power supply minimises the flicker effect, which could cause eye fatigue. In addition, The Kanlux TEDI MAXX has a light output of 100lm per 1 Watt, and the matte glass used ensures uniform light distribution

Materiał: ceramics
Lampshade material: plastic

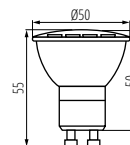

TEDI MAXX LED GU10

Kanlux

LED15 C

ŹRÓDŁO ŚWIATŁA LED ► LED LIGHT SOURCE



LED15 C MR16



LED15 C MR16-WW-B	22203	5905339222039	4,5	34	380	315	3000	120	Gx5,3
LED15 C MR16-CW-B	22204	5905339222046	4,5	35	390	325	6500	120	Gx5,3

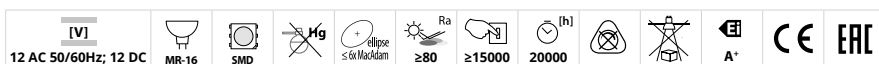

Kanlux LED15 C to źródło światła z trzonkiem MR16. Źródła te charakteryzują się wysoką trwałością, która wynosi 20.000 godzin. Bezpośredni wpływ na wydłużenie ich żywotności ma także ich ceramiczna obudowa, która bardzo dobrze odprowadza ciepło generowane przez diody.

Materiał: ceramika
Materiał klosza: szkło

Kanlux LED15 C is a source of light with MR16 screw cap. These sources are characterised by high durability amounting to 20,000 hours. Their ceramic housing that very well dissipates the heat generated by the diodes also has a direct impact on extending their life.

Materiał: ceramics
Lampshade material: glass

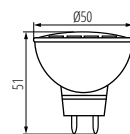

LED15 C MR16

TOMI LED

ŹRÓDŁO ŚWIATŁA LED ► LED LIGHT SOURCE



TOMI LED 5W MR16



TOMI LED 5W MR16



TOMI LED 7W MR16



Kanlux TOMI LED to trwałe źródło LED typu MR16 o klasycznym wyglądzie. W źródłach Kanlux TOMI LED zastosowano hybrydową konstrukcję radiatora (warstwa termotworzywa + aluminiowy wkład), dzięki czemu wymiana ciepła z otoczeniem jest dużo efektywniejsza, a trwałość źródła wynosi 25,000h. Matowa szybka równomiernie rozprasza światło, którego kąt padania wynosi 120°.

Materiał: ceramika

Materiał klosza: tworzywo sztuczne

Kanlux TOMI LED are MR16 type solid LED sources of classic look. Kanlux TOMI LED sources use hybrid heat sink construction thanks to which heat exchange with the environment is much more effective. The matt glass evenly diffuses the light with its illumination angle amounting to 120°.

Materiał: ceramics

Lampshade material: plastic

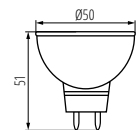

TOMI LED 5W MR16

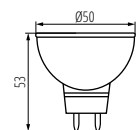

TOMI LED 7W MR16



TOMI LED5W MR16-WW	22704	5905339227041	5	33	370	300	3000	120	Gx5,3			
TOMI LED5W MR16-CW	22705	5905339227058	5	35	390	310	5300	120	Gx5,3			
TOMI LED7W MR16-WW	22706	5905339227065	7	41	480	385	3000	120	Gx5,3			
TOMI LED7W MR16-CW	22707	5905339227072	7	42	500	400	5300	120	Gx5,3			

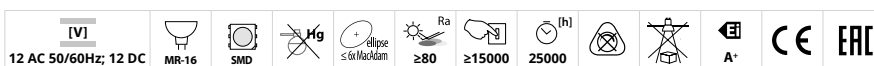

SIGO LED

ŹRÓDŁO ŚWIATEŁA LED ► LED LIGHT SOURCE



SIGO R39 LED E14



SIGO R39 LED E14



SIGO R50 LED E14



SIGO R63 LED E27



Kanlux SIGO LED to nie tylko oszczędność energii, ale też trwałość 15-krotnie wyższa niż w tradycyjnych żarówkach reflektorowych. Ponieważ ich kształt i rozmiar przypomina standardowe żarówki reflektorowe, łatwo je wymienić bez konieczności żadnych dodatkowych modyfikacji.

Materiał klosza: tworzywo sztuczne

Kanlux SIGO LED is both energy-efficient and 15 times more durable than traditional reflector bulbs. Since their shape and size resembles standard reflector bulbs, they are easily replaceable without additional modifications.

Lampshade material: plastic

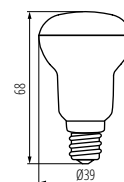

SIGO R39 LED E14

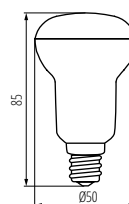

SIGO R50 LED E14

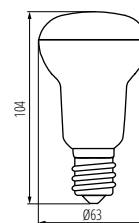

SIGO R63 LED E27



SIGO R39 LED E14-WW	22733	5905339227331	4	30	320	3000	120	E14
SIGO R39 LED E14-NW	22734	5905339227348	4	30	320	4000	120	E14
SIGO R50 LED E14-WW	22735	5905339227355	6	41	480	3000	120	E14
SIGO R50 LED E14-NW	22736	5905339227362	6	41	480	4000	120	E14
SIGO R63 LED E27-WW	22737	5905339227379	8	50	640	3000	120	E27
SIGO R63 LED E27-NW	22738	5905339227386	8	50	640	4000	120	E27

[V]	[Hz]	SMD	ellipso sól MacAdam	Ra	≥80	≥15000	15000	[lm]	15000	Hg	RoHS	CE	ENEC	A+
220-240 AC	50/60													

Kanlux

GIO LED G9

ŹRÓDŁO ŚWIATŁA LED ► LED LIGHT SOURCE



GIO LED G9

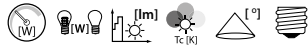

GIO LED G9-WW	22660	5905339226600	2,5	21	200	3000	290	G9
GIO LED G9-NW	22661	5905339226617	2,5	21	200	5000	290	G9

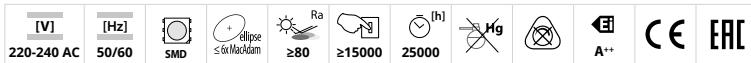

Kanlux GIO LED G9 to małe źródło o kącie świecenia 290°. Wysokowydajne źródła o trzonku G9 mają również bardzo długą żywotność, która wynosi 25.000 godzin.

Materiał: tworzywo sztuczne

Kanlux GIO LED G9 are small sources with illumination angle of 290°. These highly effective sources with G9 screw are also very durable - their lifetime equals to 25,000 hours.

Materiał: plastic

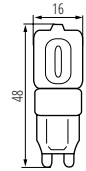

GIO LED G9

Kanlux

G9 GLASS

ŹRÓDŁO ŚWIATŁA LED ► LED LIGHT SOURCE



G9 GLASS LED2W

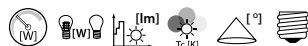

G9 GLASS LED2W-WW	26630	5905339266309	2	21	200	3000	320	G9
G9 GLASS LED2W-CW	26631	5905339266316	2	21	200	6000	320	G9



Kanlux G9 GLASS LED2 dzięki szklanej bańce do złudzenia przypominają tradycyjne źródła. Konstrukcja źródeł Kanlux G9 GLASS gwarantuje szeroki kąt emisji światła i dzięki temu idealnie nadaje się do zastosowania we wszelkich otwartych oprawach i żyrandolach.

Materiał: szkło

Owing to the glass bubble, Kanlux G9 GLASS LED2 are strikingly similar to traditional sources. The construction of Kanlux G9 GLASS sources guarantees a wide light emission angle, owing to which they are perfect for all open luminaires and chandeliers.

Materiał: glass

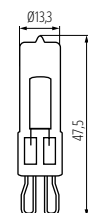

G9 GLASS LED2W

ZUBI LED

ŹRÓDŁO ŚWIATŁA LED ► LED LIGHT SOURCE



ZUBI LED 3,5W G9



ZUBI MAX LED 3,5W G9



ZUBI HI LED 4W G9



ZUBI LED 3,5W E14



HIGH
lumen

CERAMIC
body

LED
technology

Kanlux ZUBI LED to energooszczędne źródła, dodatkowe zalety użytkowe tych źródeł to niewielkie rozmiary a także mleczny klosz, który ogranicza efekt olśnienia oraz zapewnia elegancki i estetyczny wygląd. Konstrukcja źródeł Kanlux ZUBI gwarantuje szeroki kąt emisji światła, dzięki temu idealnie nadaje się do zastosowania we wszelkich otwartych oprawach i żyrandolach.

Materiał: ceramika

Materiał klosza: tworzywo sztuczne

Kanlux ZUBI LED are energy-saving sources. Their additional functional benefits include the small size and the milky lampshade reducing the glare effect. They provide smart and aesthetic look. The construction of Kanlux ZUBI sources guarantees a wide light emission angle, owing to which they are perfect for all open luminaires and chandeliers.

Materiał: ceramics

Lampshade material: plastic

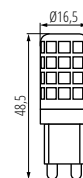

ZUBI LED 3,5W G9

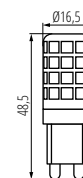

ZUBI MAX LED 3,5W G9

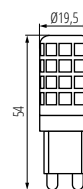

ZUBI HI LED 4W G9

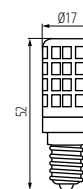

ZUBI LED 3,5W E14

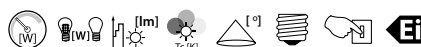

ZUBI LED 3,5W G9-VVV	24520	5905339245205	3,5	28	300	3000	320	G9	≥10000	A+
ZUBI LED 3,5W G9-CW	24521	5905339245212	3,5	28	320	6000	320	G9	≥10000	A+
ZUBI MAX LED 3,5W G9-VVV	24522	5905339245229	3,5	35	400	3000	320	G9	≥10000	A++
ZUBI HI LED 4W G9-VVV	24524	5905339245243	4	42	500	3000	280	G9	≥15000	A++
ZUBI LED 3,5W E14-VVV	24525	5905339245250	3,5	28	300	3000	300	E14	≥10000	A+

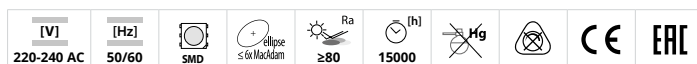

Kanlux

GIO LED G4

ŹRÓDŁO ŚWIATŁA LED ► LED LIGHT SOURCE



GIO LED G4 FL

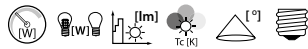

GIO LED G4 FL-WW	22662	5905339226624	1,3	11	100	3000	250	G4
GIO LED G4 FL-NW	22663	5905339226631	1,3	11	100	5000	250	G4



Kanlux GIO LED G4 to małe źródło o kącie świecenia 250°. Wysokowydajne źródła o trzonku G4 mają również bardzo długą żywotność, która wynosi 25.000 godzin.

Materiał: tworzywo sztuczne

Kanlux GIO LED G4 are small sources with illumination angle of 250°. These highly effective sources with G4 screw are also very durable - their lifetime is 25,000 hours.

Materiał: plastic

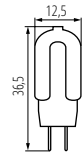

GIO LED G4 FL

Kanlux

TANO G4 SMD

ŹRÓDŁO ŚWIATŁA LED ► LED LIGHT SOURCE



TANO G4 SMD

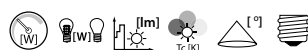

TANO G4 SMD-WW	14936	5907540962483	1,5	11	100	3000	300	G4
----------------	--------------	---------------	-----	----	-----	------	-----	----



Kanlux TANO LED to źródło światła o trzonku G4. Wysokowydajne źródło ma bardzo szeroki kąt świecenia (300°), świetnie sprawdzi się w kinkietach, lampkach nocnych czy innych oprawach, do których pasują źródła z trzonkiem G4.

Materiał: tworzywo sztuczne

Kanlux TANO LED are light sources with G4 screw. This highly durable source has a very wide illumination angle (300°), perfect for sconces, lamps and other night luminaires matching light source with G4 screw.

Materiał: plastic

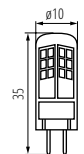

TANO G4 SMD

Kanlux LED12 SMD

ŹRÓDŁO ŚWIATEŁA LED ► LED LIGHT SOURCE

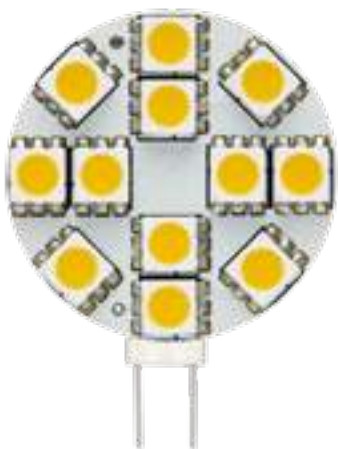

LED12 SMD

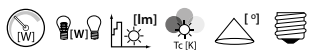

LED12.SMD.G4.VVV | **08951** | 5905339089519 | 1,5 | 14 | 130 | 3000 | 160 | G4

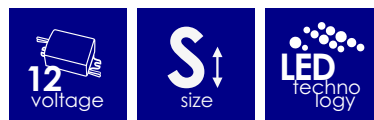
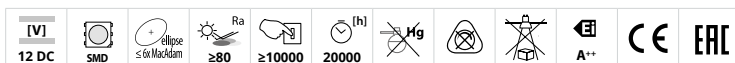

Kanlux LED12 to kapsułka z trzonkiem G4 oparta na diodach LED SMD. Kąt świecenia źródła to 160°, a jego trwałość wynosi 20.000 godzin.

do prawidłowego działania wymagany zasilacz elektroniczny LED, np. POWELED, DRIFT lub TRETO dostępny w ofercie Kanlux

Kanlux LED12 is a capsule with G4 screw based on SMD LEDs. The source's illumination angle is 160°, and its durability amounts to 20,000 hours.

LED electric power supply is needed for proper functioning, e.g. POWELED, DRIFT or TRETO available in the Kanlux product range

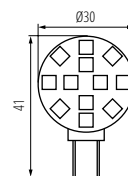

LED12 SMD G4



AR-111 LED

ŹRÓDŁO ŚWIATŁA LED ► LED LIGHT SOURCE



AR-111 LED SL/W



AR-111 LED SL/W



AR-111 LED SL/SR



HIGH
lumen

12
voltage

led

Kanlux AR-111 LED to LEDowa wersja źródeł halogenowych jednak ich wzornictwo odbiega od klasycznego wyglądu halogenów. Kanlux AR-111 LED charakteryzują się długą trwałością i niskim zużyciem energii. Źródło polecamy wszędzie tam gdzie jest widoczne ze względu na jego walory dekoracyjne. Cechą wyróżniającą te źródła jest zastosowanie markowych diod EPISTAR, co gwarantuje najwyższą jakość światła

Materiał: tworzywo sztuczne

Kanlux AR-111 LED is a LED version of halogen sources. However, their design differs from the classic look of halogens. Kanlux AR-111 LED are characterised by long durability and low energy consumption. The source is recommended in all places where it is visible due to its decorative values. These light sources stand out with the use of brand EPISTAR diodes, which ensured the highest light quality.

Materiał: plastic

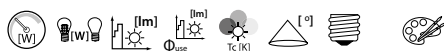

AR-111 LED SL/WW/WW	22960	5905339229601	11	66	900	710	2700	40	G53	biały white
AR-111 LED SL/CW/WW	22961	5905339229618	11	66	900	710	6500	40	G53	biały white
AR-111 LED SL/WW/SR	22962	5905339229625	11	66	900	710	2700	40	G53	srebrny silver
AR-111 LED SL/CW/SR	22963	5905339229632	11	66	900	710	6500	40	G53	srebrny silver

[W]

SMD

Ra ellipse ≤ 6x MacAdam

Ra ≥ 80

≥ 15000

25000 (h)

Hg

RoHS

A+

CE

EAC

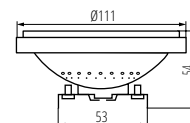

AR-111 LED SL

Kanlux

ES-111 LED

ŹRÓDŁO ŚWIATŁA LED ► LED LIGHT SOURCE



ES-111 LED SL/W



ES-111 LED SL/W



ES-111 LED SL/SR



Kanlux ES-111 LED to LEDowa wersja źródeł halogenowych jednak ich wzornictwo odbiega od klasycznego wyglądu halogenów. Kanlux ES-111 LED charakteryzują się długą trwałością i niskim zużyciem energii. Źródło polecamy wszędzie tam gdzie jest widoczne ze względu na jego walory dekoracyjne. Cechą wyróżniającą te źródła jest zastosowanie markowych diod EPISTAR, co gwarantuje najwyższą, jakość światła.

Materiał: tworzywo sztuczne

Kanlux ES-111 LED is a LED version of halogen sources. However, their design differs from the classic look of halogens. Kanlux ES-111 LED are characterised by long durability and low energy consumption. The source is recommended in all places where it is visible due to its decorative values. These light sources stand out with the use of brand EPISTAR diodes, which ensured the highest light quality.

Materiał: plastic

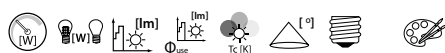

ES-111 LED SL/WW/W	22970	5905339229700	11	66	900	730	2700	40	GU10	biały white
ES-111 LED SL/CW/W	22971	5905339229717	11	66	900	730	6500	40	GU10	biały white
ES-111 LED SL/WW/SR	22972	5905339229724	11	66	900	730	2700	40	GU10	srebrny silver
ES-111 LED SL/CW/SR	22973	5905339229731	11	66	900	730	6500	40	GU10	srebrny silver

[V]	[Hz]	SMD	ellipsee sól MacAdam	Ra	≥80	≥15000	25000	Mg	RoHS	EI	CE	EAC
220-240 AC	50/60									A*		

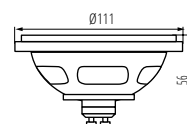

ES-111 LED SL



T8 LED GLASSV2

ŹRÓDŁO ŚWIATEŁA LED ► LED LIGHT SOURCE



T8 LED GLASSV2



HIGH
lumen

GLASS
tube

IC driver

PF > 0.9
high

Kanlux T8 LED GLASS to znana i sprawdzona linia świetlówek oparta na wysokowydajnych diodach LED SMD, które umieszczone są w mlecznym, szklanym korpusie. Wysoka jakość wykonania i dbałość o najlepszej klasy komponenty to najważniejsze cechy T8 LED GLASSV2.

Jednostronne zasilanie świetlówek LED
Materiał klosza: szkło

Kanlux T8 LED GLASS is a renown and well-proven line of fluorescent lamps based on high-efficiency SMD LEDs, placed in a milky, glass body. High quality of manufacture and care for the best quality components are the most important features of T8 LED GLASSV2.

One-way fluorescent LED-power supply
Lampshade material: glass

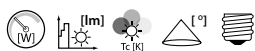

T8 LED GLASSV2 9W-WW	22658	5905339226587	9	1080	3000	200	G13
T8 LED GLASSV2 9W-NW	22654	5905339226549	9	1080	4000	200	G13
T8 LED GLASSV2 9W-CW	22659	5905339226594	9	1080	6500	200	G13
T8 LED GLASSV2 18W-WW	22656	5905339226563	18	2160	3000	200	G13
T8 LED GLASSV2 18W-NW	22655	5905339226556	18	2160	4000	200	G13
T8 LED GLASSV2 18W-CW	26060	5905339260604	18	2160	6500	200	G13
T8 LED GLASSV2 24W-NW	22657	5905339226570	24	2880	4000	200	G13
T8 LED GLASSV2 24W-CW	26061	5905339260611	24	2880	6500	200	G13

[V] 220-240 AC	[Hz] 50/60	SMD	ellipso ≤ 60 Nachdam	Ra ≥ 80	≥ 15000	25000	
		A++	ONE SIDE INPUT	°C -10÷40	CE	EAC	

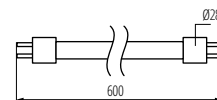

T8 LED GLASSV2 9W

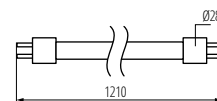

T8 LED GLASSV2 18W

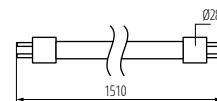

T8 LED GLASSV2 24W

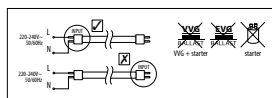

OR

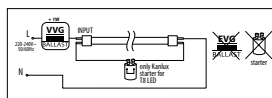

T8 LED GLASSV3

ŹRÓDŁO ŚWIATŁA LED ► LED LIGHT SOURCE



T8 LED GLASSV3



up to

140 $\frac{\text{lm}}{\text{W}}$

PF >0,9
high

IC
driver

GLASS
tube

Kanlux T8 LED GLASS to znana i sprawdzona linia świetlówek oparta na wysokowydajnych diodach LED SMD, które umieszczone są w mlecznym, szklanym korpusie. Wysoka jakość wykonania i dbałość o najlepszej klasy komponenty to najważniejsze cechy T8 LED GLASSV3.

Jednostronne zasilanie świetlówek LED
Materiał klosza: szkło

The Kanlux T8 LED GLASS is a well-known and proven line of fluorescent lamps utilising high-performance SMD LED's in a milky-coloured glass body. The high quality of workmanship and the care taken over choosing the best-quality components are the most-important features of the T8 LED GLASSV3.

One-way fluorescent LED-power supply
Lampshade material: glass



T8 LED GLASSV3 9W-NW	26062	5905339260628	9	1260	4000	250	G13
T8 LED GLASSV3 9W-CW	26063	5905339260635	9	1260	6500	250	G13
T8 LED GLASSV3 18W-NW	26064	5905339260642	18	2520	4000	250	G13
T8 LED GLASSV3 18W-CW	26065	5905339260659	18	2520	6500	250	G13
T8 LED GLASSV3 24W-NW	26066	5905339260666	24	3360	4000	250	G13
T8 LED GLASSV3 24W-CW	26067	5905339260673	24	3360	6500	250	G13

[V] 220-240 AC	[Hz] 50/60	SMD	elliptic ≤ 6x MacAdam	Ra ≥80	lifetime ≥15000	temp. range 25000	Hg

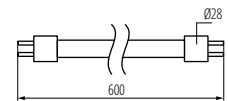

T8 LED GLASSV3 9W

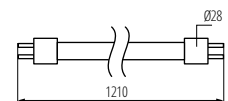

T8 LED GLASSV3 18W

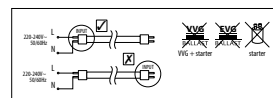

OR

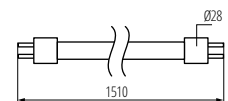
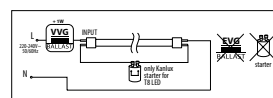

T8 LED GLASSV3 24W

Kanlux

T8 LED GLASSV3T

ŹRÓDŁO ŚWIATŁA LED ► LED LIGHT SOURCE



T8 LED GLASSV3T



up to
145 $\frac{\text{lm}}{\text{W}}$

PF > 0.9
high

IC driver

GLASS tube

Kanlux T8 LED GLASS to znana i sprawdzona linia świetlówek oparta na wysokowydajnych diodach LED SMD. Kanlux T8 LED GLASSV3T znajduje się w transparentnym, szklanym korpusie. Nowe modele charakteryzują się wyższą skutecznością świetlną i węższym kątem emisji światła wynoszącym 120°.

Jednostronne zasilanie świetlówek LED
Materiał klosza: szkło

The Kanlux T8 LED GLASS is a well-known and proven line of fluorescent lamps utilising high-performance SMD LED's. The Kanlux T8 LED GLASSV3T is fitted in a transparent glass body. The new models have a higher luminous efficacy and the narrower light-emission angle of 120°.

One-way fluorescent LED-power supply
Lampshade material: glass

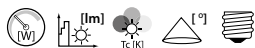

T8LED GLASSV3T 18W/NW | **26068** | 5905339260680 | 18 | 2610 | 4000 | 120 | G13

[V] 220-240 AC	[Hz] 50/60	SMD	ellipse ≤ 6x MacAdam	Ra ≥ 80	≥ 15000	25000	Hg
ONE SIDE INPUT	A++	TC	-10+40	CE	ERC		

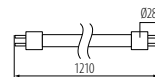
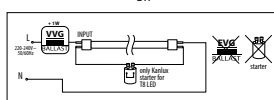
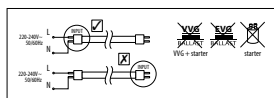

T8LED GLASSV3T



ESG LED 9W GX53



Kanlux ESG LED charakteryzuje się estetycznym wykonaniem i trwałą konstrukcją. Matowy klosz gwarantuje równomierny i szeroki rozsył światła. Biała obudowa wykonana z aluminium zapewnia prawidłowe odprowadzenie ciepła, a wysokowydajne diody LED SMD trwałość 20000h.

Materiał: stop aluminium, tworzywo sztuczne

Kanlux ESG LED is characterised by aesthetic design and durable construction. The matte shade guarantees an even and wide light distribution. White housing made of aluminium ensures proper heat dissipation and high performance SMD LEDs ensure durability for 20,000 h.

Materiał: aluminum alloy, plastic



ESG LED 9W GX53-WW	22422	5905339224224	9	55	720	575	3000	110	GX53
ESG LED 9W GX53-NW	22423	5905339224231	9	57	750	600	4000	110	GX53
ESG LED 9W GX53-CW	22424	5905339224248	9	57	750	600	6000	110	GX53

[V]	[Hz]	SMD	≤ 0.05mm	Ra ≥ 80	≥ 15000	20000	Hg			A*	CE	EAC
-----	------	-----	----------	---------	---------	-------	----	--	--	----	----	-----

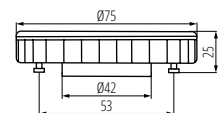

ESG LED 9W GX53

Kanlux

MODV2 LED

ŹRÓDŁO ŚWIATEŁA LED ► LED LIGHT SOURCE

NEW



MODV2 LED 12W



MODV2 LED 12W



MODV2 LED 19W



HIGH
lumen

LED
techno
logy

EASY
instala
tion

Kanlux MOD LED to profesjonalna seria modułów LED przeznaczona do modyfikacji lamp, w których mieliśmy starego typu żarówki. Moduł charakteryzuje się łatwością montażu. Kanlux MOD LED to wysokiej jakości diody LED SMD, które wyróżniają się energooszczędnością i długim czasem działania.

Materiał klosza: tworzywo sztuczne

Kanlux MOD LED is a professional series of LED modules designed for modification of lamps which used the old type of light bulbs. The module can be installed easily. Kanlux MOD LED are high-quality SMD LEDs, distinguished by energy efficiency and long lifetime.

Lampshade material: plastic



MODV2 LED 12W-WW	29300	5905339293008	12	83	1200	3000	170
MODV2 LED 12W-NW	29301	5905339293015	12	83	1200	4000	170
MODV2 LED 19W-WW	29302	5905339293022	19	120	1900	3000	170
MODV2 LED 19W-NW	29303	5905339293039	19	120	1900	4000	170

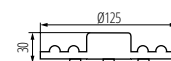

MODV2 LED 12W

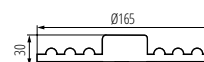

MODV2 LED 19W

[V]	[Hz]	SMD	ellipso sól MacAdam	Ra	≥80	≥15000	18000	Mg	RoHS	CE	EAC
220-240 AC	50/60								A+		

NIFO LED

ŹRÓDŁO ŚWIATŁA LED ► LED LIGHT SOURCE



NIFO LED 14W E27



Unikatowy kształt źródeł Kanlux NIFO, stanowi doskonały przykład efektywnego wykorzystania technologii z nowoczesnym designem. Kanlux NIFO, swoim kształtem oraz formą, doskonale spełnia funkcje dekoracyjne a w połączeniu z oprawami typu „zwis” efektywnie będzie wyglądać w każdym pomieszczeniu.



Materiał klosza: tworzywo sztuczne

Universal shape of Kanlux NIFO sources is a perfect example of the effective use of technology with modern design. Kanlux NIFO, in terms of its shape and form, perfectly performs decorative functions and when combined with “sag” type holders will look attractive in each room.

Lampshade material: plastic



NIFO LED 14W E27



NIFO LED 20W E27



NIFO LED 22W E27

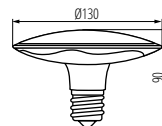

NIFO LED 14W E27

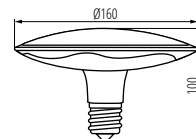

NIFO LED 20W E27

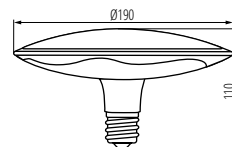

NIFO LED 22W E27

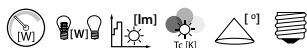

Model	Power [W]	Frequency [Hz]	Beam Angle [°]	Color Temp [K]	Life [h]	Beam Diameter [mm]	Base
NIFO LED 14W E27-WW-W	26050	5905339260505	14	80	1150	3000	160 E27
NIFO LED 20W E27-WW-W	26052	5905339260529	20	107	1650	3000	160 E27
NIFO LED 22W E27-WW-W	26054	5905339260543	22	118	1850	3000	160 E27

[V]	[Hz]	SMD	≤ 6000K	Ra ≥ 80	≥ 15000	15000	Hg	RoHS	A+	CE	EAC
-----	------	-----	---------	---------	---------	-------	----	------	----	----	-----

Kanlux

RANGO LED

ŹRÓDŁO ŚWIATEŁA LED ► LED LIGHT SOURCE



Ledowe źródło Kanlux RANGO to idealne rozwiązanie energooszczędne dla wszelkiego rodzaju lamp i naswietlaczy o trzonku R7s.

Materiał klosza: tworzywo sztuczne
Materiał klosza: szkło

LED source Kanlux RANGO is the perfect energy-saving solution for all types of lamps and floodlights with R7s screw.

Lampshade material: plastic
Lampshade material: glass



RANGO R7S SMD



RANGO MINI R7S SMD

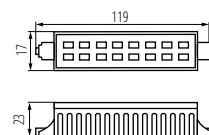

RANGO R7S SMD

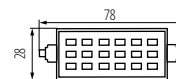

RANGO MINI R7S SMD

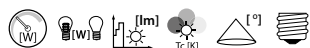

RANGO R7S SMD-WW	15098	5907540962155	6	42	500	3000	120	R7s
RANGO MINI R7S SMD-WW	15099	5907540962568	6	42	500	3000	120	R7s

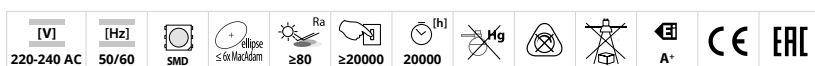

Kanlux LEDS-B

TAŚMA LED ▶ LED TAPE

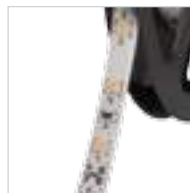

Kanlux LEDS-B to nowoczesne paski o charakterze dekoracyjnym. Idealne do zastosowań domowych, gdzie mogą stworzyć niepowtarzalne aranżacje ograniczone tylko przez naszą wyobraźnię. Charakteryzują się dużą elastycznością, dobrą przyczepnością i wysoką trwałością. W zależności od tego jakie miejsca chcemy doświetlić lub podkreślić możemy wybrać odpowiednią do naszych upodobań barwę światła.

Kanlux LEDS-B are modern strips of decorative character. Perfect for home use where they can create unique arrangements limited by our imagination only. They are characterised by high flexibility, good adhesion and high durability. Depending on the place in which we want to add more light or which we wish to highlight, we can choose the light colour suiting our preferences.



LEDS-B 4,8W/M IP00-WW	24516	5905339245168	1m = 4,8	1m = 450	3000	00	5000
LEDS-B 4,8W/M IP00-NW	24517	5905339245175	1m = 4,8	1m = 470	4000	00	5000
LEDS-B 4,8W/M IP00-CW	24518	5905339245182	1m = 4,8	1m = 500	6500	00	5000
LEDS-B 4,8W/M IP54-WW	24510	5905339245106	1m = 4,8	1m = 270	3300-3900	54	5000
LEDS-B 4,8W/M IP54-NW	24511	5905339245113	1m = 4,8	1m = 300	4000-5500	54	5000
LEDS-B 4,8W/M IP54-CW	24512	5905339245120	1m = 4,8	1m = 320	6000-7500	54	5000
LEDS-B 4,8W/M IP65-WW	24513	5905339245137	1m = 4,8	1m = 400	3000	65	5000
LEDS-B 4,8W/M IP65-NW	24514	5905339245144	1m = 4,8	1m = 425	4000	65	5000
LEDS-B 4,8W/M IP65-CW	24515	5905339245151	1m = 4,8	1m = 450	6500	65	5000

AKCESORIA ▶ ACCESSORIES

CONNECTOR 8	19030	5905339190307	Konektor do taśmy LED, CONNECTOR 8 (19030) / LED band connector, CONNECTOR 8 (19030)
CONNECTOR 8-CP	19032	5905339190321	Konektor do taśmy LED, CONNECTOR 8-CP (19032) / LED band connector, CONNECTOR 8-CP (19032)
CONNECTOR 8-CPC	19033	5905339190338	Konektor do taśmy LED, CONNECTOR 8-CPC (19033) / LED band connector, CONNECTOR 8-CPC (19033)

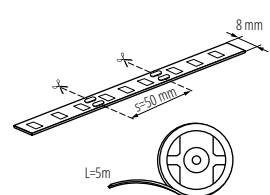

LEDS-B 4,8W-M

Kanlux LEDS-P

TAŚMA LED ▶ LED TAPE



LEDS-P 4W/M IP00; LEDS-P 10W/M IP00



LEDS-P 4W/M IP00; LEDS-P 10W/M IP00



LEDS-P 4W/M IP54; LEDS-P 10W/M IP54



Dzięki wykorzystaniu najwyższej jakości materiałów taśmy Kanlux LEDS-P gwarantują najlepsze parametry świetlne. Oryginalna taśma klejąca 3M zapewnia możliwość instalacji do różnych powierzchni, a markowe diody EDISON-a dają gwarancje niezmienności parametrów świetlnych. W zależności do potrzeb i miejsca zastosowania możemy wybrać odpowiednią moc, stopień szczelności oraz barwę światła.

With the use of the highest quality materials, Kanlux LEDS-P tapes guarantee the best lighting parameters. Original 3M adhesive tape allows for installation on various surfaces, and EDISON brand diodes guarantee steadiness of lighting parameters. Depending on our needs and the place of use, we can select adequate power, tightness class and colour of light.

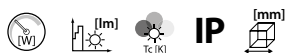

LEDS-P 4W/M IP00-WW	24010	5905339240101	1m = 4	1m = 300	3000	00	5000		
LEDS-P 4W/M IP00-CW	24011	5905339240118	1m = 4	1m = 300	6000	00	5000		
LEDS-P 4W/M IP54-WW	24012	5905339240125	1m = 4	1m = 300	3500	54	5000		
LEDS-P 4W/M IP54-CW	24013	5905339240132	1m = 4	1m = 300	5700	54	5000		
LEDS-P 10W/M IP00-WW	24120	5905339241207	1m = 10	1m = 900	3000	00	5000		
LEDS-P 10W/M IP00-CW	24121	5905339241214	1m = 10	1m = 900	6000	00	5000		
LEDS-P 10W/M IP54-WW	24122	5905339241221	1m = 10	1m = 800	3500	54	5000		
LEDS-P 10W/M IP54-CW	24123	5905339241238	1m = 10	1m = 800	5700	54	5000		

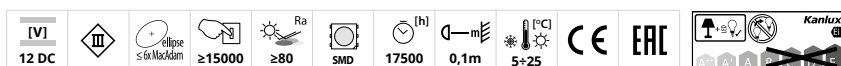

AKCESORIA ▶ ACCESSORIES

CONNECTOR 8	19030	5905339190307	Konektor do taśmy LED, CONNECTOR 8 (19030) / LED band connector, CONNECTOR 8 (19030)
CONNECTOR 8-CP	19032	5905339190321	Konektor do taśmy LED, CONNECTOR 8-CP (19032) / LED band connector, CONNECTOR 8-CP (19032)
CONNECTOR 8-CPC	19033	5905339190338	Konektor do taśmy LED, CONNECTOR 8-CPC (19033) / LED band connector, CONNECTOR 8-CPC (19033)

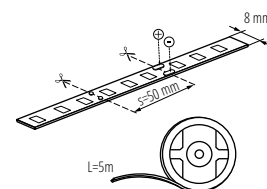

LEDS-P 4W; 10W

LEDS-B RGB

TAŚMA LED ▶ LED TAPE



LEDS-B 7.2W/M IP00RGB

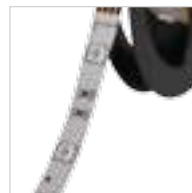

Kanlux LEDSB RGB to nowoczesne paski o charakterze dekoracyjnym. Idealne do zastosowań domowych, gdzie mogą stworzyć niepowtarzalne aranżacje ograniczone tylko przez naszą wyobraźnię. Charakteryzują się dużą elastycznością, dobrą przyczepnością i wysoką trwałością. W zależności od tego jakie miejsca chcemy doświetlić lub podkreślić możemy wybrać odpowiedni do naszych upodobań kolor świecenia.

Kanlux LEDSB RGB are modern strips of decorative character. Perfect for home use where they can create unique arrangements limited by our imagination only. They are characterised by high flexibility, good adhesion and high durability. Depending on the place in which we want to add more light or which we wish to highlight, we can choose the lighting colour suiting our preferences.



LEDS-B 7.2W/M IP00RGB



LEDS-B 7.2W/M IP54RGB



LEDS-B 7.2W/M IP65RGB

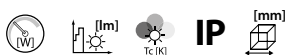

Model	Code	Part No.	1m = 7,2	1m = 130	RGB	00	5000
LEDS-B 7,2W/M IP00RGB	24530	5905339245304	1m = 7,2	1m = 130	RGB	00	5000
LEDS-B 7,2W/M IP54RGB	24532	5905339245328	1m = 7,2	1m = 130	RGB	54	5000
LEDS-B 7,2W/M IP65RGB	24531	5905339245311	1m = 7,2	1m = 130	RGB	65	5000



AKCESORIA ▶ ACCESSORIES

CONNECTOR RGB 10-CP	19036	5905339190369	Konektor do taśmy LED, CONNECTOR RGB 10-CP (19036) / LED band connector, CONNECTOR RGB 10-CP (19036)				
CONNECTOR RGB 10-CPC	19037	5905339190376	Konektor do taśmy LED, CONNECTOR RGB 10-CPC (19037) / LED band connector, CONNECTOR RGB 10-CPC (19037)				
CONNECTOR RGB 10	19038	5905339190383	Konektor do taśmy LED, CONNECTOR RGB 10 (19038) / LED band connector, CONNECTOR RGB 10 (19038)				
CONTROLLER RGB-IR20	18960	5905339189608	Kontroler RGB + pilot, CONTROLLER LED RGB-IR20 (18960) / Controller RGB + remote control, CONTROLLER LED RGB-IR20 (18960)				
CONTROLLER LED RGB-RF	22140	5905339221407	Kontroler RGB + pilot, CONTROLLER LED RGB-RF (22140) / Controller RGB + remote control, CONTROLLER LED RGB-RF (22140)				

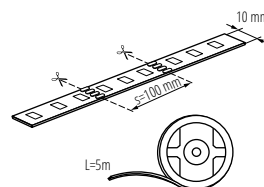

LEDS-B 7,2 W/M IP00RGB; IP54RGB; IP65RGB

LEDS SET

ZESTAW LED ► LED KIT



LEDS SET W-SE BTRY



Gotowe zestawy pasków LED do samodzielnego montażu. Każdy zestaw Kanlux LED SET posiada samodzielne źródło zasilania (bateryjne lub zasilacz), dzięki któremu możemy zamontować je w każdym miejscu. W zależności od potrzeb możemy wybrać zestaw z czujnikiem ruchu, włącznikiem zbliżeniowym lub dotykowym.

Materiał: tworzywo sztuczne

Ready sets of LED strips for self-assembly. Each Kanlux LED SET has an independent power source (battery or power supply) owing to which we can mount them in any place. Depending on our needs, we can choose a set with a motion detector, proximity or touch switch.

Materiał: plastic



LEDS SET S-DIM IR



LEDS SET S-DIM TS



LEDS SET W-SE ACCU



LEDS SET B-SE SGL

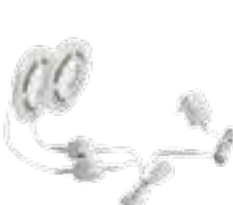

LEDS SET B-SE DBL

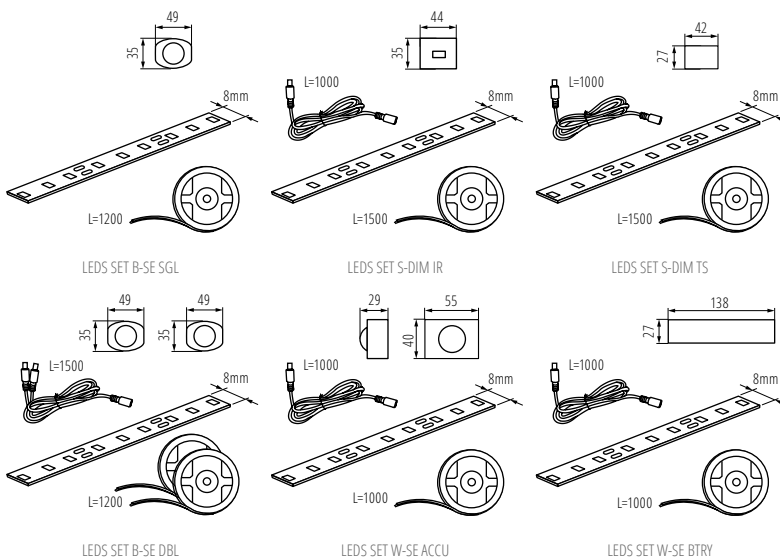

			(lm)	(h)	(Ra)
LEDS SET S-DIM IR	26320	5905339263209	7,5	450	3000-3900
LEDS SET S-DIM TS	26321	5905339263216	7,5	450	3000-3900
LEDS SET W-SE ACCU	26322	5905339263223	2,4	180	3000-3900
LEDS SET W-SE BTRY	26323	5905339263230	2,4	180	3000-3900
LEDS SET B-SE SGL	26324	5905339263247	3,3	240	3000-3900
LEDS SET B-SE DBL	26325	5905339263254	6,5	2 x 240	3000-3900

IP 54/20				
	≤ 60 MacAdam	≥ 15000	≥ 80	
		15000 (h)	0,1m	



Kanlux

CONTROLLER

KONTROLER DO TAŚM LED ► CONTROLLER FOR LED TAPES



Materiał: tworzywo sztuczne

Materiał: plastic



CONTROLLER RGB-IR20



CONTROLLER LED RGB-RF

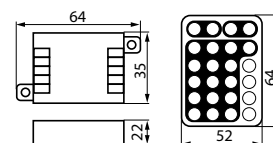

CONTROLLER RGB-IR20



CONTROLLER RGB-IR20	18960	5905339189608	biały white	max 6	max 5
CONTROLLER LED RGB-RF	22140	5905339221407	biały white	max 15	max 25

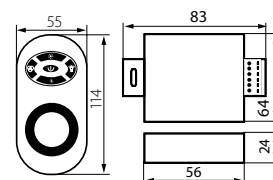

CONTROLLER LED RGB-RF



Kanlux

PROFILO A

PROFIL ALUMINIOWY ► ALUMINIUM PROFILE



PROFILO A



Uniwersalny profil dekoracyjno-oświetleniowy

Materiał: stop aluminium

Multi-purpose decorative lighting profile

Materiał: aluminium alloy



PROFILO A | 19160 | 5905339191601 | anodowany | anodised | 1000



AKCESORIA ► ACCESSORIES

SHADE A-FR	19170	5905339191700	Klosz transparentny do profilu aluminium, komplet 10 szt., SHADE A-FR (19170) / Transparent light cover for aluminium profile, package 10 pcs., SHADE A-FR (19170)
HANDLE A	19190	5905339191908	Uchwyt mocujący + zaślepki do profilu aluminium, HANDLE A (19190) / Mounting bracket + aluminium profile caps, HANDLE A (19190)

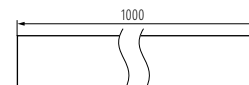
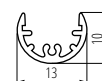

PROFILO A

PROFILO B

PROFIL ALUMINIOWY ► ALUMINIUM PROFILE



PROFILO B



Mały, nawierzchniowy uniwersalny profil dekoracyjno-oświetleniowy

Materiał: stop aluminium

Small, surface, multi-purpose decorative lighting profile

Material: aluminum alloy

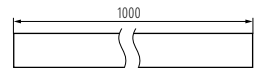
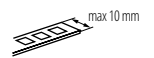

PROFILO B

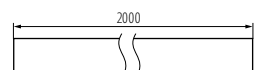

PROFILO B 2M



PROFILO B	19161	5905339191618	anodowany anodised	1000
PROFILO B 2m	26540	5905339265401	anodowany anodised	2000



AKCESORIA ► ACCESSORIES

SHADE B/F-FR	26568	5905339265685	Klosz szroniony do profilu aluminiowego, komplet 10 szt., SHADE B/F-FR(26568) / Frosted light cover for aluminium profile, package 10 pcs., SHADE B/F-FR(26568)
SHADE B/F-FR 2M	26570	5905339265708	Klosz szroniony do profilu aluminiowego, komplet 10 szt., SHADE B/F-FR 2M(26570) / Frosted light cover for aluminium profile, package 10 pcs., SHADE B/F-FR 2M(26570)
SHADE B/F-W	26569	5905339265692	Klosz biały do profilu aluminiowego, komplet 10 szt., SHADE B/F-W(26569) / White shade for aluminium profile, package 10 pcs., SHADE B/F-W(26569)
SHADE B/F-W 2M	26571	5905339265715	Klosz biały do profilu aluminiowego, komplet 10 szt., SHADE B/F-W 2M(26571) / White shade for aluminium profile, package 10 pcs., SHADE B/F-W 2M(26571)
HANDLE B/F	26596	5905339265968	Uchwyt mocujący profil aluminiowy, HANDLE B/F (26596) / Aluminium profile mounting bracket, HANDLE B/F (26596)
CONNECT-L B	26604	5905339266040	Łącznik do profilu aluminiowego, CONNECT-L B (26604) / Aluminium profile connector, CONNECT-L B (26604)
STOPPER B	19181	5905339191816	Zaślepka do profilu aluminiowego, STOPPER B (19181) / Aluminium profile cap, STOPPER B (19181)





PROFILO C

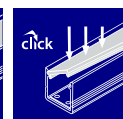
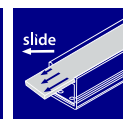

Kątowy (30° i 60°) profil dekoracyjno-oświetleniowy

Material: stop aluminium

Angular (30° and 60°) decorative lighting profile

Material: aluminum alloy



PROFILO C	19162	5905339191625	anodowany anodised	1000
PROFILO C 2m	26541	5905339265418	anodowany anodised	2000



AKCESORIA ► ACCESSORIES

SHADE C/D/E/I-FR	26572	5905339265722	Klosz szroniony do profilu aluminiowego, komplet 10 szt., SHADE C/D/E/I-FR(26572) / Frosted light cover for aluminium profile, package 10 pcs., SHADE C/D/E/I-FR(26572)
SHADE C/D/E/I-FR2M	26573	5905339265739	Klosz szroniony do profilu aluminiowego, komplet 10 szt., SHADE C/D/E/I-FR2M(26573) / Frosted light cover for aluminium profile, package 10 pcs., SHADE C/D/E/I-FR2M(26573)
SHADE C/D/E/I-W	26574	5905339265746	Klosz biały do profilu aluminiowego, komplet 10 szt., SHADE C/D/E/I-W(26574) / White shade for aluminium profile, package 10 pcs., SHADE C/D/E/I-W(26574)
SHADE C/D/E/I-W2M	26575	5905339265753	Klosz biały do profilu aluminiowego, komplet 10 szt., SHADE C/D/E/I-W2M(26575) / White shade for aluminium profile, package 10 pcs., SHADE C/D/E/I-W2M(26575)
SHADE CK C/D/E/I-FR	26576	5905339265760	Klosz transparentny do profilu aluminiowego, komplet 10 szt., SHADE CK C/D/E/I-FR(26576) / Transparent light cover for aluminium profile, package 10 pcs., SHADE CK C/D/E/I-FR(26576)
SHADE CK C/D/E/I-FR2M	26577	5905339265777	Klosz transparentny do profilu aluminiowego, komplet 10 szt., SHADE CK C/D/E/I-FR2M(26577) / Transparent light cover for aluminium profile, package 10 pcs., SHADE CK C/D/E/I-FR2M(26577)
SHADE CK C/D/E/I-W	26578	5905339265784	Klosz biały do profilu aluminiowego, komplet 10 szt., SHADE CK C/D/E/I-W(26578) / White shade for aluminium profile, package 10 pcs., SHADE CK C/D/E/I-W(26578)
SHADE CK C/D/E/I-W2M	26579	5905339265791	Klosz biały do profilu aluminiowego, komplet 10 szt., SHADE CK C/D/E/I-W2M(26579) / White shade for aluminium profile, package 10 pcs., SHADE CK C/D/E/I-W2M(26579)
HANDLE C/D/E/I	26597	5905339265975	Uchwyt mocujący profil aluminiowy, HANDLE C/D/E/I(26597) / Aluminium profile mounting bracket, HANDLE C/D/E/I(26597)
CONNECT C/D/E/I	26563	5905339265630	Łącznik do profilu aluminiowego, CONNECT C/D/E/I(26563) / Aluminium profile connector, CONNECT C/D/E/I(26563)
CONNECT-L C	26562	5905339265623	Łącznik do profilu aluminiowego, CONNECT-L C(26562) / Aluminium profile connector, CONNECT-L C(26562)
STOPPER C	19182	5905339191823	Zasłepka do profilu aluminiowego, STOPPER C(19182) / Aluminium profile cap, STOPPER C(19182)

slide

click

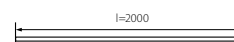
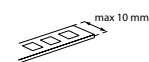

PROFILO C 2M

PROFILO D

PROFIL ALUMINIOWY ► ALUMINIUM PROFILE



PROFILO D

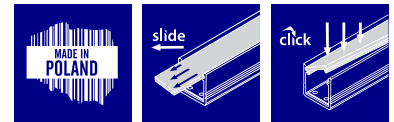

Nawierzchniowy profil dekoracyjno-oświetleniowy

Materiał: stop aluminium

Surface decorative lighting profile

Material: aluminum alloy



PROFILO D	19163	5905339191632	anodowany anodised	1000
PROFILO D 2m	26542	5905339265425	anodowany anodised	2000



AKCESORIA ► ACCESSORIES

SHADE C/D/E/I-FR	26572	5905339265722	Klosz szroniony do profilu aluminiowego, komplet 10 szt., SHADE C/D/E/I-FR(26572) / Frosted light cover for aluminium profile, package 10 pcs., SHADE C/D/E/I-FR(26572)
SHADE C/D/E/I-FR2M	26573	5905339265739	Klosz szroniony do profilu aluminiowego, komplet 10 szt., SHADE C/D/E/I-FR 2M(26573) / Frosted light cover for aluminium profile, package 10 pcs., SHADE C/D/E/I-FR 2M(26573)
SHADE C/D/E/I-W	26574	5905339265746	Klosz biały do profilu aluminiowego, komplet 10 szt., SHADE C/D/E/I-W(26574) / White shade for aluminium profile, package 10 pcs., SHADE C/D/E/I-W(26574)
SHADE C/D/E/I-W2M	26575	5905339265753	Klosz biały do profilu aluminiowego, komplet 10 szt., SHADE C/D/E/I-W 2M(26575) / White shade for aluminium profile, package 10 pcs., SHADE C/D/E/I-W 2M(26575)
SHADE CK C/D/E/I-FR	26576	5905339265760	Klosz transparentny do profilu aluminiowego, komplet 10 szt., SHADE CK C/D/E/I-FR(26576) / Transparent light cover for aluminium profile, package 10 pcs., SHADE CK C/D/E/I-FR(26576)
SHADE CK C/D/E/I-FR2M	26577	5905339265777	Klosz transparentny do profilu aluminiowego, komplet 10 szt., SHADE CK C/D/E/I-FR2M(26577) / Transparent light cover for aluminium profile, package 10 pcs., SHADE CK C/D/E/I-FR2M(26577)
SHADE CK C/D/E/I-W	26578	5905339265784	Klosz biały do profilu aluminiowego, komplet 10 szt., SHADE CK C/D/E/I-W(26578) / White shade for aluminium profile, package 10 pcs., SHADE CK C/D/E/I-W(26578)
SHADE CK C/D/E/I-W2M	26579	5905339265791	Klosz biały do profilu aluminiowego, komplet 10 szt., SHADE CK C/D/E/I-W 2M(26579) / White shade for aluminium profile, package 10 pcs., SHADE CK C/D/E/I-W 2M(26579)
HANDLE C/D/E/I	26597	5905339265975	Uchwyt mocujący profil aluminiowy, HANDLE C/D/E/I (26597) / Aluminium profile mounting bracket, HANDLE C/D/E/I (26597)
CONNECT C/D/E/I	26563	5905339265630	Łącznik do profilu aluminiowego, CONNECT C/D/E/I(26563) / Aluminium profile connector, CONNECT C/D/E/I(26563)
STOPPER D	19183	5905339191830	Zaślepka do profilu aluminiowego, STOPPER D (19183) / Aluminium profile cap, STOPPER D (19183)

slide

click

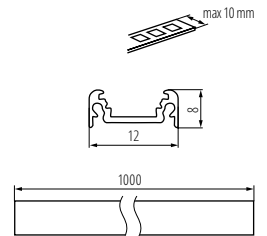

PROFILO D

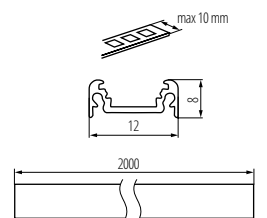

PROFILO D 2M

PROFILO E

PROFIL ALUMINIOWY ► ALUMINIUM PROFILE



PROFILO E

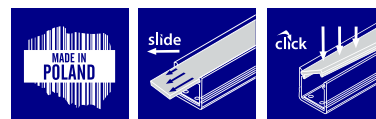

Kątowy (45°) profil dekoracyjno-oświetleniowy

Materiał: stop aluminium

Angular (45°) decorative lighting profile

Material: aluminum alloy



PROFILO E	19164	5905339191649	anodowany anodised	1000
PROFILO E 2m	26543	5905339265432	anodowany anodised	2000



AKCESORIA ► ACCESSORIES

SHADE C/D/E/I-FR	26572	5905339265722	Klosz szroniony do profilu aluminiowego, komplet 10 szt., SHADE C/D/E/I-FR(26572) / Frosted light cover for aluminium profile, package 10 pcs., SHADE C/D/E/I-FR(26572)
SHADE C/D/E/I-FR 2M	26573	5905339265739	Klosz szroniony do profilu aluminiowego, komplet 10 szt., SHADE C/D/E/I-FR 2M(26573) / Frosted light cover for aluminium profile, package 10 pcs., SHADE C/D/E/I-FR 2M(26573)
SHADE C/D/E/I-W	26574	5905339265746	Klosz biały do profilu aluminiowego, komplet 10 szt., SHADE C/D/E/I-W(26574) / White shade for aluminium profile, package 10 pcs., SHADE C/D/E/I-W(26574)
SHADE C/D/E/I-W 2M	26575	5905339265753	Klosz biały do profilu aluminiowego, komplet 10 szt., SHADE C/D/E/I-W 2M(26575) / White shade for aluminium profile, package 10 pcs., SHADE C/D/E/I-W 2M(26575)
SHADE CK C/D/E/I-FR	26576	5905339265760	Klosz transparentny do profilu aluminiowego, komplet 10 szt., SHADE CK C/D/E/I-FR(26576) / Transparent light cover for aluminium profile, package 10 pcs., SHADE CK C/D/E/I-FR(26576)
SHADE CK C/D/E/I-FR 2M	26577	5905339265777	Klosz transparentny do profilu aluminiowego, komplet 10 szt., SHADE CK C/D/E/I-FR 2M(26577) / Transparent light cover for aluminium profile, package 10 pcs., SHADE CK C/D/E/I-FR 2M(26577)
SHADE CK C/D/E/I-W	26578	5905339265784	Klosz biały do profilu aluminiowego, komplet 10 szt., SHADE CK C/D/E/I-W(26578) / White shade for aluminium profile, package 10 pcs., SHADE CK C/D/E/I-W(26578)
SHADE CK C/D/E/I-W 2M	26579	5905339265791	Klosz biały do profilu aluminiowego, komplet 10 szt., SHADE CK C/D/E/I-W 2M(26579) / White shade for aluminium profile, package 10 pcs., SHADE CK C/D/E/I-W 2M(26579)
HANDLE C/D/E/I	26597	5905339265975	Uchwyt mocujący profil aluminiowy, HANDLE C/D/E/I (26597) / Aluminium profile mounting bracket, HANDLE C/D/E/I (26597)
CONNECT C/D/E/I	26563	5905339265630	Łącznik do profilu aluminiowego, CONNECT C/D/E/I(26563) / Aluminium profile connector, CONNECT C/D/E/I(26563)
STOPPER E	19184	5905339191847	Zasłepka do profilu aluminiowego, STOPPER E (19184) / Aluminium profile cap, STOPPER E (19184)

slide

click

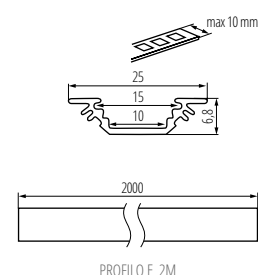
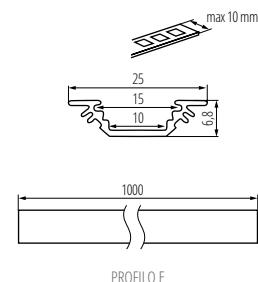

PROFILO F

PROFIL ALUMINIOWY ► ALUMINIUM PROFILE



PROFILO F

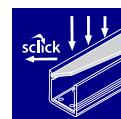

Uniwersalny profil dekoracyjno-oświetleniowy

Materiał: stop aluminium

Multi-purpose decorative lighting profile

Material: aluminum alloy



PROFILO F	26552	5905339265524	anodowany anodised	1000
PROFILO F 2m	26553	5905339265531	anodowany anodised	2000



AKCESORIA ► ACCESSORIES

SHADE B/F-FR	26568	5905339265685	Klosz szroniony do profilu aluminium, komplet 10 szt., SHADE B/F-FR(26568) / Frosted light cover for aluminium profile, package 10 pcs., SHADE B/F-FR(26568)
SHADE B/F-FR 2M	26570	5905339265708	Klosz szroniony do profilu aluminium, komplet 10 szt., SHADE B/F-FR 2M(26570) / Frosted light cover for aluminium profile, package 10 pcs., SHADE B/F-FR 2M(26570)
SHADE B/F-W	26569	5905339265692	Klosz biały do profilu aluminium, komplet 10 szt., SHADE B/F-W(26569) / White shade for aluminium profile, package 10 pcs., SHADE B/F-W(26569)
SHADE B/F-W 2M	26571	5905339265715	Klosz biały do profilu aluminium, komplet 10 szt., SHADE B/F-W 2M(26571) / White shade for aluminium profile, package 10 pcs., SHADE B/F-W 2M(26571)
HANDLE B/F	26596	5905339265968	Uchwyt mocujący profil aluminium, HANDLE B/F (26596) / Aluminium profile mounting bracket, HANDLE B/F (26596)
STOPPER F	26590	5905339265906	Zaślepki do profilu aluminium, STOPPER F (26590) / Aluminium profile caps, STOPPER F (26590)

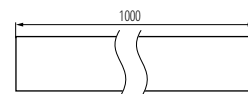

PROFILO F

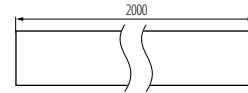

PROFILO F 2M

PROFILO G

PROFIL ALUMINIOWY ► ALUMINIUM PROFILE



PROFILO G



Wpustowy profil dekoracyjno-oświetleniowy do podłóg

Materiał: stop aluminium

Recessed decorative lighting profile

Material: aluminium alloy



PROFILO G	26558	5905339265586	anodowany anodised	1000
PROFILO G 2m	26559	5905339265593	anodowany anodised	2000



AKCESORIA ► ACCESSORIES

SHADE CK G	26580	5905339265807	Klosz biały do profilu aluminium, komplet 10 szt., SHADE CK G(26580) / White shade for aluminium profile, package 10 pcs., SHADE CK G(26580)
SHADE CK G 2M	26581	5905339265814	Klosz biały do profilu aluminium, komplet 5 szt., SHADE CK G 2M(26581) / White shade for aluminium profile, package 5 pcs., SHADE CK G 2M(26581)
HANDLE G	26598	5905339265982	Uchwyt mocujący profil aluminium, HANDLE G (26598) / Aluminium profile mounting bracket, HANDLE G (26598)
STOPPER G	26592	5905339265920	Zasłepki do profilu aluminium, STOPPER G (26592) / Aluminium profile caps, STOPPER G (26592)
SEALINGS G	26602	5905339266026	Uszczelka do profilu aluminium, SEALINGS G (26602) / Aluminium profile gasket, SEALINGS G (26602)

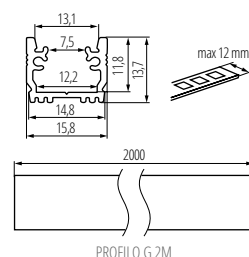
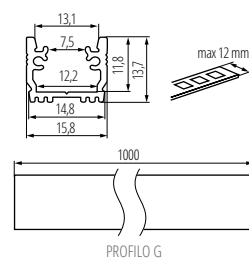

PROFILO H

PROFIL ALUMINIOWY ► ALUMINIUM PROFILE



PROFILO H



Profil dekoracyjno-oświetleniowy do zastosowań giętych w dwóch kierunkach jednej płaszczyzny

Materiał: stop aluminium

Flexible decorative lighting profile - possibilities of bending in two directions

Materiał: aluminium alloy



PROFILO H	26560	5905339265609	anodowany anodised	1000
PROFILO H 2m	26561	5905339265616	anodowany anodised	2000



AKCESORIA ► ACCESSORIES

SHADE-O H-W	26586	5905339265869	Klosz biały do profilu aluminiowego, komplet 10 szt., SHADE-O H-W(26586) / White shade for aluminium profile, package 10 pcs., SHADE-O H-W(26586)
SHADE-O H-W 2m	26587	5905339265876	Klosz biały do profilu aluminiowego, komplet 5 szt., SHADE-O H-W 2m(26587) / White shade for aluminium profile, package 5 pcs., SHADE-O H-W 2m(26587)
SHADE-U H-FR	26582	5905339265821	Klosz transparentny do profilu aluminiowego, komplet 10 szt., SHADE-U H-FR(26582) / Transparent light cover for aluminium profile, package 10 pcs., SHADE-U H-FR(26582)
SHADE-U H-FR 2m	26583	5905339265838	Klosz transparentny do profilu aluminiowego, komplet 5 szt., SHADE-U H-FR 2m(26583) / Transparent light cover for aluminium profile, package 5 pcs., SHADE-U H-FR 2m(26583)
SHADE-U H-W	26584	5905339265845	Klosz do profilu aluminiowego, komplet 10 szt., SHADE-U H-W(26584) / Shade for aluminium profile, package 10 pcs., SHADE-U H-W(26584)
SHADE-U H-W 2m	26585	5905339265852	Klosz biały do profilu aluminiowego, komplet 5 szt., SHADE-U H-W 2m(26585) / White shade for aluminium profile, package 5 pcs., SHADE-U H-W 2m(26585)
HANDLE H	26599	5905339265999	Uchwyt mocujący profil aluminiowy, HANDLE H (26599) / Aluminium profile mounting bracket, HANDLE H (26599)
HANDLE SIDE H	26600	5905339266002	Uchwyt mocujący profil aluminiowy, HANDLE SIDE H (26600) / Aluminium profile mounting bracket, HANDLE SIDE H (26600)
STOPPER-U H	26593	5905339265937	Zasłepki do profilu aluminiowego, STOPPER-U H (26593) / Aluminium profile caps, STOPPER-U H (26593)
STOPPER-O H	26594	5905339265944	Zasłepki do profilu aluminiowego, STOPPER-O H (26594) / Aluminium profile caps, STOPPER-O H (26594)

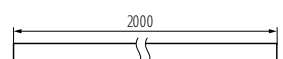
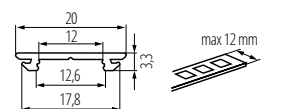
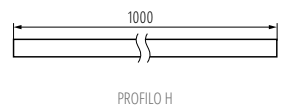
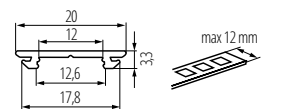

PROFILO H 2M

PROFILO I

PROFIL ALUMINIOWY ► ALUMINIUM PROFILE



PROFILO I



PROFILO I-W

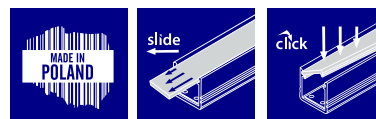

Wpustowy profil dekoracyjno-oświetleniowy

Materiał: stop aluminium

Recessed decorative lighting profile

Material: aluminum alloy



[mm]

PROFILO I	26554	5905339265548	anodowany anodised	1000
PROFILO I 2m	26555	5905339265555	anodowany anodised	2000
PROFILO I-W	26556	5905339265562	biały white	1000
PROFILO I-W 2m	26557	5905339265579	biały white	2000



AKCESORIA ► ACCESSORIES

SHADE C/D/E/I-FR	26572	5905339265722	Klosz szroniony do profilu aluminiowego, komplet 10 szt., SHADE C/D/E/I-FR(26572) / Frosted light cover for aluminium profile, package 10 pcs., SHADE C/D/E/I-FR(26572)
SHADE C/D/E/I-FR2M	26573	5905339265739	Klosz szroniony do profilu aluminiowego, komplet 10 szt., SHADE C/D/E/I-FR2M(26573) / Frosted light cover for aluminium profile, package 10 pcs., SHADE C/D/E/I-FR2M(26573)
SHADE C/D/E/I-W	26574	5905339265746	Klosz biały do profilu aluminiowego, komplet 10 szt., SHADE C/D/E/I-W(26574) / White shade for aluminium profile, package 10 pcs., SHADE C/D/E/I-W(26574)
SHADE C/D/E/I-W2M	26575	5905339265753	Klosz biały do profilu aluminiowego, komplet 10 szt., SHADE C/D/E/I-W2M(26575) / White shade for aluminium profile, package 10 pcs., SHADE C/D/E/I-W2M(26575)
SHADE CK C/D/E/I-FR	26576	5905339265760	Klosz transparentny do profilu aluminiowego, komplet 10 szt., SHADE CK C/D/E/I-FR(26576) / Transparent light cover for aluminium profile, package 10 pcs., SHADE CK C/D/E/I-FR(26576)
SHADE CK C/D/E/I-FR2M	26577	5905339265777	Klosz transparentny do profilu aluminiowego, komplet 10 szt., SHADE CK C/D/E/I-FR2M(26577) / Transparent light cover for aluminium profile, package 10 pcs., SHADE CK C/D/E/I-FR2M(26577)
SHADE CK C/D/E/I-W	26578	5905339265784	Klosz biały do profilu aluminiowego, komplet 10 szt., SHADE CK C/D/E/I-W(26578) / White shade for aluminium profile, package 10 pcs., SHADE CK C/D/E/I-W(26578)
SHADE CK C/D/E/I-W2M	26579	5905339265791	Klosz biały do profilu aluminiowego, komplet 10 szt., SHADE CK C/D/E/I-W2M(26579) / White shade for aluminium profile, package 10 pcs., SHADE CK C/D/E/I-W2M(26579)
HANDLE C/D/E/I	26597	5905339265975	Uchwyt mocujący profil aluminiowy, HANDLE C/D/E/I (26597) / Aluminium profile mounting bracket, HANDLE C/D/E/I (26597)
CONNECT C/D/E/I	26563	5905339265630	Łącznik do profilu aluminiowego, CONNECT C/D/E/I(26563) / Aluminium profile connector, CONNECT C/D/E/I(26563)
SPRING I	26601	5905339266019	Uchwyt sprężynowy do profilu aluminiowego, SPRING I (26601) / Spring-loaded bracket for aluminium profile, SPRING I (26601)
STOPPER I	26591	5905339265913	Zasłepki do profilu aluminiowego, STOPPER I (26591) / Aluminium profile caps, STOPPER I (26591)
STOPPER I-W	26603	5905339266033	Zasłepki do profilu aluminiowego, STOPPER I-W (26603) / Aluminium profile caps, STOPPER I-W (26603)

← slide

↑ click

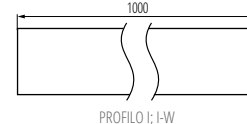
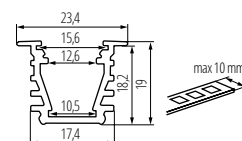

PROFILO I; I-W

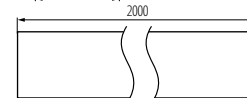
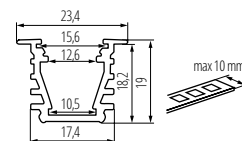

PROFILO I; I-W 2M

PROFILO J

PROFIL ALUMINIOWY ► ALUMINIUM PROFILE



PROFILO J



PROFILO J-W

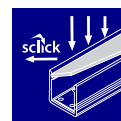

Nawierzchniowy profil dekoracyjno-oświetleniowy

Materiał: stop aluminium

Surface decorative lighting profile

Material: aluminum alloy



PROFILO J	26544	5905339265449	anodowany anodised	1000
PROFILO J 2M	26545	5905339265456	anodowany anodised	2000
PROFILO J-W	26546	5905339265463	biały white	1000
PROFILO J-W 2M	26547	5905339265470	biały white	2000



AKCESORIA ► ACCESSORIES

SHADE J/K-FR	26564	5905339265647	Klosz szroniony do profilu aluminiowego, komplet 10 szt., SHADE J/K-FR(26564) / Frosted light cover for aluminium profile, package 10 pcs., SHADE J/K-FR(26564)
SHADE J/K-FR 2m	26566	5905339265661	Klosz szroniony do profilu aluminiowego, komplet 10 szt., SHADE J/K-FR 2m(26566) / Frosted light cover for aluminium profile, package 10 pcs., SHADE J/K-FR 2m(26566)
SHADE J/K-W	26565	5905339265654	Klosz biały do profilu aluminiowego, komplet 10 szt., SHADE J/K-W(26565) / White shade for aluminium profile, package 10 pcs., SHADE J/K-W(26565)
SHADE J/K-W 2m	26567	5905339265678	Klosz biały do profilu aluminiowego, komplet 10 szt., SHADE J/K-W 2m(26567) / White shade for aluminium profile, package 10 pcs., SHADE J/K-W 2m(26567)
HANDLE J/K	26595	5905339265951	Uchwyt mocujący profil aluminiowy, HANDLE J/K (26595) / Aluminium profile mounting bracket, HANDLE J/K (26595)
STOPPER J	26588	5905339265883	Zasłepki do profilu aluminiowego, STOPPER J (26588) / Aluminium profile caps, STOPPER J (26588)
STOPPER J-W	26605	5905339266057	Zasłepki do profilu aluminiowego, STOPPER J-W (26605) / Aluminium profile caps, STOPPER J-W (26605)

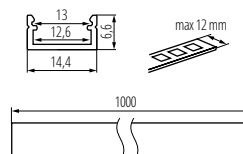

PROFILO J; J-W

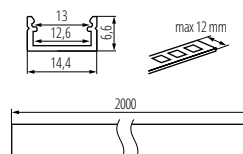

PROFILO J; J-W 2M

PROFILO K

PROFIL ALUMINIOWY ► ALUMINIUM PROFILE



PROFILO K



PROFILO K-W

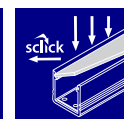

Wpustowy profil dekoracyjno-oświetleniowy

Materiał: stop aluminium

Recessed decorative lighting profile

Materiał: aluminium alloy



PROFILO K	26548	5905339265487	anodowany anodised	1000
PROFILO K.2m	26549	5905339265494	anodowany anodised	2000
PROFILO K-W	26550	5905339265500	biały white	1000
PROFILO K-W.2m	26551	5905339265517	biały white	2000



AKCESORIA ► ACCESSORIES

SHADE J/K-FR	26564	5905339265647	Klosz szroniony do profilu aluminiowego, komplet 10 szt., SHADE J/K-FR(26564) / Frosted light cover for aluminium profile, package 10 pcs., SHADE J/K-FR(26564)
SHADE J/K-FR.2m	26566	5905339265661	Klosz szroniony do profilu aluminiowego, komplet 10 szt., SHADE J/K-FR.2m(26566) / Frosted light cover for aluminium profile, package 10 pcs., SHADE J/K-FR.2m(26566)
SHADE J/K-W	26565	5905339265654	Klosz biały do profilu aluminiowego, komplet 10 szt., SHADE J/K-W(26565) / White shade for aluminium profile, package 10 pcs., SHADE J/K-W(26565)
SHADE J/K-W.2m	26567	5905339265678	Klosz biały do profilu aluminiowego, komplet 10 szt., SHADE J/K-W.2m(26567) / White shade for aluminium profile, package 10 pcs., SHADE J/K-W.2m(26567)
HANDLE J/K	26595	5905339265951	Uchwyt mocujący profil aluminiowy, HANDLE J/K (26595) / Aluminium profile mounting bracket, HANDLE J/K (26595)
STOPPER K	26589	5905339265890	Zasłepki do profilu aluminiowego, STOPPER K (26589) / Aluminium profile caps, STOPPER K (26589)
STOPPER K-W	26606	5905339266064	Zasłepki do profilu aluminiowego, STOPPER K-W (26606) / Aluminium profile caps, STOPPER K-W (26606)

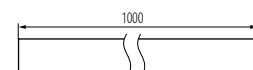
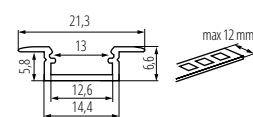

PROFILO K; K-W

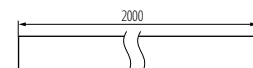
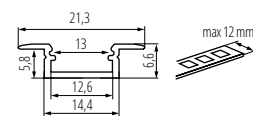

PROFILO K; K-W.2M

GIVRO LED

WAŻ ŚWIETLNY ▶ ROPE LIGHTS



GIVRO LED-CW 50M; CW; WW



GIVRO LED-GN 50M



GIVRO LED-BL 50M



GIVRO LED-RE 50M



GIVRO LED-CW 50M	08630	5905339086303	125	chłodnobiała cold white
GIVRO LED-BL 50M	08631	5905339086310	125	niebieska blue
GIVRO LED-RE 50M	08632	5905339086327	125	czerwona red
GIVRO LED-GN 50M	08633	5905339086334	125	zielona green
GIVRO LED-Y 50M	08634	5905339086341	125	żółta yellow
GIVRO LED-WW 50M	08642	5905339086426	125	ciepłobiała Warm white

IVI 220-240 DC	IP 44	CE
50000 [h]	-5+25 [°C]	0,1 m



Kanlux GIVRO LED to 50 metrowe węże świetlne dostępne w różnych barwach. Do jego prawidłowego działania wymagane jest urządzenie zasilające Kanlux GIVRO PR SET. Waż można dzielić na segmenty, a w miejscu odcięcia możliwe jest ponowne połączenie w dowolny układ dzięki elementom systemu Kanlux GIVRO LED. Za pomocą kolorowych węży LED możliwe jest wydobyć charakteru pomieszczenia. Kanlux GIVRO LED można zastosować również na zewnątrz budynków: balkonach, altankach i ogrodach.

waż o długości 50m

możliwość dzielenia pasków LED na segmenty (1m = 36 x LED)

do prawidłowego działania wymagane jest urządzenie zasilające GIVRO PR SET dostępne w ofercie Kanlux

Kanlux GIVRO LED are 50-meter rope lights available in different colours. Power supply device Kanlux GIVRO PR SET is required for its proper functioning. The rope can be divided into segments and it is possible to reconnect it at the cut-off point into any arrangement owing to the elements of Kanlux GIVRO LED system. With colourful LED ropes, it is possible to bring out the room's character. Kanlux GIVRO LED can also be used outdoors: in balconies, gazebos and gardens.

50m long rope

the possibility to divide the LED strips into segments (1m = 36 x LED)

power cord of GIVRO PR SET, available in Kanlux offer, is needed for proper operation

AKCESORIA ▶ ACCESSORIES

GIVRO PR SET	08637	5905339086372	Przewód+ zestaw łączników, GIVRO PR SET(8637) / Conductor + set of connectors, GIVRO PR SET(8637)
GIVRO-90L	08636	5905339086365	Łącznik kolankowy, GIVRO-90L(8636) / Elbow connector, GIVRO-90L(8636)
GIVRO-I	08639	5905339086396	Łącznik typu „I”, GIVRO-I(8639) / Connector, type „I”, GIVRO-I(8639)
GIVRO-T	08641	5905339086419	Łącznik typu „T”, GIVRO-T (8641) / Connector, type „T”, GIVRO-T (8641)
GIVRO-X	08635	5905339086358	Łącznik typu „X”, GIVRO-X(8635) / Connector, type „X”, GIVRO-X(8635)
GIVRO-PEND	08640	5905339086402	Plastikowa zawieszka, komplet 10szt., GIVRO-PEND (8640) / Plastic tag, package 10pcs., GIVRO-PEND (8640)
GIVRO-Z	08638	5905339086389	Zasłlepka, komplet 3 szt., GIVRO-Z(8638) / Stopper, package 3 pcs., GIVRO-Z(8638)

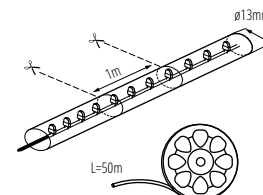

GIVRO LED 50M

Kanlux

GLH

HALOGENOWE ŹRÓDŁO ŚWIATŁA ► HALIDE LIGHT SOURCE



GLH/CL 28W; 42W; 52W; 70W; 100W



- Material: stop metali niekorodujących
- Material klosza: szkło
- Material: non-corrosive metals alloy
- Lampshade material: glass

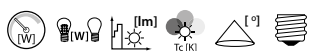

GLH/CL 28W E27	18450	5905339184504	28	37	370	2700	360	E27
GLH/CL 42W E27	18451	5905339184511	42	55	624	2700	360	E27
GLH/CL 52W E27	18452	5905339184528	52	68	815	2700	360	E27
GLH/CL 70W E27	18453	5905339184535	70	91	1172	2700	360	E27
GLH/CL 100W E27	18454	5905339184542	100	129	1800	2800	360	E27

[V]	[Hz]	[h]	[h]	[h]	[Ra]	[C]	CE	EAC
220-240 AC	50/60	2000	≥8000	≥95	C			

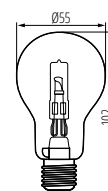

GLH/CL 28W; 42W; 52W; 70W; 100W

Kanlux CDH

HALOGENOWE ŹRÓDŁO ŚWIATŁA ► HALIDE LIGHT SOURCE



CDH/CL 28W E14; 42W E14

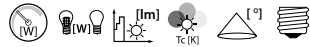

CDH/CL 28W E14	18440	5905339184405	28	37	370	2700	360	E14
CDH/CL 42W E14	18441	5905339184412	42	55	624	2700	360	E14

[V]	[Hz]	[h]	[lm]	[°]	[Ra]	[C]	CE	ERC
220-240 AC	50/60	2000	≥8000	≥95	C			



Materiał: stop metali niekorodujących
Materiał klosza: szkło
Material: non-corrosive metals alloy
Lampshade material: glass

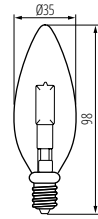

CDH/CL 28W E14; 42W E14

Kanlux MGH

HALOGENOWE ŹRÓDŁO ŚWIATŁA ► HALIDE LIGHT SOURCE



MGH/CL 28W E27; 42W E27



MGH/CL 28W E14; 42W E14

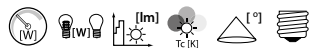

MGH/CL 28W E27	24610	5905339246103	28	37	375	2800	360	E27
MGH/CL 28W E14	24611	5905339246110	28	37	375	2800	360	E14
MGH/CL 42W E27	24612	5905339246127	42	55	625	2800	360	E27
MGH/CL 42W E14	24613	5905339246134	42	55	625	2800	360	E14

[V]	[Hz]	[h]	[lm]	[°]	[Ra]	[C]	CE	ERC
220-240 AC	50/60	2000	≥8000	≥95	C			



Materiał: stop metali niekorodujących
Materiał klosza: szkło
Material: non-corrosive metals alloy
Lampshade material: glass

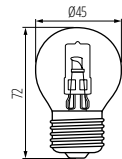

MGH/CL 28W E27; 42W E27

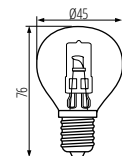

MGH/CL 28W E14; 42W E14

Kanlux

G9 STAR

HALOGENOWE ŹRÓDŁO ŚWIATŁA ► HALIDE LIGHT SOURCE



G9-20W; 33W; 48W; 60W STAR



Kanlux G9 STAR to żarówka halogenowa z trzonkiem G9.

Materiał: stop metali niekorodujących
Materiał klosza: szkło

Kanlux G9 STAR is a halogen bulb with G9 light bulb base.

Material: non-corrosive metals alloy
Lampshade material: glass

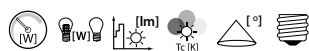

Model	Code	W [W]	lm [lm]	lm [lm]	lm [lm]	lm [lm]	lm [lm]	lm [lm]
G9-20W STAR	18420	5905339184207	20	26	235	2700	360	G9
G9-33W STAR	18421	5905339184214	33	43	460	2700	360	G9
G9-48W STAR	18422	5905339184221	48	63	740	2700	360	G9
G9-60W STAR	18423	5905339184238	60	78	975	2700	360	G9

[V]	[Hz]	[h]	[h]	[h]	[h]	[h]	[h]	[h]	[h]	[h]	[h]
220-240 AC	50/60	2000	≥8000	≥95	CE	ERL					

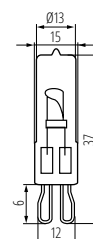

G9-20W; 33W; 48W; 60W STAR



Kanlux JC to halogenowa źródła światła z trzonkiem G4 i GY6.35.

Materiał klosza: szkło

Kanlux JC is a halogen light source with G4 and GY6.35 light bulb base.

Lampshade material: glass

JC-5W G4; 10W G4; 10W4/EK BASIC; 20W G4; 20W4/EK BASIC; 35W G4; 35W4/EK BASIC;



JC-5W G4; 10W G4; 10W4/EK BASIC; 20W G4; 20W4/EK BASIC; 35W G4; 35W4/EK BASIC;

JC-20W GY6.35; 35W GY6.35; 50W GY6.35



Model	Power [W]	Part No.	Life [h]	Beam Angle [lm]	Temp. [K]	Base	Dim.
JC-5W G4	10720	5905339107206	5	60	2700	G4	B
JC-10W G4	10722	5905339107220	10	120	2700	G4	C
JC-10W4/EK BASIC	10432	5905339104328	10	96	2700	G4	C
JC-20W G4	10724	5905339107244	20	330	2700	G4	C
JC-20W4/EK BASIC	10433	5905339104335	20	280	2700	G4	C
JC-35W G4	10726	5905339107268	35	600	2700	G4	C
JC-35W4/EK BASIC	10434	5905339104342	35	540	2700	G4	C
JC-20W GY6.35	10730	5905339107305	20	330	2700	GY6.35	C
JC-35W GY6.35	10732	5905339107329	35	600	2700	GY6.35	C
JC-50W GY6.35	10734	5905339107343	50	950	2700	GY6.35	C



JC-5W G4; 10W G4; 10W4/EK BASIC; 20W G4; 20W4/EK BASIC; 35W G4; 35W4/EK BASIC;



JC-20W GY6.35; 35W GY6.35; 50W GY6.35



J-1000W 189MM



J-1000W 189MM	10418	5905339104182	1000	1063	16000	2700	R7s	D
J-1500W 254MM	10419	5905339104199	1500	2060	31000	2700	R7s	C

[V]	[Hz]	[h]	≥8000	Hg	CE	EAC
220-240 AC	50/60	2000				

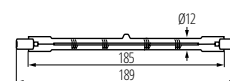

J-1000W 189MM

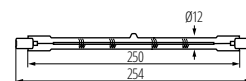

J-1500W 254MM



J-80W 78MM STAR

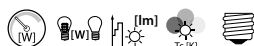

J-80W 78MM STAR	08490	5905339084903	80	100	1380	2700	R7s
J-120W 78MM STAR	08491	5905339084910	120	150	2220	2700	R7s
J-120W 118MM STAR	08500	5905339085009	120	150	2220	2700	R7s
J-160W 118MM STAR	08501	5905339085016	160	200	3100	2700	R7s
J-230W 118MM STAR	08502	5905339085023	230	300	4650	2700	R7s
J-400W 118MM STAR	08503	5905339085030	400	500	8550	2700	R7s

[V]	[Hz]	[h]	≥8000	Hg	CE	EAC
220-240 AC	50/60	2000				

Projektowe żarówki halogenowe, przeznaczone są do lamp i halopaków na gwint R7s. Dostępne moce to od 1000W aż do 1500W. Przeznaczone są do pracy w poziomie.

przeznaczone do pracy w poziomie, dopuszczalny odchył pozycji pracy +/-4°
Materiał klosza: szkło

The designed halogen bulbs are intended for lamps and halopaks with R7s thread. Available power from 1000W to 1500W. They are meant for horizontal work.

designed for horizontal operation, allowable deflection of working position +/-4°
Lampshade material: glass

Projektowe żarówki halogenowe, przeznaczone są do lamp i halopaków na gwint R7s. Dostępne moce to od 80W aż do 400W. Przeznaczone są do pracy w poziomie.

strumień świetlny większy średnio o 23%, przy zużyciu prądu mniejszym o 20% (w porównaniu z halogenem w klasie F)
przeznaczone do pracy w poziomie, dopuszczalny odchył pozycji pracy +/-4°
Materiał klosza: szkło

The designed halogen bulbs are intended for lamps and halopaks with R7s thread. Available power from 80W to 400W. They are meant for horizontal work.

23% more light flux by 20% lower power consumption (compared to F class halogen)
designed for horizontal operation, allowable deflection of working position +/-4°
Lampshade material: glass

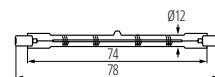

J-80W; 120W 78MM STAR

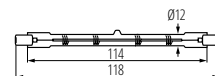

J-120W; 160W; 230W; 400W 118MM STAR

T2U

NIEINTEGROWANA ŚWIETŁÓWKA KOMPAKTOWA
▶ NON-INTEGRATED COMPACT FLUORESCENT TUBE



T2U-26W/4P 4000K



T2U-26W/K



T2U-18W/4P 4000K	08963	5905339089632	18	1206	4000	G24q	A	10000
T2U-26W/4P 4000K	08961	5905339089618	26	1716	4000	G24q	A	10000
T2U-18W/K	10661	5905339106612	18	1200	4000	G24d	B	8000
T2U-26W/K	10662	5905339106629	26	1716	4000	G24d	B	8000

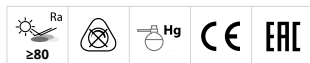

Kanlux T2U to niezintegrowane świetłówki kompaktowe o wysokiej trwałości (10000 h). Ich wysokie strumienie świetlne przy niskim poborze mocy czynią z nich energooszczędne rozwiązanie oświetleniowe dla opraw z trzonkiem G24q.

Material: szkło

Kanlux T2U are non-integrated compact fluorescent lamps with high durability (10000 h). Their high light streams with low consumption of power make them an energy-saving lighting solution for holders with G24q light bulb base.

Material: glass

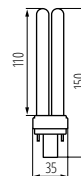

T2U-18W/4P 4000K
T2U-18W/K

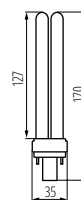

T2U-26W/4P 4000K
T2U-26W/K

T1U

NIEINTEGROWANA ŚWIETŁÓWKA KOMPAKTOWA
▶ NON-INTEGRATED COMPACT FLUORESCENT TUBE



T1U-9W/K, T1U 11W/K



T1U-9W/K	10671	5905339106711	9	603	4000	G23		
T1U-11W/K	10672	5905339106728	11	902	4000	G23		

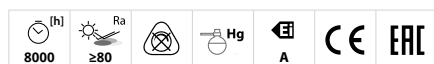

Kanlux T1U to niezintegrowane świetłówki kompaktowe o wysokiej trwałości (8000 h). Ich wysokie strumienie świetlne przy niskim poborze mocy czynią z nich energooszczędne rozwiązanie oświetleniowe dla opraw z trzonkiem G23.

Material: szkło

Kanlux T1U are non-integrated compact fluorescent lamps with high durability (8000 h). Their high light streams with low consumption of power make them an energy-saving lighting solution for holders with G23 light bulb base.

Material: glass

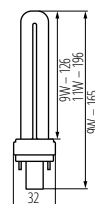

T1U-9W/K; T1U-11W/K

Kanlux

DD

KOMPAKTOWA ŚWIETŁÓWKA WTYKOWA ► COMPACT PLUG FLUORESCENT LAMP



DD 16W/4P; 21W/4P



DD 16W/4P; 21W/4P



DD 28W/4P; 38W/4P



Kanlux DD to rodzina świetlówek kompaktowych na trzonku GR10q. Ich wysokie strumienie świetlne przy niskim poborze mocy czynią z nich energooszczędne rozwiązanie oświetleniowe dla opraw z tego typu trzonkiem.

Materiał: szkło

Kanlux DD is a family of compact fluorescent lamps with GR10q light bulb base. Their high light streams with low consumption of power make them an energy-saving lighting solution for holders with this type of the light bulb base.

Materiał: glass

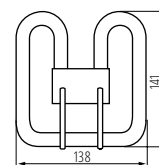

DD 16W/4P; 21W/4P

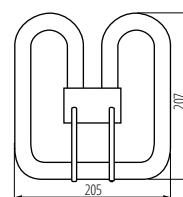

DD 28W/4P; 38W/4P

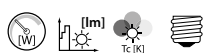

Model	Code	Part No.	Power (W)	Luminous Flux (lm)	Color Temp (K)	Base
DD-16W/4P 3500K	12660	5905339126603	16	1056	3500	GR10q
DD-21W/4P 3500K	12661	5905339126610	21	1344	3500	GR10q
DD-28W/4P 3500K	12662	5905339126627	28	2044	3500	GR10q
DD-38W/4P 3500K	12663	5905339126634	38	2698	3500	GR10q

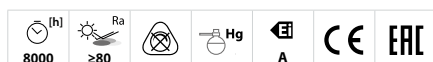



T5-8W; 13W; 14W

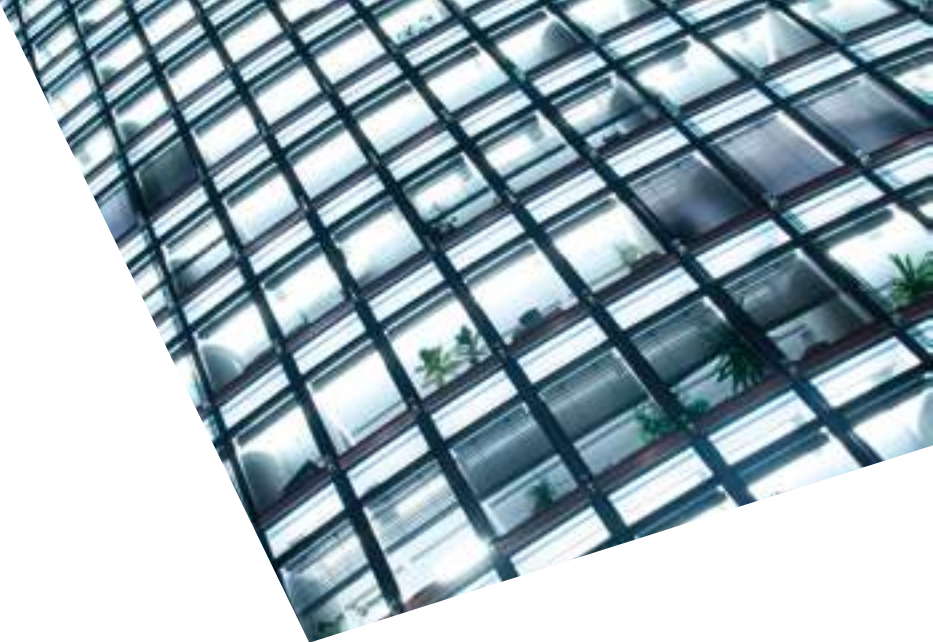

Kanlux T5 to jedno i trójpasemowe świetłóWki liniowe. Niskie zużycie energii i długi czas pracy (10.000H) to niewątpliwe zalety tych lamp.

T5-8W, T5-13W: świetłóWki jednopasmowe, pozostałe modele to świetłóWki trójpasemowe
Material: szkło

Kanlux T5 are oneband and triband linear fluorescent lamps. Low consumption of energy and long working time (10.000H) are indisputable advantages of these lamps.

T5-8W, T5-13W: fluorescent lamps, other models are tri-band fluorescent
Material: glass



T5-8W 4000K/65	12715	5905339127150	8	688	4000	G5	≥65	10000
T5-13W 4000K/65	12716	5905339127167	13	1118	4000	G5	≥65	10000
T5-14W 4000K/82	12717	5905339127174	14	1204	4000	G5	≥82	20000

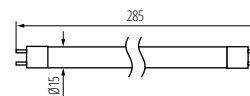

T5-8W 4000K/65

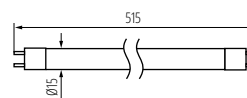

T5-13W 4000K/65

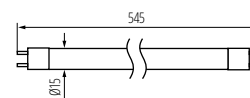

T5-14W 4000K/82

T8

ŚWIETŁÓWKA LINIOWA ► LINEAR FLUORESCENT LAMP



T8 18W; 36W; 58W



Kanlux T8 to trójpasemowe świetłóWKi liniowe. Niskie zużycie energii i długi czas pracy (15.000H) to niewątpliwe zalety tych lamp.

Materiał: szkło

Kanlux T8 are triband linear fluorescent lamps. Low consumption of energy and long working time (15.000H) are indisputable advantages of these lamps.

Materiał: glass



T8 18W/830 WW	19920	5905339199201	18	1350	3000	G13	A
T8 18W/840 NW	19921	5905339199218	18	1350	4000	G13	A
T8 18W/865 CW	19922	5905339199225	18	1250	6500	G13	A
T8 36W/840 NW	19924	5905339199249	36	3350	4000	G13	A+
T8 36W/865 CW	19925	5905339199256	36	3050	6500	G13	A
T8 58W/830 WW	19926	5905339199263	58	5250	3000	G13	A+
T8 58W/840 NW	19927	5905339199270	58	5250	4000	G13	A+
T8 58W/865 CW	19928	5905339199287	58	5000	6500	G13	A

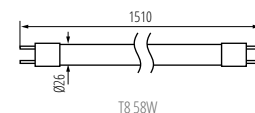
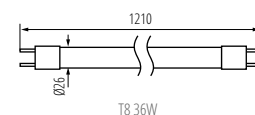
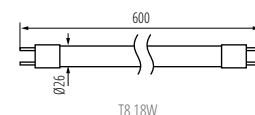

Kanlux MHE

LAMPA METALOHALOGENKOWA ► METAL-HALIDE LAMP



MHE-250W/4200K

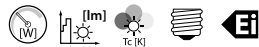

MHE-250W/4200K	12755	5905339127556	250	23000	4200	E40	A
MHE-400W/4200K	12756	5905339127563	400	35000	4200	E40	A+



Lampy metalohalogenkowe Kanlux MHE pracują ze statecznikami do wysokoprężnych lamp sodowych/ lamp metalohalogenkowych i zapłonnikami do lamp metalohalogenkowych.

Materiał: szkło

Kanlux MHE metal-halide lamps work with stabilizers for high-pressure sodium lamps/metal-halide lamps and igniters for metal-halide lamps.

Material: glass

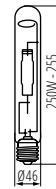

MHE-250W/4200K

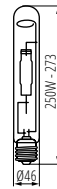

MHE-400W/4200K





Kanlux



OPRAWY DOMOWE I DEKORACYJNE
DOMESTIC AND DECORATIVE FIXTURES

**Każdego dnia gościmy w Twoim domu.
Ty dbasz o to by Twoje wnętrza były piękne,
a my dbamy o to by nasze produkty
były dopracowane w każdym detalu.**

We are present in your house every day.
You take care of the beauty of your interiors,
and we take care of refining our products
down to in the finest detail.



*dane fotometryczne znajdziesz na:
photometric data you can find on:*

► [kanlux.com](https://www.kanlux.com)

Kanlux ETISSA

LAMPKA WISZĄCA ► PENDANT LAMP



ETISSA D20 GR



ETISSA D20 GR | 27000 | 5905339270009 | max 40 | szary | grey

				IP		
220-240 AC	50/60	E27		20		5÷25
		0,75÷2,5	0,5m			



Kanlux ETISSA to lampy wiszące, które współpracują ze wszystkimi źródłami światła o trzonku E27. Oprawy wykonane są z masy betonowej. Stylistycznie są to produkty utrzymane w surowym, loftowym klimacie, doskonale pasujące do nowoczesnych, minimalistycznych wnętrz. Ich powłoka jest porowata, co jest charakterystyczne dla powierzchni betonowych.

Materiał klosza: beton

Kanlux ETISSA are hanging lamps which cooperate with all sources of light with E27 light bulb base. Holders are made of concrete mass. In stylistic terms, they are products in a severe, loft-like climate, perfectly matching modern, minimalist interiors. Their coating is porous, which is characteristic of concrete surfaces.

Lampshade material: concrete

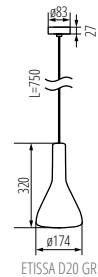

ETISSA D20 GR

Kanlux OGIVA

LAMPKA WISZĄCA ► PENDANT LAMP



OGIVA D35 GR



OGIVA D35 GR | 27001 | 5905339270016 | max 40 | szary | grey

				IP		
220-240 AC	50/60	E27		20		5÷25
		0,75÷2,5	0,5m			



Kanlux OGIVA to lampy wiszące, które współpracują ze wszystkimi źródłami światła o trzonku E27. Oprawy wykonane są z masy betonowej w kolorze naturalnym (szarym). Stylistycznie są to produkty utrzymane w surowym, loftowym stylu, doskonale pasujące do nowoczesnych, minimalistycznych wnętrz. Ich powłoka jest porowata, co jest charakterystyczne dla powierzchni betonowych. Lampy wyprodukowane zostały w Polsce.

Materiał klosza: beton

Kanlux OGIVA are hanging lamps co-operating with all light sources with E27 light bulb base. Luminaires are made of concrete mass of natural colour (grey). In terms of style, the products have austere, loft style, perfectly matching modern, minimalist interiors. Their coating is porous, which is characteristic of concrete surfaces. The lamps are manufactured in Poland.

Lampshade material: concrete

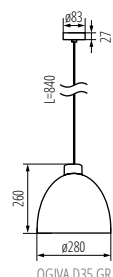

OGIVA D35 GR

Kanlux

GRAVME

LAMPA WISZĄCA ► PENDANT LAMP



GRAVME C



GRAVME O



Kanlux GRAVME to lampy wiszące, które ujmują swym wyglądem i posiadają niezwykły charakter. Z pozoru prosta forma zestawia dwa materiały beton i ceramikę. Po włączeniu światła ceramika nabiera miodowej tonacji nadając przytulny klimat pomieszczenia.

Materiał klosza: beton

Kanlux GRAVME are hanging lamps which captivate with their appearance and have unusual character. Apparently, the simple form combines two materials: concrete and ceramics. After turning on light, the ceramics gets a honey tone creating a cosy climate of room.

Lampshade material: concrete



GRAVME O G/HY	24280	5905339242808	max 20	szary mat grey matte
GRAVME C G/HY	24281	5905339242815	max 20	szary mat grey matte

220-240 AC	50/60	E27		IP 20		5+25	
1+2,5	0,5m	1.4					

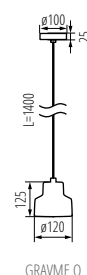

GRAVME O

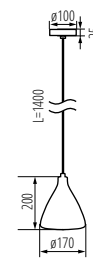

GRAVME C

Kanlux ALGO

LAMPA WISZĄCA ► PENDANT LAMP



ALGO GU10 PL-B



ALGO GU10 PO-B



ALGO GU10 PL-W



ALGO GU10 PO-W



ALGO GU10 PL-B	27036	5905339270368	max 40	czarny black
ALGO GU10 PL-W	27038	5905339270382	max 40	biały white
ALGO GU10 PO-B	27039	5905339270399	max 40	czarny black
ALGO GU10 PO-W	27041	5905339270412	max 40	biały white

[V] 220-240 AC	[Hz] 50/60	[Lamp] PAR16	[Socket] GU10	[Grounding] ⊕	[IP] 20	[Temp] 5+25
					CE	ERL
		0,75x2,5	0,5m			



Kanlux ALGO to seria opraw wiszących, które mają kształt walca lub sześcianu. Pomimo swoich niewielkich rozmiarów efektywnie prezentują się we wnętrzach domowych, czy użyteczności publicznej. Dzięki regulowanemu sznurowi o długości do 65 cm możemy dopasować lampy Kanlux ALGO do wysokości pomieszczenia. Sami dobierzemy do oprawy pasujące nam, wymienne źródło światła (trzonek GU10).

Materiał obudowy: stop aluminium

Kanlux ALGO is a series of hanging holders in the shape of a cylinder or cube. Despite their small dimensions, they look effective in home interiors or public interiors. Thanks to the adjustable rope up to 65 cm long, you can adapt the Kanlux ALGO lamps to height of a room. You can choose the replaceable light source (GU10 light bulb base) suiting you to the holder on your own.

Enclosure material: aluminum alloy



ALGO GU10 PL

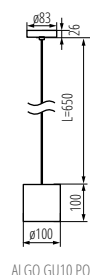

ALGO GU10 PO

Kanlux

ROLSA

LAMPA WISZĄCA LED ► LED PENDANT LAMP



ROLSA LED S-W



ROLSA LED S-W | 24393 | 5905339243935 | 4 | biały | white | 180 | 65 | 3000

[V]	[Hz]		(h)	Ra	SMD			IP
220-240 AC	50/60	≥20000	30000	≥80				20
	5+25			1+2,5	0,5m		CE	ERC



Cechą charakterystyczną tej lampy jest nietypowy klosz w kształcie tuby. Kanlux ROLSA świetnie wyglądają pojedynczo jak i w grupie. Można zawiesić je na różnych wysokościach, tworząc w ten sposób niepowtarzalną kompozycję świetlną. Idealnie komponują się z nowoczesnymi, minimalistycznymi przestrzeniami.

Materiał obudowy: stop aluminium
Materiał klosza: stop aluminium

The untypical lampshade in the shape of a tube is a characteristic feature of this lamp. Kanlux ROLSA lamps look perfect on a single basis and in a group. You can hang them at different heights, creating a unique light composition in this way. They ideally fit into modern, minimalist spaces.

Enclosure material: aluminum alloy
Lampshade material: aluminum alloy



ROLSA LED S

Kanlux

CORDES

LAMPA WISZĄCA ► PENDANT LAMP



CORDES



CORDES | 25530 | 5905339255303 | max 60 | biały | white

[V]	[Hz]			IP		5+25	
220-240 AC	50/60	E27		20			
	0,5+1,5	0,5m	1,4		CE	ERC	



Kanlux CORDES to niebanalna kształtem lampą do zawieszania. Dużym atutem tej oprawy jest materiał z jakiego został wykonany klosz, jest to folia polipropylenowa, która podlega recyklingowi, a przede wszystkim jest niezwykle łatwa w utrzymaniu czystości.

Materiał obudowy: tworzywo sztuczne
Materiał klosza: folia polipropylenowa

Kanlux CORDES is a lamp for suspension in original shape. The material of which the lampshade was made i.e. polypropylene foil which is subject to recycling and, mainly, can extremely easily be cleaned is a big asset of this holder.

Enclosure material: plastic
Lampshade material: Polypropylene film

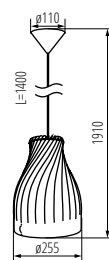

CORDES

Kanlux CYDEA

LAMPA WISZĄCA ► PENDANT LAMP



Kanlux CYDEA to oprawy, które można zastosować jako oświetlenie główne lub uzupełniające, gdyż na tę rodzinę składa się kilka typów lamp - od stojących po wiszące. Dużym atutem opraw Kanlux CYDEA jest materiał z jakiego zostały wykonane, jest to folia polipropylenowa, która podlega recyklingowi, a przede wszystkim jest niezwykle łatwa w utrzymaniu czystości.

Materiał obudowy: tworzywo sztuczne

Materiał klosza: folia polipropylenowa

Kanlux CYDEA are holders which can be used as main or additional lighting because this family comprises several types of lamps - from standing to hanging. The material of which it was made i.e. polypropylene foil which is subject to recycling and, mainly, can easily be cleaned is a big asset of Kanlux CYDEA holders.

Enclosure material: plastic

Lampshade material: Polypropylene film



CYDEA P



CYDEA P | **25552** | 5905339255525 max 60 biały | white

[V] 220-240 AC	[Hz] 50/60	E27	IP 20	5+25	1.4	CE	ERL	Kanlux
0,5+1,5	0,5m	1.4						

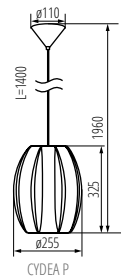

Kanlux TOKIA

LAMPA WISZĄCA ► PENDANT LAMP



TOKIA P-R

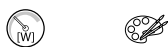

TOKIA P-W/B | **25521** | 5905339255211 max 60 biały / czarny | white / black
 TOKIA P-G | **25522** | 5905339255228 max 60 zielony | green
 TOKIA P-R | **25523** | 5905339255235 max 60 czerwony | red

[V] 220-240 AC	[Hz] 50/60	E27	IP 20	5+25	1.7	CE	ERL	Kanlux
0,5+1,5	0,5m	1.7						



Kanlux TOKIA to minimalistyczne lampy wiszące składające się z ceramicznej oprawki i sznura, który dostępny jest w kilku wariantach kolorystycznych. Idealne do stworzenia świetlnych aranżacji dla miłośników surowych klimatów industrialnych, jak i stylizacji o lekkim zabarwieniu retro.

Materiał obudowy: tworzywo sztuczne

Materiał klosza: ceramika

Kanlux TOKIA are minimalistic hanging lamps consisting of a ceramic frame and rope which is available in several colour variants. Ideal for creating light arrangements for fans of severe industrial climates and stylizations with light retro tint.

Enclosure material: plastic

Lampshade material: ceramics



TOKIA

Kanlux LUNATI

OPRAWA SUFITOWA PUNKTOWA ► CEILING-MOUNTED SPOTLIGHT FITTING

NEW



LUNATI GU10 W



LUNATI GU10 W	29040	5905339290403	max 25	biały white
LUNATI GU10 B	29041	5905339290410	max 25	czarny black

[V]	[Hz]	GU10	IP	°C	⚡	⚡
220-240 AC	50/60	GU10	20	5+25		
0,75+1,5	0,5m	PAR16	CE	ERAC	Kanlux	



Kanlux LUNATI to eleganckie oprawy sufitowe. Dużym atutem jest ich wzornictwo, dolny akrylowy pierścień w połączeniu ze stopem aluminium to nietypowe połączenie materiałów dające bardzo ciekawy rozsył światła.

Materiał obudowy: stop aluminium

Kanlux LUNATI are elegant ceiling fixtures. Their design is a big advantage - the lower acrylic ring, in combination with aluminum alloy, creates an unusual combination of materials, resulting in a very-interesting form of light distribution.

Enclosure material: aluminum alloy

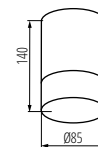

LUNATI GU10

Kanlux SANI IP44

OPRAWA SUFITOWA PUNKTOWA ► CEILING-MOUNTED SPOTLIGHT FITTING

NEW



SANI IP44 DSO-B



SANI IP44 DSO-B	29240	5905339292407	max 10	czarny black
SANI IP44 DSO-W	29241	5905339292414	max 10	biały white

[V]	[Hz]	GU10	IP	°C	⚡	⚡
220-240 AC	50/60	GU10	44	5+25		
0,75+1,5	0,5m	PAR16	CE	ERAC	Kanlux	



KANLUX SANI IP44 to oprawy natynkowe. Charakteryzują się prostą stylistyką i dostępnością w dwóch kolorach – białym i czarnym. Wysoka szczelność opraw (IP44) pozwala stosować je w pomieszczeniach, w których urządzenia elektryczne narażone są na podwyższoną wilgotność oraz ryzyko zalania wodą m.in. łazienka i kuchnia.

Materiał obudowy: stop aluminium

Materiał klosza: tworzywo sztuczne

KANLUX SANI IP44 are surface holders. They are characterized by simple stylistics and availability in two colours - white and black. High tightness of the holders (IP44) allows using them in rooms where electric devices are exposed to increased humidity and risk of flooding with water e.g. bathroom and kitchen.

Enclosure material: aluminum alloy

Lampshade material: plastic

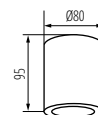

SANI IP44 DSO

Kanlux BORD

OPRAWA SUFITOWA PUNKTOWA ► CEILING-MOUNTED SPOTLIGHT FITTING



BORD DLP-50-B



Kanlux BORD to popularne oprawy natynkowe. Charakteryzuje je ciekawy i wyrazisty kształt w formie walca. Kanlux BORD gwarantują wyjątkowe oświetlenie umożliwiające podkreślenie niektórych elementów wystroju pomieszczenia i stworzenie przyjemnego nastroju. Nowoczesny design a także elegancka prostota sprawiają, że oprawy te pasują zarówno do wnętrz mieszkalnych jak i komercyjnych.

Materiał obudowy: stop aluminium

Kanlux BORD are popular surface holders. They are characterized by an interesting and expressive shape in the form of a roller. Kanlux BORD guarantee exceptional lighting making it possible to emphasize some elements of decor in a room and create pleasant atmosphere. Modern design and elegant simplicity make these holders match both residential interiors and commercial interiors.

Enclosure material: aluminum alloy



BORD DLP-50-AL	22550	5905339225504	max 25	aluminium szczotkowane brushed aluminium
BORD DLP-50-W	22551	5905339225511	max 25	biały mat matte white
BORD DLP-50-B	22552	5905339225528	max 25	czarny mat black matt
BORD DLP-250-AL	22553	5905339225535	2 x max 25	aluminium szczotkowane brushed aluminium
BORD DLP-250-W	22554	5905339225542	2 x max 25	biały mat matte white
BORD DLP-250-B	22555	5905339225559	2 x max 25	czarny mat black matt
BORD DLP-350-W	25800	5905339258007	3 x max 25	biały mat matte white
BORD DLP-350-AL	25802	5905339258021	3 x max 25	aluminium szczotkowane brushed aluminium

[V] 220-240 AC	[Hz] 50/60	[W] GU10	[IP] 20	[°C] 5÷25	[mm] 0,75÷1,5	[m] 0,5m	[PAR] PAR16	[CE]	[EAC]	[Energy Class] A+ A A B C D E
--------------------------	----------------------	--------------------	-------------------	---------------------	-------------------------	--------------------	-----------------------	-------------	--------------	---

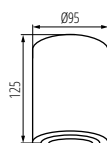

BORD DLP-50

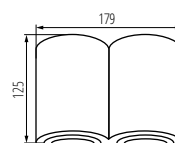

BORD DLP-250

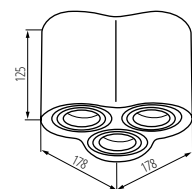

BORD DLP-350

Kanlux
BORD

OPRAWA SUFITOWA PUNKTOWA ► CEILING-MOUNTED SPOTLIGHT FITTING



BORD DLP-50-AL



BORD DLP-50-W



BORD DLP-50-B



BORD DLP-250-AL



BORD DLP-250-W



BORD DLP-250-B



BORD DLP-350-AL



BORD DLP-350-W



Kanlux GORD

OPRAWA SUFITOWA PUNKTOWA ► CEILING-MOUNTED SPOTLIGHT FITTING



GORD DLP 50-AL



GORD DLP 50-W



GORD DLP 50-B



GORD DLP 250-W



GORD DLP 250-B

GORD DLP 50-W	25470	5905339254702	max 25	biały mat matte white	
GORD DLP 50-B	25471	5905339254719	max 25	czarny mat black matt	
GORD DLP 50-AL	25472	5905339254726	max 25	aluminium szczotkowane brushed aluminium	
GORD DLP 250-W	25473	5905339254733	2 x max 25	biały mat matte white	
GORD DLP 250-B	25474	5905339254740	2 x max 25	czarny mat black matt	

				IP				
220-240 AC	50/60	GU10		20		5+25		
25	0,75÷1,5	0,5m		PAR16				

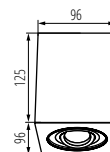

GORD DLP-50

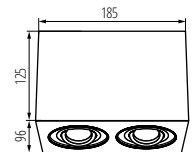

GORD DLP-250



Kanlux GORD to popularne oprawy natynkowe. Charakteryzuje je ciekawy i wyrazisty kształt w formie sześcianu. Kanlux GORD gwarantują wyjątkowe oświetlenie umożliwiające podkreślenie niektórych elementów wystroju pomieszczenia i stworzenie przyjemnego nastroju. Nowoczesny design a także elegancka prostota sprawiają, że oprawy te pasują zarówno do wnętrz mieszkalnych jak i komercyjnych.

Materiał obudowy: stop aluminium

Kanlux GORD are popular surface holders. They are characterized by an interesting and expressive shape in the form of a cube. Kanlux GORD guarantee exceptional lighting making it possible to emphasize some elements of decor in a room and create pleasant atmosphere. Modern design and elegant simplicity make these holders match both residential interiors and commercial interiors.

Enclosure material: aluminum alloy

Kanlux
DUCE

OPRAWA SUFITOWA PUNKTOWA ▶ CEILING-MOUNTED SPOTLIGHT FITTING



DUCE AL-DTL50



DUCE AL-DT050



Kanlux DUCE to nowoczesny design i prostota konstrukcji. Świetnie sprawdzi się jako oświetlenie podstawowe lub uzupełniające, zarówno we wnętrzach prywatnych, jak i przestrzeniach użyteczności publicznej. Jest polecana tam gdzie dyskretnym oświetleniem, chcemy zaakcentować ciekawą aranżację. Możliwość regulacji wychylenia źródła światła o kąt 25°, pozwala kierować strumień świetlny w pożądane miejsce lub punkt.

Materiał obudowy: stop aluminium

Kanlux DUCE is a modern design and simplicity of construction. It will work well as basic or additional lighting both in private interiors and public spaces. It is recommended in places where you want to emphasize an interesting arrangement by means of discrete lighting. A possibility of adjusting a deflection of light source by the angle of 25° allows to direct the light stream into a desirable place or point.

Enclosure material: aluminum alloy



DUCE AL-DTL50	19950	5905339199508	max 25	aluminium szczotkowane brushed aluminium
DUCE AL-DT050	19951	5905339199515	max 25	aluminium szczotkowane brushed aluminium

[V] 220-240 AC	[Hz] 50/60	[GU] GU10	[IP] 20	[°C] 5+25	[m] 0,5m	[PAR] PAR16	[E] E	[A] A	[B] B	[C] C	[D] D	[E] E
--------------------------	----------------------	---------------------	-------------------	---------------------	--------------------	-----------------------	-----------------	-----------------	-----------------	-----------------	-----------------	-----------------

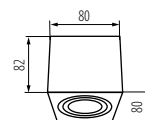

DUCE AL-DTL

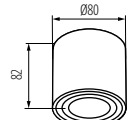

DUCE AL-DT0

Kanlux ALGO

OPRAWA SUFITOWA PUNKTOWA ► CEILING-MOUNTED SPOTLIGHT FITTING



ALGO GU10 CL-B



ALGO GU10 CL-W



ALGO GU10 CO-B



ALGO GU10 CO-W



Kanlux ALGO to seria opraw, które mają kształt walca lub sześcianu. Pomimo swoich niewielkich rozmiarów efektywnie prezentują się we wnętrzach domowych, czy użyteczności publicznej. Wszystkie modele wykonane są z aluminium, pasują do nich źródła światła o trzonku GU10.

Materiał obudowy: stop aluminium

Kanlux ALGO is a series of holders in the shape of a cylinder or cube. Despite their small dimensions, they look effective in home interiors or public interiors. All models are made of aluminium and light sources with GU10 light bulb base match them.

Enclosure material: aluminum alloy



ALGO GU10 CL-B	27030	5905339270306	max 40	czarny black
ALGO GU10 CL-W	27032	5905339270320	max 40	biały white
ALGO GU10 CO-B	27033	5905339270337	max 40	czarny black
ALGO GU10 CO-W	27035	5905339270351	max 40	biały white

[V] 220-240 AC	[Hz] 50/60	GU10	IP 20	5+25	5+25	5+25
1+2,5	0,5m	PAR16				

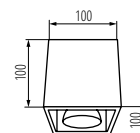

ALGO GU10 CL

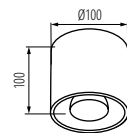

ALGO GU10 CO

RITI

OPRAWA SUFITOWA PUNKTOWA ► CEILING-MOUNTED SPOTLIGHT FITTING



RITI GU10 W/G



RITI GU10 W/G



RITI GU10 B/G



RITI REF W



RITI REF B



RITI REF SR



RITI GU10 W/G	27570	5905339275707	max 25	biały / złoty white / gold
RITI GU10 B/G	27571	5905339275714	max 25	czarny / złoty black/gold

220-240 AC	50/60	GU10	IP 20	20		5+25	
0,75+1,5		0,5m	PAR16				A A A B C D E

AKCESORIA ► ACCESSORIES

RITI REF B	27572	5905339275721	Zamienny odbłyśnik RITI REF B czarny / Replacement reflector RITI REF B black
RITI REF SR	27574	5905339275745	Zamienny odbłyśnik RITI REF SR srebrny / Replacement reflector RITI REF SR silver
RITI REF W	27573	5905339275738	Zamienny odbłyśnik RITI REF W biały / Replacement reflector RITI REF W white



Kanlux RITI wykonany jest z aluminium, piaskowana struktura powierzchni jest lakierowana na kolor matowy, natomiast odbłyśnik jest pokryty warstwą złoto-miedzianego lakieru z błyszczącym pigmentem. Seria Kanlux RITI cechuje się dobrą jakością wykonania, nowoczesnym wzornictwem. Z powodzeniem możemy zastosować ją jako oświetlenie samodzielne lub zestawiając ze sobą kilka opraw.

Materiał obudowy: stop aluminium

The Kanlux RITI is in aluminium, the sandblasted surface structure is matte-lacquered, and the reflector is covered with a layer of gold-copper lacquer with a shiny pigment. The Kanlux RITI series is characterised by good-quality workmanship and modern design. It can be successfully used as a stand-alone lighting system, or as a combination of several fixtures.

Enclosure material: aluminum alloy

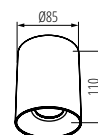

RITI GU10

Kanlux TOLEO

OPRAWA SUFITOWA PUNKTOWA ► CEILING-MOUNTED SPOTLIGHT FITTING



TOLEO DTL50-W



Seria Kanlux TOLEO to nowoczesne, podwieszane oprawy sufitowe. Minimalistyczny design, aluminiowa obudowa oraz modna kolorystyka, czynią je bardzo ciekawym elementem wykończenia wnętrza. Oprawy Kanlux TOLEO dzięki swoim unikatowym, opływowym kształtom, uniwersalnej kolorystyce oraz możliwości samodzielnego wyboru barwy światła idealnie pasują zarówno do wnętrz mieszkalnych jak i powierzchni komercyjnych.

Materiał obudowy: stop aluminium

Kanlux TOLEO series consists of modern, suspended ceiling holders. Minimalistic design, aluminium casing and fashionable colour scheme make them a very interesting element of interior finishing touch. Kanlux TOLEO holders, thanks to their unique, streamlined shapes, universal colour scheme and a possibility of selecting light colour on your own ideally fit into both residential interiors and commercial spaces.

Enclosure material: aluminum alloy



TOLEO DT050-B	26110	5905339261106	max 25	czarny mat black matt
TOLEO DT050-W	26111	5905339261113	max 25	biały mat matte white
TOLEO DTL50-B	26113	5905339261137	max 25	czarny mat black matt
TOLEO DTL50-W	26114	5905339261144	max 25	biały mat matte white
TOLEO DT0250-W	26117	5905339261175	2 x max 25	biały mat matte white
TOLEO DTL250-B	26119	5905339261199	2 x max 25	czarny mat black matt
TOLEO DTL250-W	26120	5905339261205	2 x max 25	biały mat matte white

[V] 220-240 AC	[Hz] 50/60	GU10	IP 20	5-25 °C	30/30	0,75+1,5	0,5m	PAR16	CE	ERL	Kanlux
											A+ A B C D E

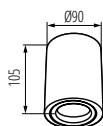

TOLEO DT050

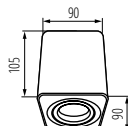

TOLEO DTL50

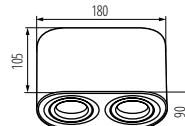

TOLEO DT0250

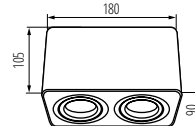

TOLEO DTL250

Kanlux

TOLEO

OPRAWA SUFITOWA PUNKTOWA ▶ CEILING-MOUNTED SPOTLIGHT FITTING



TOLEO DT050-W



TOLEO DT050-W



TOLEO DTL50-W



TOLEO DTL50-W



TOLEO DT0250-W



TOLEO DTL250-W



TOLEO DTL250-B



Kanlux STOBI

OPRAWA SUFITOWA PUNKTOWA ► CEILING-MOUNTED SPOTLIGHT FITTING



STOBI DLP 50-B



Kanlux STOBI to linia opraw sufitowych z wymiennym źródłem światła. Wykonane są z aluminium i mają możliwość pełnej regulacji kąta padania światła. Wysokiej jakości wykończenie (powierzchnia matowa, piaskowana) i prosta stylistyka sprawiają, że oprawy doskonale nadają się do wyposażenia pomieszczeń domowych, ale również biur i apartamentów.

Materiał obudowy: stop aluminium

The Kanlux STOBI is the line of ceiling fixtures, with a replaceable light source. They are in aluminium with a fully adjustable light-beam angle. The high-quality finish (matte, sanded surface), and simple style, make the fixtures perfect for rooms at home, and also for offices and apartments.

Enclosure material: aluminum alloy



STOBI DLP 50-B	26830	5905339268303	max 25	czarny black
STOBI DLP 50-W	26831	5905339268310	max 25	biały white
STOBI DLP 250-B	26832	5905339268327	2 x max 25	czarny black
STOBI DLP 250-W	26833	5905339268334	2 x max 25	biały white
STOBI DLP 350-B	26834	5905339268341	3 x max 25	czarny black
STOBI DLP 350-W	26835	5905339268358	3 x max 25	biały white
STOBI DLP 450-B	26836	5905339268365	4 x max 25	czarny black
STOBI DLP 450-W	26837	5905339268372	4 x max 25	biały white

[V] 220-240 AC	[Hz] 50/60	GU10	IP 20	°C 5+25	CE	ERAC	Kanlux
65/45	8/8	1+2,5	0,75-1,5	0,5m	PAR16		

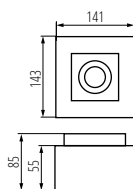

STOBI DLP 50

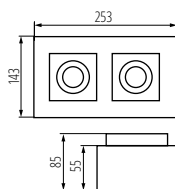

STOBI DLP 250

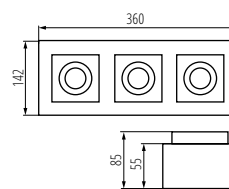

STOBI DLP 350

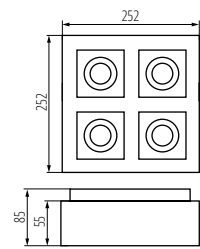

STOBI DLP 450

Kanlux
STOBI

OPRAWA SUFITOWA PUNKTOWA ▶ CEILING-MOUNTED SPOTLIGHT FITTING



STOBI DLP 50-B



STOBI DLP 50-W



STOBI DLP 250-B



STOBI DLP 250-W



STOBI DLP 350-B



STOBI DLP 350-W



STOBI DLP 450-B



STOBI DLP 450-W



Kanlux TORIM

OPRAWA SUFITOWA PUNKTOWA ▶ CEILING-MOUNTED SPOTLIGHT FITTING



TORIM DLP-50 B-W



TORIM DLP-50 W-B



TORIM DLP-250 W-B



TORIM DLP-250 B-W



Kanlux TORIM to zestawienie bieli i czerni, do którego dodaliśmy proste geometryczne kształty. Kanlux TORIM to sufitowe oprawy punktowe wykonane z blachy stalowej zaprojektowane z myślą o wnętrzach nowoczesnych. Do opraw Kanlux TORIM pasują żarówki z trzonkiem GU10, a sam kierunek padania światła możemy regulować w zakresie 15 stopni.

Materiał obudowy: stal

The Kanlux TORIM is a combination of black and white, with the addition of simple geometric shapes. The Kanlux TORIM is a ceiling-point fixture in steel sheet, designed for modern interiors. The Kanlux TORIM fixtures are compatible with GU10 cap bulbs, and the light-beam angle can be adjusted within the range of 15°.

Enclosure material: steel



TORIM DLP-50 W-B	28460	5905339284600	max 35	biały / czarny white / black
TORIM DLP-50 B-W	28461	5905339284617	max 35	czarny / biały black/white
TORIM DLP-250 W-B	28462	5905339284624	2 x max 35	biały / czarny white / black
TORIM DLP-250 B-W	28463	5905339284631	2 x max 35	czarny / biały black/white

[V] 220-240 AC	[Hz] 50/60	GU10	IP 20	5+25	ERC
15	1+2,5	0,5m	PAR16	CE	ERC

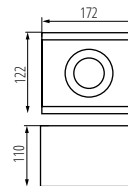

TORIM DLP-50

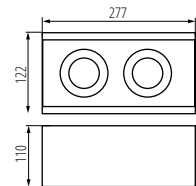

TORIM DLP-250

Kanlux MERSA

PLAFONIERA ► CEILING LIGHT FITTING



MERSA 300-B/M



MERSA 300-W/M



MERSA 380-W/M



MERSA 300-B/M



MERSA 380-B/M

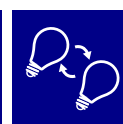

Starannie wykonane, drewniane oprawy Kanlux MERSA otwierają możliwość ciekawej aranżacji pomieszczeń. Efektowna obudowa w połączeniu z satynowym szkłem, które zapewnia równomierne rozproszenie światła, nada niepowtarzalnego charakteru każdemu wnętrzu.

Materiał obudowy: drewno

Materiał klosza: szkło

The carefully made wooden Kanlux MERSA fixtures create the possibility of an interesting room arrangement. Its impressive casing combined with satin glass, which ensures a uniform distribution of light, will give each interior a unique character.

Enclosure material: Wood

Lampshade material: glass



MERSA 300-W/M	25675	5905339256751	2 x max 60	E27	GLS/CFL/LED	biały mat matte white
MERSA 380-W/M	25678	5905339256782	3 x max 40	E27	GLS/CFL/LED	biały mat matte white
MERSA 300-B/M	29050	5905339290502	2 x max 60	E27	GLS/CFL/LED	czarny mat black matt
MERSA 380-B/M	29051	5905339290519	3 x max 40	E27	GLS/CFL/LED	czarny mat black matt

[V] 220-240 AC	[Hz] 50/60	IP 20	Dim 5+25	LED	CE	ERL	Kanlux
1+2,5	0,5m	CE	ERL	A A B C D E			

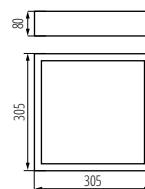

MERSA 300

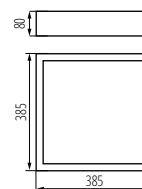

MERSA 380



JASMIN 270-WE

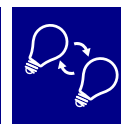

Originalne, a zarazem stylowe okrągłe oprawy Kanlux JASMIN cechują się nowoczesnym i atrakcyjnym designem. Obudowa plafoniera wykonana jest z drewna oraz szkła trawionego (satynowego), które zapewnia równomierne rozproszenie światła. Klasyczne połączenie drewna i szkła sprawia, że jest to bardzo uniwersalne rozwiązanie oświetleniowe.

Materiał obudowy: drewno
Materiał klosza: szkło

The original and at the same time stylish round holders - Kanlux JASMIN are characterized by modern and attractive design. The casing of the ceiling light fixture is made of wood and etched (satin) glass which ensures even dispersal of light. The classic combination of wood and glass makes it a very universal lighting solution.

Enclosure material: Wood
Lampshade material: glass



JASMIN 270-WE	23120	5905339231208	max 60	E27	GLS/CFL/LED	wenge
JASMIN 370-WE	23121	5905339231215	2 x max 60	E27	GLS/CFL/LED	wenge
JASMIN 470-WE	23122	5905339231222	3 x max 40	E27	GLS/CFL/LED	wenge
JASMIN 270-W	23123	5905339231239	max 60	E27	GLS/CFL/LED	dąb sonoma Sonoma oak
JASMIN 370-W	23124	5905339231246	2 x max 60	E27	GLS/CFL/LED	dąb sonoma Sonoma oak
JASMIN 470-W	23125	5905339231253	3 x max 40	E27	GLS/CFL/LED	dąb sonoma Sonoma oak
JASMIN 270-W/M	23126	5905339231260	max 60	E27	GLS/CFL/LED	biały mat matte white
JASMIN 370-W/M	23127	5905339231277	2 x max 60	E27	GLS/CFL/LED	biały mat matte white
JASMIN 470-W/M	23128	5905339231284	3 x max 40	E27	GLS/CFL/LED	biały mat matte white
JASMIN 470-A	23129	5905339231291	3 x max 40	E27	GLS/CFL/LED	antracyt anthracite
JASMIN 370-A	29200	5905339292001	2 x max 60	E27	GLS/CFL/LED	antracyt anthracite
JASMIN WE-W	23756	5905339237569	max 60	E27	GLS/CFL/LED	wenge
JASMIN W-W	23757	5905339237576	max 60	E27	GLS/CFL/LED	dąb sonoma Sonoma oak
JASMIN W/M-W	23758	5905339237583	max 60	E27	GLS/CFL/LED	biały mat matte white
JASMIN 470-W-H	23752	5905339237521	3 x max 40	E27	GLS/CFL/LED	biały mat matte white

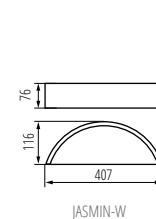

JASMIN-W

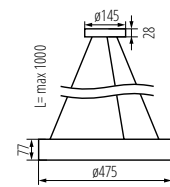

JASMIN 470-H

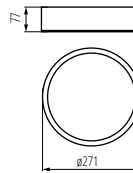

JASMIN 270

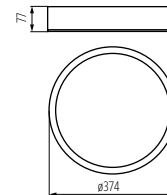

JASMIN 370

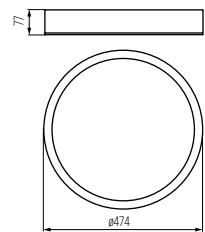

JASMIN 470

[V] 220-240 AC	[Hz] 50/60	[IP] IP 20	[°C] 5+25	[m] 0,5m	[CE]	[EAC]	[K] Kanlux

Kanlux TIVA

PLAFONIERA ► CEILING LIGHT FITTING



TIVA 1130 DDR/ML-SN



TIVA 1030 MDR/ML-SN



TIVA 1030 SDR/ML-DB



TIVA 1130 DDR/ML-OL



TIVA 1030 1/2DR/ML-SN



TIVA 1030 1/2DR/ML-DB



TIVA 1030 1/2DR/ML-OL



Seria plafonier i kinkietów Kanlux TIVA to lampy w których połączono drewno z białym, mlecznym kloszem. Jest to ciekawe wzorniczo zestawienie. Samodzielnie dobierzemy źródło światła o trzonku E27.

Materiał obudowy: drewno

Materiał klosza: szkło

The series of the ceiling light fixtures and wall lamps Kanlux TIVA are lamps which combine wood with a white, milky lampshade. It is an interesting combination in terms of design. You can select the light source with E27 light bulb base on your own.

Enclosure material: Wood

Lampshade material: glass



TIVA 1130 DDR/ML-SN	70710	5905339707109	2 x max 60	E27	GLS/CFL/LED	sosna pine
TIVA 1130 DDR/ML-DB	70711	5905339707116	2 x max 60	E27	GLS/CFL/LED	dąb oak
TIVA 1130 DDR/ML-OL	70717	5905339707178	2 x max 60	E27	GLS/CFL/LED	olcha alder
TIVA 1030 SDR/ML-SN	70720	5905339707208	max 60	E27	GLS/CFL/LED	sosna pine
TIVA 1030 SDR/ML-DB	70721	5905339707215	max 60	E27	GLS/CFL/LED	dąb oak
TIVA 1030 SDR/ML-OL	70727	5905339707277	max 60	E27	GLS/CFL/LED	olcha alder
TIVA 1030 MDR/ML-SN	70730	5905339707307	max 60	E27	GLS/CFL/LED	sosna pine
TIVA 1030 MDR/ML-DB	70731	5905339707314	max 60	E27	GLS/CFL/LED	dąb oak
TIVA 1030 MDR/ML-OL	70737	5905339707376	max 60	E27	GLS/CFL/LED	olcha alder
TIVA 1030 1/2DR/ML-SN	70740	5905339707406	max 60	E27	GLS/CFL/LED	sosna pine
TIVA 1030 1/2DR/ML-DB	70741	5905339707413	max 60	E27	GLS/CFL/LED	dąb oak
TIVA 1030 1/2DR/ML-OL	70747	5905339707475	max 60	E27	GLS/CFL/LED	olcha alder

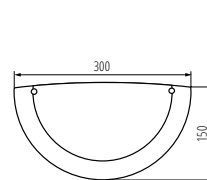

TIVA 1030 1/2DR

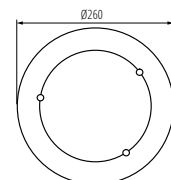

TIVA 1030 MDR

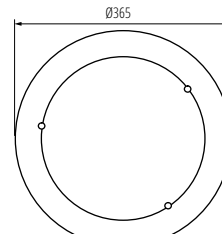

TIVA 1130 DDR

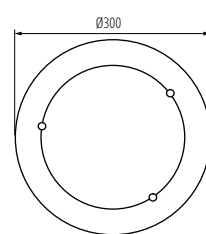

TIVA 1030 SDR

[V] 220-240 AC	[Hz] 50/60	[IP] 20	[°C] 5+25	[m] 0,5m	[A] A A B C D E
[m] 1+2,5	[m] 0,5m	[m] 0,5m	[m] 0,5m	[m] 0,5m	[m] 0,5m



Kanlux ARDEA

PLAFONIERA ► CEILING LIGHT FITTING



ARDEA 1130 DG/ML-SR



Plafon Kanlux ARDEA to oświetlenie uniwersalne. Możemy wykorzystać go do stworzenia kącika wypoczynkowego w salonie lub zamontować go w przedpokoju nad lustrem. Produkt będzie się dobrze prezentował na ścianach i sufitach. Charakteryzuje się uniwersalnym wyglądem – zawdzięcza to prostej stylistyce. Do plafonu Kanlux ARDEA należy dobrać źródło światła z gwintem E27.

powierzchnia klosza równomiernie rozpraszająca światło

Materiał obudowy: stal

Materiał klosza: szkło

Kanlux ARDEA plafon is universal lighting. It can be used to create a relaxation niche in a living room or mounted in a hall above a mirror. The product will look good on walls and ceilings. It is characterized by universal appearance - thanks to simple stylistics. A light source with E27 thread must be added to the Kanlux ARDEA plafon.

the light is diffused uniformly over the diffuser surface

Enclosure material: steel

Lampshade material: glass



ARDEA 1130 DG/ML-SR	70756	5905339707567	2 x max 60	E27	GLS/CFL/LED	chrom chrome
ARDEA 1030 SG/ML-SR	70761	5905339707611	max 60	E27	GLS/CFL/LED	chrom chrome
ARDEA 1130 D/ML-BI	70782	5905339707826	2 x max 60	E27	GLS/CFL/LED	biały white
ARDEA 1030 S/ML-BI	70784	5905339707840	max 60	E27	GLS/CFL/LED	biały white
ARDEA 1030 M/ML-BI	70786	5905339707864	max 60	E27	GLS/CFL/LED	biały white
ARDEA 1030 1/2/ML-BI	70788	5905339707888	max 60	E27	GLS/CFL/LED	biały white

[V] 220-240 AC	[Hz] 50/60	[IP] 20	[°C] 5+25	[m] 0,5m	[E] A A' B C D E

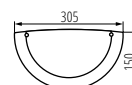

ARDEA 1030 1/2/ML

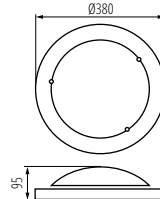

ARDEA 1130 D

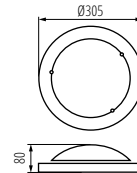

ARDEA 1030 S

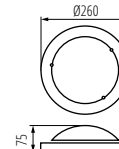

ARDEA 1030 M

Kanlux PLAFMIN

PLAFONIERA ► CEILING LIGHT FITTING



PLAFMIN O



Kanlux PLAFMIN to najbardziej uniwersalna plafoniera w naszej ofercie. Biały kolor, neutralny kształt półkuli, brak jakichkolwiek ozdób i samodzielny wybór źródła światła. Zastosujemy ją w każdym wnętrzu (IP20), szczególnie polecamy ją do hoteli, restauracji i wnętrz domowych w skandynawskim lub minimalistycznym stylu.

Materiał obudowy: tworzywo sztuczne

Materiał klosza: tworzywo sztuczne

Kanlux PLAFMIN is the most universal ceiling light fixture in our offer. White colour, neutral shape of hemisphere, lack of any ornaments and independent selection of light source. It can be used in each interior (IP20), it is particularly recommended to hotels, restaurants and home interiors in the Scandinavian or minimalist style.

Enclosure material: plastic

Lampshade material: plastic



PLAFMIN O	25690	5905339256904	max 40	E27	GLS/CFL/LED	biały white
-----------	--------------	---------------	--------	-----	-------------	---------------

[V] 220-240 AC	[Hz] 50/60	[IP] 20	[°C] 5+25	[m] 0,5m	[E] A A' B C D E

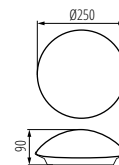

PLAFMIN O

Kanlux VERI LED

PLAFONIERA LED ► CEILING-MOUNTED LED LIGHT FITTING

NEW



VERI LED 36W-NW-O



VERI LED 36W-NW-L



Coraz większą popularnością cieszą się duże plafoniere, stąd pomysł na nietypowe oprawy z efektem 3D - Kanlux VERI. To dekoracyjne oprawy LED o ciekawym wzornictwie. Zastosujemy je z powodzeniem nie tylko w mieszkaniu, ale również w hotelach, restauracjach, a nawet biurach. Wysoki strumień świetlny i unikatowy kształt to niewątpliwe atuty tych opraw.

Materiał obudowy: stal
Materiał klosza: tworzywo sztuczne

Large ceiling light fixtures are increasingly popular, therefore an idea for untypical holders with 3D effect - Kanlux VERI. They are decorative LED holders with interesting design. They can successfully be used in a flat as well as in hotels, restaurants and even in offices. High light stream and unique shape are indisputable assets of these holders.

Enclosure material: steel
Lampshade material: plastic

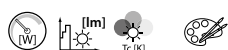

VERI LED 36W-WW-O	29280	5905339292803	36	2340	3000	biały white
VERI LED 36W-WW-L	29281	5905339292810	36	2340	3000	biały white
VERI LED 36W-NW-O	29282	5905339292827	36	2400	4000	biały white
VERI LED 36W-NW-L	29283	5905339292834	36	2400	4000	biały white

[V] 220-240 AC	[Hz] 50/60	[°] 120	[lm] ≥15000	[h] 25000	[lm] ≤6lx Max/dam	Ra ≥80	SMD	⊕	⊕
IP 20	🏠	🌡️ 5+25	🔧	📦	📏 0,75+1,5	📏 0,5m	🚫	CE	ERC

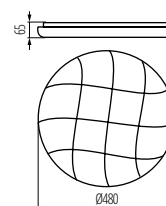

VERI LED 36W-O

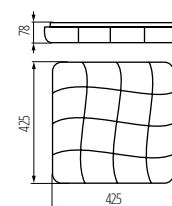

VERI LED 36W-L



MILENO EL-10 B-AG



MILENO EL-10 B-AG	29110	5905339291103	max 35	czarny / złoty black/gold
MILENO EL-10 ASR-AN	29111	5905339291110	max 35	srebrny / miedziany silver / copper
MILENO EL-30 B-AG	29112	5905339291127	3 x max 35	czarny / złoty black/gold
MILENO EL-30 ASR-AN	29113	5905339291134	3 x max 35	srebrny / miedziany silver / copper
MILENO EL-2I B-AG	29114	5905339291141	2 x max 35	czarny / złoty black/gold
MILENO EL-2I ASR-AN	29115	5905339291158	2 x max 35	srebrny / miedziany silver / copper
MILENO EL-3I B-AG	29116	5905339291165	3 x max 35	czarny / złoty black/gold
MILENO EL-3I ASR-AN	29117	5905339291172	3 x max 35	srebrny / miedziany silver / copper
MILENO EL-4I B-AG	29118	5905339291189	4 x max 35	czarny / złoty black/gold
MILENO EL-4I ASR-AN	29119	5905339291196	4 x max 35	srebrny / miedziany silver / copper

[V] 220-240 AC	[Hz] 50/60	PAR16	GU10	IP 20	5+25	300
80	1+2,5	0,5m	CE	ERL	Kanlux	

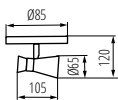

MILENO EL-10

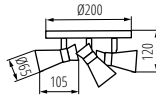

MILENO EL-30

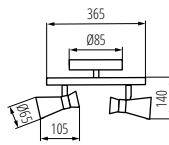

MILENO EL-2I

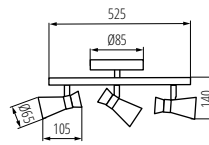

MILENO EL-3I

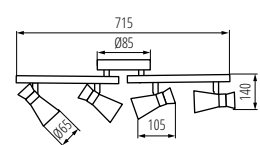

MILENO EL-4I



Kanlux MILENO to odpowiedź na najnowsze trendy. Ciekawe wzornictwo i niebanalny kształt to atuty tej serii. Bardzo duża liczba modeli opraw Kanlux MILENO to dużo większe możliwości aranżacyjne.

Materiał obudowy: stal

Kanlux MILENO follows the latest trends. The advantages of this series are its interesting design and original shape. The very-large number of Kanlux MILENO fixture models means many-more arrangement possibilities.

Enclosure material: steel

Kanlux

MILENO

OPRAWA ŚCIENNO-SUFITOWA ► WALL & CEILING LIGHTING FITTING



MILENO EL-10 ASR-AN



MILENO EL-21 B-AG



MILENO EL-21 ASR-AN



MILENO EL-30 B-AG



MILENO EL-30 ASR-AN



MILENO EL-31 B-AG



MILENO EL-31 ASR-AN



MILENO EL-41 B-AG



MILENO EL-41 ASR-AN



LAURIN

OPRAWA ŚCIENNO-SUFITOWA ► WALL & CEILING LIGHTING FITTING



LAURIN EL-10 B



LAURIN EL-10 W	29120	5905339291202	max 35	biały white
LAURIN EL-10 B	29121	5905339291219	max 35	czarny black
LAURIN EL-21 W	29122	5905339291226	2 x max 35	biały white
LAURIN EL-21 B	29123	5905339291233	2 x max 35	czarny black
LAURIN EL-31 W	29124	5905339291240	3 x max 35	biały white
LAURIN EL-31 B	29125	5905339291257	3 x max 35	czarny black
LAURIN EL-30 W	29126	5905339291264	3 x max 35	biały white
LAURIN EL-30 B	29127	5905339291271	3 x max 35	czarny black
LAURIN EL-40 W	29128	5905339291288	4 x max 35	biały white
LAURIN EL-40 B	29129	5905339291295	4 x max 35	czarny black

[V] 220-240 AC	[Hz] 50/60	PAR16	GU10	IP 20	5+25	310
90	1+2,5	0,5m	CE	ERAC	Kanlux	

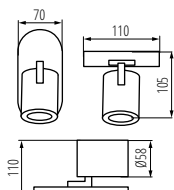

LAURIN EL-10

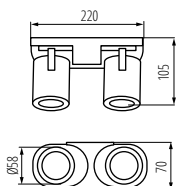

LAURIN EL-21

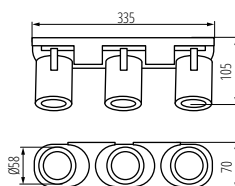

LAURIN EL-31

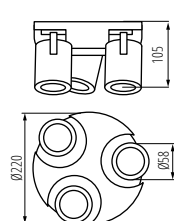

LAURIN EL-30

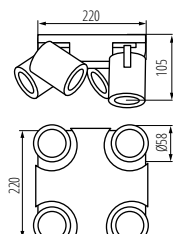

LAURIN EL-40



Spoty Kanlux LARIN to bardzo duży wybór kierunkowych lamp sufitowo-ściennych. Proste i minimalistyczne wzornictwo z powodzeniem możecie zasotsować w wielu pomieszczeniach w domu. Swobodna regulacja kierunku strumienia światła to dodatkowy atut tych opraw.

Materiał obudowy: stop aluminium

Kanlux LARIN spotlights provide a very large selection of directional ceiling and wall lamps. The simple and minimalist design can be successfully used in many rooms in the house. Free adjustment of the luminous flux direction is an additional advantage of these fixtures.

Enclosure material: aluminum alloy

Kanlux

LAURIN

OPRAWA ŚCIENNO-SUFITOWA ► WALL & CEILING LIGHTING FITTING



LAURIN EL-10 W



LAURIN EL-21 W



LAURIN EL-21 B



LAURIN EL-31 W



LAURIN EL-31 B

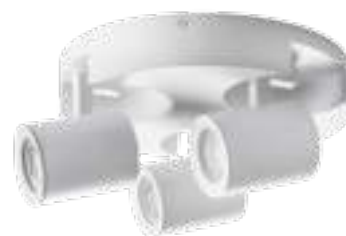

LAURIN EL-30 W



LAURIN EL-30 B



LAURIN EL-40 W



LAURIN EL-40 B

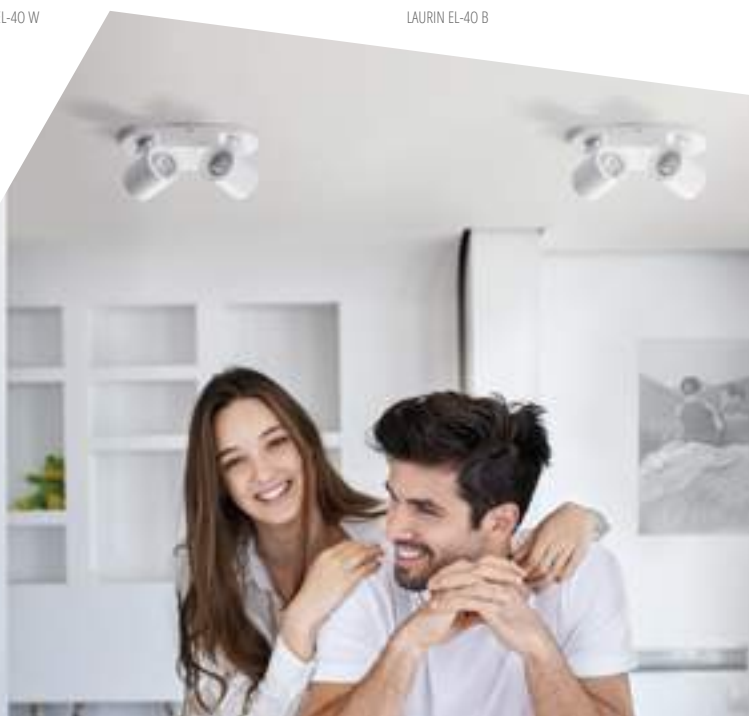

LARITO

OPRAWA ŚCIENNO-SUFITOWA ► WALL & CEILING LIGHTING FITTING



LARITO EL-1L W



Kanlux LARITO to seria opraw punktowych, która cechuje się ponadczasową prostotą. Uniwersalny, klasyczny kształt tych opraw to szerokie możliwości ich zastosowania.

Materiał obudowy: stal

Kanlux LARITO is a series of point fixtures, characterised by timeless simplicity. The universal, classic, shape of these fixtures translates into a wide range of applications.

Enclosure material: steel



LARITO EL-1L-W	28770	5905339287700	max 35	biały white
LARITO EL-1L-B	28771	5905339287717	max 35	czarny black
LARITO EL-2I-W	28772	5905339287724	2 x max 35	biały white
LARITO EL-2I-B	28773	5905339287731	2 x max 35	czarny black
LARITO EL-3I-W	28774	5905339287748	3 x max 35	biały white
LARITO EL-3I-B	28775	5905339287755	3 x max 35	czarny black
LARITO EL-4L-W	28776	5905339287762	4 x max 35	biały white
LARITO EL-4L-B	28777	5905339287779	4 x max 35	czarny black
LARITO EL-4I-W	28778	5905339287786	4 x max 35	biały white
LARITO EL-4I-B	28779	5905339287793	4 x max 35	czarny black

[V] 220-240 AC	[Hz] 50/60	PAR16	GU10	IP 20	80	5+25	330
80	1+2,5	0,5m	CE	ERC	Kanlux A A A B C D E		

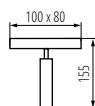

LARITO EL-1L

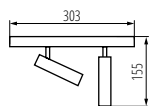

LARITO EL-2I

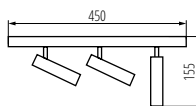

LARITO EL-3I

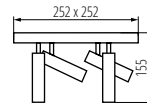

LARITO EL-4L

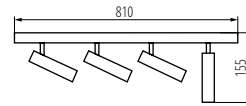

LARITO EL-4I

Kanlux

LARITO

OPRAWA ŚCIENNO-SUFITOWA ► WALL & CEILING LIGHTING FITTING



LARITO EL-1L B



LARITO EL-2I-W



LARITO EL-2I-B



LARITO EL-3I-W



LARITO EL-3I-B



LARITO EL-4I-W



LARITO EL-1L W



LARITO EL-4I-W



LARITO EL-4I-B



Kanlux ENALI

OPRAWA ŚCIENNO-SUFITOWA ► WALL & CEILING LIGHTING FITTING



ENALI EL-10 W



ENALI EL-10 W	28760	5905339287601	max 35	biały white
ENALI EL-10 B	28761	5905339287618	max 35	czarny black
ENALI EL-21 W	28762	5905339287625	2 x max 35	biały white
ENALI EL-21 B	28763	5905339287632	2 x max 35	czarny black
ENALI EL-30 W	28764	5905339287649	3 x max 35	biały white
ENALI EL-30 B	28765	5905339287656	3 x max 35	czarny black
ENALI EL-31 W	28766	5905339287663	3 x max 35	biały white
ENALI EL-31 B	28767	5905339287670	3 x max 35	czarny black
ENALI EL-41 W	28768	5905339287687	4 x max 35	biały white
ENALI EL-41 B	28769	5905339287694	4 x max 35	czarny black

[V] 220-240 AC	[Hz] 50/60	PAR16	GU10	IP 20	5+25	CE	EAC	Kanlux
310	90	1+2,5	1-2,5	0,5m				A A B C D E

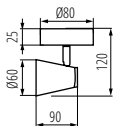

ENALI EL-10

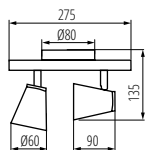

ENALI EL-21

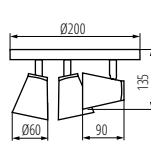

ENALI EL-30

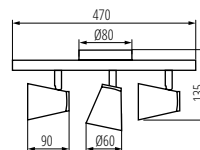

ENALI EL-31

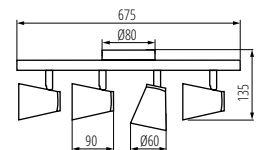

ENALI EL-41



Kanlux ENALI to rodzina opraw punktowych (sufitowo ściennych). Dzięki regulowanym przegubom możemy swobodnie ustawić kąt padania światła. Oprawy idealnie pasują do wnętrz w stylu skandynawskim, ich kształt podkreśli charakter wnętrz retro, a chromowane dodatki dodadzą subtelnego szliflu wnętrzom nowoczesnym.

Materiał obudowy: stal

Materiał klosza: stal

The Kanlux ENALI is a family of point fixtures (ceiling and wall). Thanks to the adjustable joints you can freely set the light-beam angle. The fixtures fit perfectly into Scandinavian style interiors, their shape will emphasise the character of retro interiors, and the chrome accessories will add a subtle touch to modern interiors.

Enclosure material: steel

Lampshade material: steel

Kanlux

ENALI

OPRAWA ŚCIENNO-SUFITOWA ► WALL & CEILING LIGHTING FITTING



ENALI EL-10 B



ENALI EL-21 W



ENALI EL-21 B



ENALI EL-30 W



ENALI EL-30 B



ENALI EL-31 W



ENALI EL-31 B



ENALI EL-41 W



ENALI EL-41 B



Kanlux MOLI

OPRAWA ŚCIENNO-SUFITOWA ► WALL & CEILING LIGHTING FITTING



MOLI EL-10



Kanlux MOLI to rodzina opraw przywodząca na myśl styl retro. Satynowy chrom o opływowych kształtach stanie się ozdobą wnętrz domowych. Oprawy współpracują ze źródłami światła z trzonkiem GU10.

Materiał obudowy: stal

Kanlux MOLI is a family of holders in retro style. The satin chromium in streamlined shapes will become an ornament of home interiors. The holders cooperate with light sources with GU10 light bulb base.

Enclosure material: steel



MOLI EL-21



MOLI EL-30



MOLI EL-41



MOLI EL-10	07085	5905339070852	max 50	chrom mat	chrome matte
MOLI EL-21	07086	5905339070869	2 x max 50	chrom mat	chrome matte
MOLI EL-30	07087	5905339070876	3 x max 50	chrom mat	chrome matte
MOLI EL-41	07088	5905339070883	4 x max 50	chrom mat	chrome matte

[V] 220-240 AC	[Hz] 50/60	PAR16	GU10	IP 20	5+25	CE	ERL
320	90	1+2,5	0,5m				

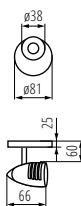

MOLI EL-10

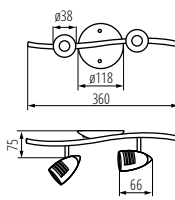

MOLI EL-21

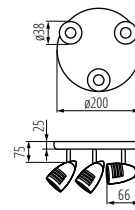

MOLI EL-30

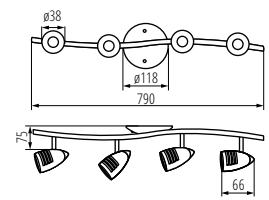

MOLI EL-41

Kanlux SONDA

OPRAWA ŚCIENNO-SUFITOWA ► WALL & CEILING LIGHTING FITTING



SONDA EL-1L



SONDA EL-2J



SONDA EL-3J



SONDA EL-4L



Futurystyczna lampa Kanlux SONDA o nietypowym kształcie jest idealna przede wszystkim do wnętrz urządzonych w nowoczesnym stylu. Wykonana z całości ze stali, stanie się wyrazistą ozdobą każdego pomieszczenia. Reflektor możemy ustawić w dowolnej pozycji kierując światło w pożądaną miejscę.

Materiał obudowy: stal

The Kanlux SONDA futuristic lamp in an untypical shape is mainly ideal for interiors arranged in the modern style. Made of steel in its entirety will become an expressive ornament of each room. The reflector can be positioned freely, directing light into a desirable place.

Enclosure material: steel



SONDA EL-1L	04795	5905339047953	max 50	chrom mat chrome matte
SONDA EL-2J	04796	5905339047960	2 x max 50	chrom mat chrome matte
SONDA EL-3J	04797	5905339047977	3 x max 50	chrom mat chrome matte
SONDA EL-4L	04798	5905339047984	4 x max 50	chrom mat chrome matte

[V]	[Hz]	PAR16	GU10	IP 20	5+25
220-240 AC	50/60				
320	90	1+2,5	0,5m	CE	EAC

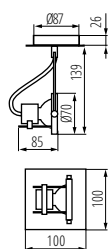

SONDA EL-1L

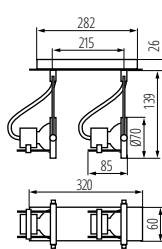

SONDA EL-2J

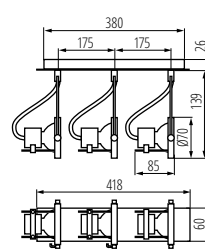

SONDA EL-3J

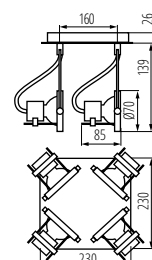

SONDA EL-4L

Kanlux EVELI

OPRAWA ŚCIENNO-SUFITOWA ► WALL & CEILING LIGHTING FITTING

NEW



EVELI EL-10



EVELI EL-21



EVELI EL-30



EVELI EL-41

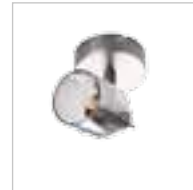

Kanlux EVELI to rodzina opraw, która wyróżnia się bardzo ciekawym wzornictwem. Klosz z dymionego szkła idealnie wpisuje się we wnętrza industrialne, sprawdzi się nie tylko w domu, ale nada również klimatycznego charakteru obiektom HoReCa.

Materiał obudowy: stal
Materiał klosza: szkło

Kanlux EVELI is a family of fixtures which stands out thanks to its very-interesting design. The smoked-glass lampshade fits in with industrial interiors perfectly, and it will prove itself not only at home, but will also provide an appropriate atmosphere in HoReCa interiors.

Enclosure material: steel
Lampshade material: glass



EVELI EL-10	29100	5905339291004	max 35	srebrny silver
EVELI EL-21	29101	5905339291011	2 x max 35	srebrny silver
EVELI EL-30	29102	5905339291028	3 x max 35	srebrny silver
EVELI EL-41	29103	5905339291035	4 x max 35	srebrny silver

[V] 220-240 AC	[Hz] 50/60	G9	G9	IP 20	5+25	CE	ERL	Kanlux
300	90	1+2,5	0,5m					

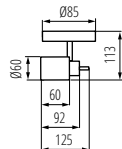

EVELI EL-10

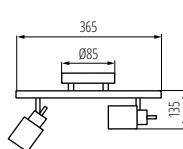

EVELI EL-21

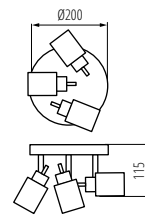

EVELI EL-30

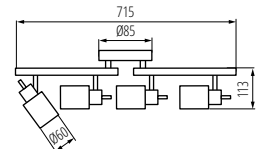

EVELI EL-41



GLASO EL-10



GLASO EL-2I



GLASO EL-3I



GLASO EL-30



GLASO EL-4I



Kanlux GLASO, to rodzina opraw punktowych (sufitowo-ściennych). Dzięki regulacji możemy swobodnie ustawić kąt padania światła. Kształt opraw i ciekawe wzornictwo szklanych kloszy podkreślają charakter wnętrz retro, a chromowane dodatki dodają subtelny szlif nowoczesnym.

Materiał obudowy: stal

Materiał klosza: szkło

Kanlux GLASO is a family of spot beam holders (ceiling and wall). Thanks to adjustment, you can freely set the angle of light. The shape of the holders and interesting design of the glass lampshades emphasize a character of retro interiors and chromium-plated additives will add a subtle cut to modern interiors.

Enclosure material: steel

Lampshade material: glass

GLASO EL-10	19640	5905339196408	max 40	chrom chrome
GLASO EL-2I	19641	5905339196415	2 x max 40	chrom chrome
GLASO EL-3I	19642	5905339196422	3 x max 40	chrom chrome
GLASO EL-4I	19643	5905339196439	4 x max 40	chrom chrome
GLASO EL-30	19644	5905339196446	3 x max 40	chrom chrome

[V]	[Hz]	G9	G9	IP	20	5+25	320
220-240 AC	50/60						
90	1+2,5	0,5m	CE	ERAC	Kanlux		

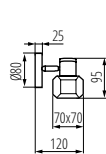

GLASO EL-10

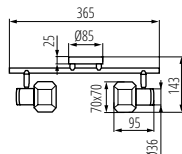

GLASO EL-2I

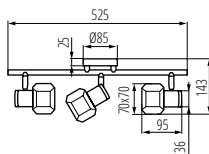

GLASO EL-3I

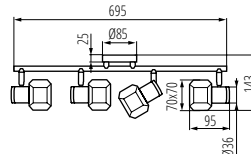

GLASO EL-4I

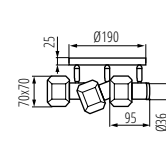

GLASO EL-30



RANVI LED EL-10



Kanlux RANVI to dekoracyjne oprawy domowe ścienna-sufitowe. Posiadają zintegrowane źródła światła LED SMD. Możemy wybrać oprawę posiadającą 1 lub 4 punkty świetlne. Kuliste klosze wykonane ze stali staną się ozdobą każdego pomieszczenia.

Materiał obudowy: stal

Materiał klosza: tworzywo sztuczne

Kanlux RANVI are decorative home wall and ceiling holders. They have integrated LED SMD light sources. You can choose a holder having 1 or 4 light points. The spherical lampshades made of steel will become an ornament of each room.

Enclosure material: steel

Lampshade material: plastic



RANVI LED EL-10



RANVI LED EL-40



RANVI LED EL-10	24430	5905339244307	5	chrom chrome	400	95	2700
RANVI LED EL-40	24433	5905339244338	4 x 5	chrom chrome	4 x 400	95	2700

[V] 220-240 AC	[Hz] 50/60	[h] ≥12000	[h] 17000	[°] ≤60 MacAdam	Ra ≥80	SMD	IP 20
[°C] 5+25	[°] 320	[°] 90	[mm] 1+2,5	[mm] 0,5m	CE	ERAC	Kanlux

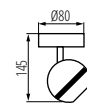

RANVI LED EL-10

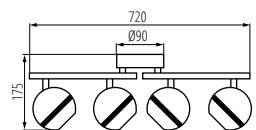

RANVI LED EL-40

Kanlux SILMA

OPRAWA ŚCIENNO-SUFITOWA LED ► WALL/CEILING LED FIXTURE



SILMA LED EL-10



Kanlux SILMA to seria opraw o nietypowym, futurystycznym kształcie. Ciekawy design opraw to przede wszystkim płaskie klosze tych opraw ze zintegrowanymi źródłami światła LED. Możemy wybrać oprawę posiadającą od 1 do 4 punktów świetlnych. Polecamy do nowoczesnych, modernistycznych wnętrz

Materiał obudowy: stal
Materiał klosza: szkło

Kanlux SILMA is a series of holders in an untypical, futuristic shape. Interesting design of the holders means, first of all, flat lampshades of these holders with integrated LED light sources. You can choose a holder having from 1 to 4 light points. They are recommended for modern, modernistic interiors.

Enclosure material: steel
Lampshade material: glass



SILMA LED EL-20

SILMA LED EL-30

SILMA LED EL-40



Model	Code	Part No.	Qty	Color	Material	Beam Angle	Beam Spread	Temp. (K)
SILMA LED EL-10	24440	5905339244406	6	chrom chrome	320	95	3000	
SILMA LED EL-20	24441	5905339244413	2 x 6	chrom chrome	2 x 320	95	3000	
SILMA LED EL-30	24442	5905339244420	3 x 6	chrom chrome	3 x 320	95	3000	
SILMA LED EL-40	24443	5905339244437	4 x 6	chrom chrome	4 x 320	95	3000	

[V]	[Hz]	[lm]	[h]	ellipse	Ra	COB	IP	
220-240 AC	50/60	≥12000	17000	≤ 6x MacAdam	≥80	0,5m	20	
[°C]	[°]	[mm²]	[mm]	[mm]	[mm]	[mm]	[mm]	
5÷25	320	90	1+2,5	0,5m				

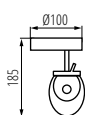

SILMA LED EL-10

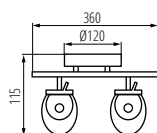

SILMA LED EL-20

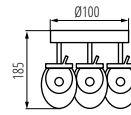

SILMA LED EL-30

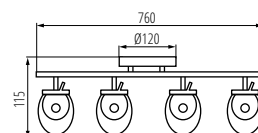

SILMA LED EL-40

Kanlux TUME

OPRAWA ŚCIENNO-SUFITOWA LED ► WALL/CEILING LED FIXTURE



TUME LED EL-10



Kanlux TUME atrakcyjna wizualnie i użytkowo nowoczesna seria opraw ścienna-sufitowych. Oprawy posiadają zintegrowane źródło światła LED COB o ciepłej barwie. Kanlux TUME daje możliwość pełnej regulacji kierunku padania strumienia świetlnego. Nietuzinkowy design sprawia, że oprawa ta świetnie wygląda w nowoczesnych wnętrzach domowych, hotelach i restauracjach.

Materiał obudowy: stal

Kanlux TUME is a visually attractive and attractive in terms of use modern series of wall and ceiling holders. The holders have an integrated LED COB light source with warm colour. Kanlux TUME enables full adjustment of the direction of the light stream. The original design makes this holder look perfect in modern home interiors, hotels and restaurants.

Enclosure material: steel



TUME LED EL-20

TUME LED EL-30



TUME LED EL-40

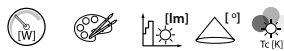

TUME LED EL-10	24450	5905339244505	6	szary grey	500	65	3000
TUME LED EL-20	24451	5905339244512	2 x 6	szary grey	2 x 500	65	3000
TUME LED EL-30	24452	5905339244529	3 x 6	szary grey	3 x 500	65	3000
TUME LED EL-40	24453	5905339244536	4 x 6	szary grey	4 x 500	65	3000

[V] 220-240 AC	[Hz] 50/60	≥ 12000	≤ 60 Maxdram 17000	R_a ≥ 80	COB		IP 20	
	$\leq 5+25$	≤ 320	≤ 90	$\leq 1+2,5$	$\leq 0,5m$		ERAC	

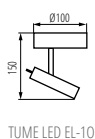

TUME LED EL-10

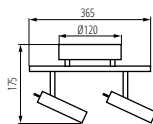

TUME LED EL-20

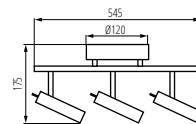

TUME LED EL-30

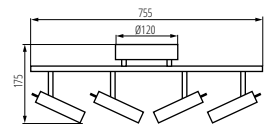

TUME LED EL-40

Kanlux

CHIRO GU10

OPRAWA SUFITOWA PUNKTOWA ▶ CEILING-MOUNTED SPOTLIGHT FITTING

NEW



CHIRO GU10 DTL-B



CHIRO GU10 DTO-W



CHIRO GU10 DTL-W



CHIRO GU10 DTL-B



Kanlux CHIRO GU10, to coś zupełnie nowego w kategorii oświetlenia dekoracyjnego. To oprawa typu SPOT, którą można zamontować w podwieszonym suficie tak jak zwykle oczko. Unikatowy design i montaż tej oprawy to jej największe atuty.

Materiał obudowy: stop aluminium

Kanlux CHIRO GU10, is a completely new category of decorative lighting. It is the SPOT type holder which can be mounted in a suspended ceiling just like an ordinary eye. Unique design and assembly of this holder are its largest assets.

Enclosure material: aluminum alloy



CHIRO GU10 DTO-W	29310	5905339293107	max 35	biały white	w jednej osi in one axis	90
CHIRO GU10 DTO-B	29311	5905339293114	max 35	czarny black	w jednej osi in one axis	90
CHIRO GU10 DTL-W	29312	5905339293121	max 35	biały white	w jednej osi in one axis	90
CHIRO GU10 DTL-B	29313	5905339293138	max 35	czarny black	w jednej osi in one axis	90

[V] 220-240 AC	[Hz] 50/60	PAR16	GU10	IP 20	CE	ERL	Kanlux
5+25	340	Ø70	0,75-1,5	0,5m			

Ø70

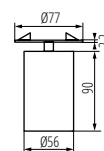

CHIRO GU10 DTO

Ø70

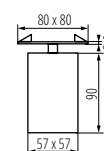

CHIRO GU10 DTL

Kanlux

MINI BORD

PIERŚCIEŃ OPRAWY PUNKTOWEJ ► RING FOR SPOTLIGHT FITTINGS



MINI BORD DLP-50-W



MINI BORD DLP-50-W	28782	5905339287823	max 35	biały white	w jednej osi in one axis	30
MINI BORD DLP-50-B	28783	5905339287830	max 35	czarny black	w jednej osi in one axis	30

[V]							
12 AC; 12 DC; 220-240 AC	MR16/PAR16	Gx5,3/GU10	(mm)	0,5m	CE		
IP 20		5÷25	Ø85				



Mini wersja opraw Kanlux BORD. Doskonała alternatywna dla osób, które chcą stosować oprawy natynkowe na suficie podwieszanym, ponieważ sposób ich montażu jest taki sam jak w przypadku opraw wpuszczanych typu oczko. Dodatkowym atutem jest regulacja kątowa opraw MINI BORD w zakresie 30°.

Materiał obudowy: stop aluminium, stal

The Mini version of the BORD fixtures. A perfect alternative for people who want to use surface-mounted fixtures in a suspended ceiling, because the manner of installation is the same as for recessed-eyelet fixtures. An additional advantage is the angular adjustment of the MINI BORD fixtures within the range of 30°.

Enclosure material: aluminum alloy, steel

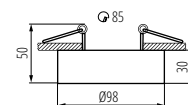

MINI BORD DLP-50

Kanlux

MINI GORD

PIERŚCIEŃ OPRAWY PUNKTOWEJ ► RING FOR SPOTLIGHT FITTINGS



MINI GORD DLP-50-W



MINI GORD DLP-50-W	28780	5905339287809	max 35	biały white	w jednej osi in one axis	30
MINI GORD DLP-50-B	28781	5905339287816	max 35	czarny black	w jednej osi in one axis	30

[V]							
12 AC; 12 DC; 220-240 AC	MR16/PAR16	Gx5,3/GU10	(mm)	0,5m	CE		
IP 20		5÷25	Ø85				



Mini wersja opraw Kanlux GORD. Doskonała alternatywna dla osób, które chcą stosować oprawy natynkowe na suficie podwieszanym, ponieważ sposób ich montażu jest taki sam jak w przypadku opraw wpuszczanych typu oczko. Dodatkowym atutem jest regulacja kątowa opraw MINI GORD w zakresie 30°.

Materiał obudowy: stop aluminium, stal

The Mini version of the GORD fixtures. A perfect alternative for people who want to use surface-mounted fixtures in a suspended ceiling, because the manner of installation is the same as for recessed-eyelet fixtures. An additional advantage is the angular adjustment of the MINI GORD fixtures within the range of 30°.

Enclosure material: aluminum alloy, steel

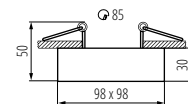

MINI GORD DLP-50

Kanlux GOVIK

PIERŚCIEŃ OPRAWY PUNKTOWEJ ► RING FOR SPOTLIGHT FITTINGS

NEW



GOVIK DSO-W



GOVIK DSO-B



KANLUX GOVIK to nowa oprawa do wbudowania o unikatowej konstrukcji. Zastosowanie matowego, akrylowego klosza rozprasza światło i powoduje, że zainstalowane źródło światła jest niewidoczne. Oprawa wygląda jak miniaturowy zintegrowany natynk.

Materiał obudowy: stop aluminium

KANLUX GOVIK is a new holder for building in with a unique structure. The mat, acrylic lampshade diffuses light and makes the installed light source be invisible. The holder looks like a miniature integrated surface mounted luminaire.

Enclosure material: aluminum alloy



GOVIK DSO-W	29235	5905339292353	max 10	biały white	brak no
GOVIK DSO-B	29236	5905339292360	max 10	czarny black	brak no

 12 AC; 12 DC; 220-240 AC	 MR16/PAR16	 5+25	 GU5.3/GU10	 067	 0,5m		
------------------------------	----------------	----------	----------------	---------	----------	--	--

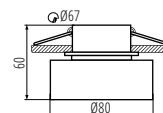

GOVIK DSO

SIMEN DSO

PIERŚCIEŃ OPRAWY PUNKTOWEJ ► RING FOR SPOTLIGHT FITTINGS

NEW



SIMEN DSO SR/B



SIMEN DSO G/W



SIMEN DSO B/G



SIMEN DSO B/W



SIMEN DSO W/B



SIMEN DSO W/G



SIMEN DSO G/B



Kanlux SIMEN DSO to oprawa, która składa się z dwóch części: pierścienia i korpusu. Proponujemy stałe zestawy kolorystyczne, klasyczną czerni i biel lub oprawy zawierające srebrne i złote elementy, które dopasujesz do wnętrza, gdzie staną się one widoczną ozdobą. Możesz również samodzielnie wymieniać elementy z posiadanych zestawów opraw Kanlux SIMEN DSO.

Materiał obudowy: stop aluminium

Kanlux SIMEN DSO is a fixture which consists of two parts - ring, and body. Our range includes permanent colour sets in classic black and white, and fixtures with silver and gold elements, which will fit in with your interior, where they will become a visible decoration. You can also replace individual elements with other Kanlux SIMEN DSO fixture sets you already have.

Enclosure material: aluminum alloy



SIMEN DSO B/G	29137	5905339291370	max 35	czarny / złoty black/gold	brak no
SIMEN DSO B/W	29138	5905339291387	max 35	czarny / biały black/white	brak no
SIMEN DSO W/B	29139	5905339291394	max 35	biały / czarny white / black	brak no
SIMEN DSO W/G	29140	5905339291400	max 35	biały / złoty white / gold	brak no
SIMEN DSO G/B	29141	5905339291417	max 35	złoty / czarny gold / black	brak no
SIMEN DSO G/W	29142	5905339291424	max 35	złoty / biały gold / white	brak no
SIMEN DSO SR/B	29143	5905339291431	max 35	srebrny / czarny silver / black	brak no

VI							
12 AC; 12 DC; 220-240 AC	MR16/PAR16	5+25	Gx5,3/GU10	Ø68	0,5m		
IP 20							

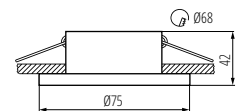

SIMEN DSO

Kanlux

SIMEN DSL

PIERŚCIEŃ OPRAWY PUNKTOWEJ ► RING FOR SPOTLIGHT FITTINGS

NEW



SIMEN DSL SR/B/B



SIMEN DSL W/W/B



SIMEN DSL B/W/B



SIMEN DSL W/W/G



SIMEN DSL B/G/B



SIMEN DSL W/G/W



SIMEN DSL B/B/G

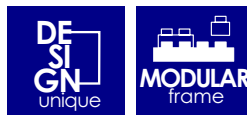

Kanlux SIMEN DSL to oprawa, która składa się z trzech części: pierścienia, korpusu i podstawy. Proponujemy gotowe zestawy kolorystyczne: klasyczną czerń i biel lub oprawy zawierające srebrne i złote elementy, które dopasujesz do wnętrza, gdzie staną się one widoczną ozdobą. Możesz również samodzielnie wymienić elementy z posiadanych zestawów opraw Kanlux SIMEN DSL.

Materiał obudowy: stop aluminium

Kanlux SIMEN DSL is a fixture which consists of three parts - ring, body and base. Our range includes prepared colour sets in classic black and white, or fixtures with silver and gold elements, which will fit in with your interior, where they will become a visible decoration. You can also replace individual elements with other Kanlux SIMEN DSL fixture sets you already have.

Enclosure material: aluminum alloy



SIMEN DSL W/W/B	29130	5905339291301	max 35	biały / biały / czarny white / white / black	brak no
SIMEN DSL B/W/B	29131	5905339291318	max 35	czarny / biały / czarny black / white / black	brak no
SIMEN DSL SR/B/B	29132	5905339291325	max 35	srebrny / czarny / czarny silver / black / black	brak no
SIMEN DSL W/W/G	29133	5905339291332	max 35	biały / biały / złoty white / white / gold	brak no
SIMEN DSL B/G/B	29134	5905339291349	max 35	czarny / złoty / czarny black / gold / black	brak no
SIMEN DSL W/G/W	29135	5905339291356	max 35	biały / złoty / biały white / gold / white	brak no
SIMEN DSL B/B/G	29136	5905339291363	max 35	czarny / czarny / złoty black / black / gold	brak no

12 AC; 12 DC; 220-240 AC	MR16/PAR16	GU5.3/GU10	0,5m	CE	Kanlux
IP 20	5+25	Ø68			

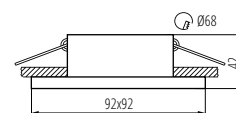

SIMEN DSL

Kanlux LUNIO

PIERŚCIEŃ OPRAWY PUNKTOWEJ ► RING FOR SPOTLIGHT FITTINGS

NEW



LUNIO DTO-W



LUNIO DTO-W | 29230 | 5905339292308 | max 35 | biały | white

[V] 12 AC; 12 DC; 220-240 AC	MR16/PAR16	Gx5,3/GU10	IP 20	5±25	35	350	112	0,5m	CE	Kanlux
---------------------------------	------------	------------	----------	------	----	-----	-----	------	----	--------



Kanlux LUNIO to nowy rodzaj oczka, który charakteryzuje się unikalnym wzorem. Podstawowe ustawienie oczka zapewnia padanie światła pod kątem, 20-35 stopni, możemy jednak obracać podstawę z tubą o kąt 350 stopni. Tuba, w której zamontowane jest źródło, może się opierać o krawędź podstawy lub być cofnięta do wnętrza podstawy.

Materiał obudowy: stop aluminium

Kanlux LUNIO is a new type of eye characterized by unique pattern. The basic setting of the eye ensures that light falls at the angle of 20-35 degrees, however you can turn the base with a tube by the angle of 350 degrees. The tube with the source can be based on the base edge or be moved back into the inside of the base.

Enclosure material: aluminum alloy

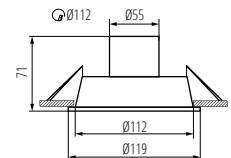

LUNIO DTO

Kanlux IMINES

PIERŚCIEŃ OPRAWY PUNKTOWEJ ► RING FOR SPOTLIGHT FITTINGS

NEW



IMINES DSL-W



IMINES DSL-W | 29030 | 5905339290304 | max 35 | biały mat | matte white | brak | no
IMINES DSO-W | 29031 | 5905339290311 | max 35 | biały mat | matte white | brak | no

[V] 12 AC; 12 DC; 220-240 AC	MR16/PAR16	Gx5,3/GU10	IP 20	5±25	0,5m	CE	Kanlux
---------------------------------	------------	------------	----------	------	------	----	--------



Kanlux IMINES to unikatowa oprawa, która posiada zaskakujący efekt świetlny - po włączeniu światła uzyskujemy dodatkowy, ozdobny pierścień świetlny.

Materiał obudowy: stop aluminium, tworzywo sztuczne

Kanlux IMINES is a unique fixture, which has a surprising light effect - when you turn on the light, you get an additional, decorative light ring.

Enclosure material: aluminum alloy, plastic

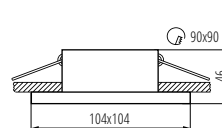

IMINES DSL

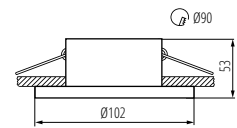

IMINES DSO

BONIS

PIERSIĘĆ OPRAWY PUNKTOWEJ ► RING FOR SPOTLIGHT FITTINGS



BONIS DSO-W



BONIS DSO-C



BONIS DSL-W



BONIS DSL-C



Kanlux BONIS to unikatowy wygląd i jakość wykonania na najwyższym poziomie. Charakteryzują się oryginalnym asymetrycznym kształtem, który dodaje smaku każdemu wnętrzu. W surowych loftach i oszczędnych skandynawskich wnętrzach będzie stanowiła ozdobę, w pomieszczeniach o ekskluzywnym charakterze podkreśli dyskretnie ich klimat.

Materiał obudowy: stop aluminium

The Kanlux BONIS means a unique look and the highest level of workmanship. They are characterised by their original asymmetrical shape, which will be a tasteful addition to any interior. They will serve as decoration in austere lofts and minimalist Scandinavian interiors, and discreetly emphasise the atmosphere of exclusive rooms.

Enclosure material: aluminum alloy



BONIS DSO-W	28700	5905339287007	max 35	biały white	brak no
BONIS DSO-C	28701	5905339287014	max 35	chrom chrome	brak no
BONIS DSL-W	28702	5905339287021	max 35	biały white	brak no
BONIS DSL-C	28703	5905339287038	max 35	chrom chrome	brak no

IV					
12 AC; 12 DC; 220-240 AC	MR16/PAR16	5+25	Ø70	0,5m	CE
IP 20					

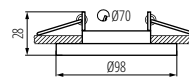

BONIS DSO

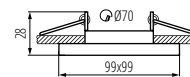

BONIS DSL

ELNIS S

PIERŚCIEŃ OPRAWY PUNKTOWEJ ► RING FOR SPOTLIGHT FITTINGS



ELNIS S W-A



ELNIS S W



ELNIS S A/W



ELNIS S A/C

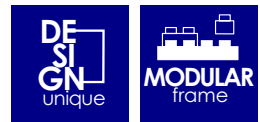

Kanlux Elnis to oprawa, która składa się z dwóch części tworzących całość. To kombinacja dwóch odrębnych elementów: korpusu (zasadniczej części) oraz obudowy (pierścienia dystansowego), tworzących idealnie dopasowaną całość. Wysokość obudowy Elnis S wynosi 10 mm. Kanlux Elnis cechuje nowoczesny wygląd i bardzo wysoka jakość wykonania.

Materiał obudowy: stop aluminium

The Kanlux Elnis is a fixture which consists of two parts forming a whole. It is a combination of two separate elements: the body (the main part) and the casing (the spacer ring), forming a perfectly matched whole. Elnis S is a fixture with a 10-mm-high casing. The Kanlux Elnis is characterised by modern design and very-high quality of workmanship.

Enclosure material: aluminum alloy



ELNIS S W	27800	5905339278005	max 35	biały white	brak no
ELNIS S W/A	27801	5905339278012	max 35	biały / antracyt white/anthracite	brak no
ELNIS S A/W	27802	5905339278029	max 35	antracyt / biały anthracite / white	brak no
ELNIS S A/C	27803	5905339278036	max 35	antracyt / chrom anthracite / chrome	brak no

[VI]						
12 AC; 12 DC; 220-240 AC	MR16/PAR16	Gx5,3/GU10	6x5,3/GU10	Ø70	0,5m	CE
IP 20		5÷25	Ø70	0,5m		

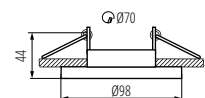

ELNIS S

ELNIS L

PIERŚCIEŃ OPRAWY PUNKTOWEJ ► RING FOR SPOTLIGHT FITTINGS



ELNIS L W/A



ELNIS L W

ELNIS L W/C

ELNIS L A/W

ELNIS L A/C

ELNIS L A

ELNIS L B/G

ELNIS L C/W

ELNIS L C/A

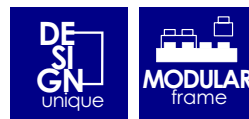

Kanlux Elnis L to oprawa, która składa się z dwóch części tworzących całość. To kombinacja dwóch odrębnych elementów: korpusu (zasadniczej części) oraz obudowy (pierścienia dystansowego), tworzących idealnie dopasowaną całość. Wysokość obudowy Elnis L wynosi 25 mm. Kanlux Elnis L cechuje nowoczesny wygląd i bardzo wysoka

Materiał obudowy: stop aluminium

The Kanlux Elnis L is a fixture which consists of two parts forming a whole. It is a combination of two separate elements: the body (the main part) and the casing (the spacer ring), forming a perfectly matched whole. The Elnis L is a fixture with a 25-mm-high casing. The Kanlux Elnis L is characterised by modern design and very-high quality of workmanship.

Enclosure material: aluminum alloy



ELNIS L W	27804	5905339278043	max 35	biały white	brak no
ELNIS L W/A	27805	5905339278050	max 35	biały / antracyt white/anthracite	brak no
ELNIS L W/C	27806	5905339278067	max 35	biały / chrom white / chrome	brak no
ELNIS L A/W	27807	5905339278074	max 35	antracyt / biały anthracite / white	brak no
ELNIS L A/C	27808	5905339278081	max 35	antracyt / chrom anthracite / chrome	brak no
ELNIS L A	27809	5905339278098	max 35	antracyt anthracite	brak no
ELNIS L B/G	27810	5905339278104	max 35	czarny / złoty black/gold	brak no
ELNIS L C/W	27811	5905339278111	max 35	chrom / biały chrome / white	brak no
ELNIS L C/A	27812	5905339278128	max 35	chrom / antracyt chrome / anthracite	brak no

12 AC; 12 DC; 220-240 AC					
IP 20					
	5+25	Ø70	0,5m		

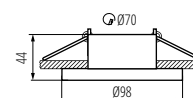

ELNIS L

Kanlux SPAG

PIERŚCIEŃ OPRAWY PUNKTOWEJ ► RING FOR SPOTLIGHT FITTINGS



SPAG C B-G



SPAG L B-G



SPAG S B-G



SPAG D B-G



SPAG L W-G



SPAG S W-G



SPAG C W-G



SPAG D W-G



SPAG L B/G	27320	5905339273208	max 35	czarny / złoty black/gold	brak	no
SPAG L W/G	27321	5905339273215	max 35	biały / złoty white / gold	brak	no
SPAG S B/G	27322	5905339273222	max 35	czarny / złoty black/gold	brak	no
SPAG S W/G	27323	5905339273239	max 35	biały / złoty white / gold	brak	no
SPAG C B/G	27324	5905339273246	max 35	czarny / złoty black/gold	brak	no
SPAG C W/G	27325	5905339273253	max 35	biały / złoty white / gold	brak	no
SPAG D B/G	27326	5905339273260	max 35	czarny / złoty black/gold	brak	no
SPAG D W/G	27327	5905339273277	max 35	biały / złoty white / gold	brak	no

[V] 12 AC; 12 DC; 220-240 AC							
IP 20							

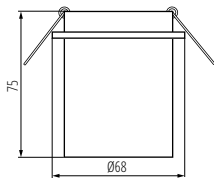

SPAG L

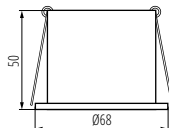

SPAG D

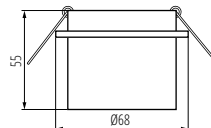

SPAG S

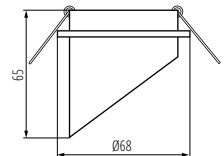

SPAG C



Kanlux SPAG to eleganckie pierścienie ozdobne. Połączenie złota i klasycznej czerni lub bieli dodaje tym oprawom subtelny urok. Dzięki różnym kształtom opraw Kanlux SPAG możemy tworzyć niepowtarzalne i gustowne aranżacje oświetleniowe w naszych salonach, eleganckich restauracjach i apartamentach hotelowych.

Materiał obudowy: stop aluminium

Kanlux SPAG are elegant decorative rings. A combination of gold and classic black or white adds a subtle charm to these holders. Thanks to diverse shapes of the Kanlux SPAG holders, you can create unique and stylish lighting arrangements in your living rooms, elegant restaurants and hotel apartments.

Enclosure material: aluminum alloy

Kanlux

DALLA

OPRAWA SUFITOWA PUNKTOWA ► CEILING-MOUNTED SPOTLIGHT FITTING



DALLA CT-DTL50-B

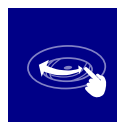

Kanlux DALLA to bardzo starannie wykonana oprawa do montażu wewnątrz. Posiada ruchomy pierścień przez co możemy regulować strumień światła. Jej kształty i uniwersalne kolory pozwalają na osiągnięcie nowoczesnego, dyskretnego efektu elegancji.

Materiał obudowy: stop aluminium

Kanlux DALLA is a very carefully made holder for installation inside. It has a movable ring, thanks to which you can adjust the light stream. Its shapes and universal colours allow achieving a modern, discrete effect of elegance.

Enclosure material: aluminum alloy



DALLA CT-DT050-W	22430	5905339224309	max 50	biały white	w jednej osi in one axis	30
DALLA CT-DTL50-W	22431	5905339224316	max 50	biały white	w jednej osi in one axis	30
DALLA CT-DT050-B	22432	5905339224323	max 50	czarny black	w jednej osi in one axis	30
DALLA CT-DTL50-B	22433	5905339224330	max 50	czarny black	w jednej osi in one axis	30

12 AC; 12 DC	MR-16	Gx5,3	IP 20	
5+25	Ø70	0,12	0,75	0,5m

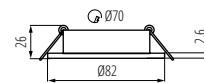

DALLA CT-DT050

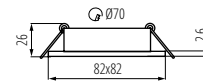

DALLA CT-DTL50

Kanlux

IMOE

PIERŚCIEŃ OPRAWY PUNKTOWEJ ► RING FOR SPOTLIGHT FITTINGS



IMOE DS050



Kanlux IMOE to oprawy charakteryzujące się prostym wzornictwem i bardzo dobrą jakością wykończenia. Wykonane są z masy gipsowej w kolorze białym, jednakże można je pomalować na dowolny kolor czy wzór i perfekcyjnie dopasować do dowolnej aranżacji. Kanlux IMOE stanowią idealną alternatywę dla tradycyjnych „oczek” i znajdują szerokie zastosowanie, szczególnie tam, gdzie wykorzystujemy podwieszane sufity.

Materiał obudowy: odlew gipsowy

Kanlux IMOE are holders characterized by simple design and very good quality of finishing touch. They are made of gypsum mass in white colour, however they can be painted in any colour or pattern and perfectly adapted to any arrangement. Kanlux IMOE are an ideal alternative to traditional "eyes" and can be broadly used especially in places with suspended ceilings.

Enclosure material: plaster cast



IMOE DS050	26070	5905339260703	max 35	biały white	brak no
IMOE DSL50	26071	5905339260710	max 35	biały white	brak no

12 AC; 12 DC; 220-240 AC	MR16/PAR16	Gx5,3/GU10	IP 20	
5+25	Ø70	0,12	0,75	0,5m

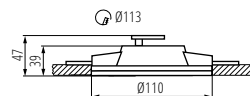

IMOE DS050

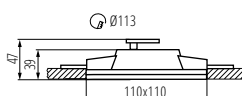

IMOE DSL50

Kanlux SEIDY

OPRAWA SUFITOWA PUNKTOWA ► CEILING-MOUNTED SPOTLIGHT FITTING



SEIDY CT-DT050-AL



Kanlux SEIDY to popularna rodzina opraw, w której możemy wybrać od 1 do 4 punktów świetlnych. Skomponujemy z nich idealne oświetlenie kawiarni, wnętrz hotelowych, ale także zacisza domowego.

Materiał obudowy: stop aluminium

Kanlux SEIDY is a popular family of holders in which you can choose from 1 to 4 light points. You will compose ideal lighting of coffee shops, hotel interiors and privacy interiors of them.

Enclosure material: aluminum alloy



SEIDY CT-DT050-AL	18280	5905339182807	max 50	aluminium szczotkowane	brushed aluminium	w jednej osi	in one axis	30
SEIDY CT-DTL50-AL	18281	5905339182814	max 50	aluminium szczotkowane	brushed aluminium	w jednej osi	in one axis	30
SEIDY CT-DTL250-AL	18282	5905339182821	2 x max 50	aluminium szczotkowane	brushed aluminium	w jednej osi	in one axis	30
SEIDY CT-DTL350-AL	18283	5905339182838	3 x max 50	aluminium szczotkowane	brushed aluminium	w jednej osi	in one axis	30
SEIDY CT-DTL250-B	18284	5905339182845	2 x max 50	czarny anodowany	black anodised	w jednej osi	in one axis	30
SEIDY CT-DTL450-AL	18286	5905339182869	4 x max 50	aluminium szczotkowane	brushed aluminium	w jednej osi	in one axis	30
SEIDY CT-DTL450-B	18287	5905339182876	4 x max 50	czarny anodowany	black anodised	w jednej osi	in one axis	30
SEIDY CT-DT050-B	18288	5905339182883	max 50	czarny anodowany	black anodised	w jednej osi	in one axis	30
SEIDY CT-DTL50-B	18289	5905339182890	max 50	czarny anodowany	black anodised	w jednej osi	in one axis	30
SEIDY CT-DT0350-AL	19452	5905339194527	3 x max 50	aluminium szczotkowane	brushed aluminium	w jednej osi	in one axis	30
SEIDY CT-DT0350-B	19453	5905339194534	3 x max 50	czarny anodowany	black anodised	w jednej osi	in one axis	30
SEIDY CT-DTL50-W/M	19454	5905339194541	max 50	biały mat	matte white	w jednej osi	in one axis	30
SEIDY CT-DTL250-W/M	19455	5905339194558	2 x max 50	biały mat	matte white	w jednej osi	in one axis	30

[VI] 12 AC; 12 DC	MR-16	Gx5,3	IP 20	CE	ERC	Kanlux
5+25	0,12	0,75	0,5m			

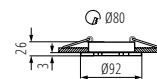

SEIDY CT-DT050

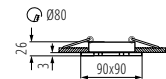

SEIDY CT-DTL50

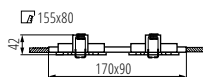

SEIDY CT-DTL250

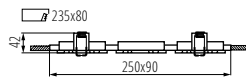

SEIDY CT-DTL350

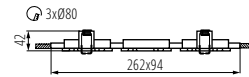

SEIDY CT-DT0350

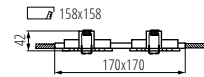

SEIDY CT-DTL450

Kanlux
SEIDY

OPRAWA SUFITOWA PUNKTOWA ▶ CEILING-MOUNTED SPOTLIGHT FITTING



SEIDY CT-DTL50-W/M



SEIDY CT-DTL50-AL



SEIDY CT-DTL50-B



SEIDY CT-DT050-B



SEIDY CT-DTL250-W/M



SEIDY CT-DTL250-AL



SEIDY CT-DTL250-B



SEIDY CT-DT0350-AL



SEIDY CT-DT0350-B



SEIDY CT-DTL350-AL



SEIDY CT-DTL450-AL



SEIDY CT-DTL450-B



MORTA AR-ES

PIERŚCIEŃ OPRAWY PUNKTOWEJ ► RING FOR SPOTLIGHT FITTINGS



MORTA AR/ES O-SR



MORTA AR/ES O-B



MORTA AR/ES L-B



Kanlux MORTA AR/ES jest dostosowany do źródeł AR 111 i ES 111. Dzięki temu możemy uzyskać większy strumień światła niż dotychczas. Kanlux MORTA AR/ES wykonane są z polerowanego szkła o grubości 8mm. Dodatkowym atutem jest regulacja kąta świecenia 20°. Oprawy możemy dopasować do naszej instalacji, sami wybierzemy trzonek i zdecydujemy czy oprawa będzie zastosowana przy 12V czy 230V.

Materiał obudowy: szkło

The Kanlux MORTA AR/ES is adapted to AR 111 and ES 111 sources. This allows you to achieve a luminous flux which is higher than ever before. The Kanlux MORTA AR/ES is in 8mm-thick polished glass. An additional advantage is the adjustment of the direction of illumination by $\pm 20^\circ$. The fixtures can be adjusted to your installation, and you choose the handle yourselves and decide whether the fixture will be used at 12V or 230V.

Enclosure material: glass



MORTA AR/ES O-SR	27960	5905339279606	max 20	srebrny silver	w jednej osi in one axis	20
MORTA AR/ES O-B	27961	5905339279613	max 20	czarny black	w jednej osi in one axis	20
MORTA AR/ES L-B	27963	5905339279637	max 20	czarny black	w jednej osi in one axis	20

[V] 12 AC; 12 DC; 220-240 AC		 AR111 ES111	 GU10/GZ10	 Ø140	 0,5m		
IP 20		 5+25	 Ø140	 0,5m			

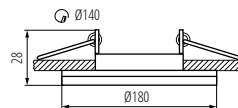

MORTA AS-ES O

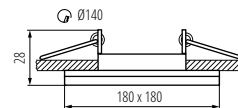

MORTA AR-ES L

Kanlux MORTA

OPRAWA SUFITOWA PUNKTOWA ► CEILING-MOUNTED SPOTLIGHT FITTING



MORTA CT-D5L50-B



MORTA CT-D5L50-B



MORTA CT-D5L50-B



MORTA CT-D5L50-B



MORTA CT-D5L50-B



MORTA CT-D5L50-B



Szeroka gama modeli opraw Kanlux MORTA pozwoli na zrealizowanie bardzo oryginalnych aranżacji w każdym domu. Kanlux MORTA spełnią oczekiwania wszystkich, którzy cenią sobie produkty wysokiej jakości, charakteryzujące się atrakcyjnym i oryginalnym designem.

Materiał obudowy: szkło

A wide range of the Kanlux MORTA holder models will allow making very original arrangements in each house. Kanlux MORTA meet expectations of everyone that highly values products of high quality, characterized by attractive and original design.

Enclosure material: glass



MORTA CT-D5L50-B	18510	5905339185105	max 50	czarny black	brak no
MORTA CT-D5L50-SR	18512	5905339185129	max 50	srebrny silver	brak no
MORTA CT-D5L250-B	19360	5905339193605	2 x max 50	czarny black	brak no
MORTA CT-D5L250-SR	19362	5905339193629	2 x max 50	srebrny silver	brak no
MORTA CT-D5050-B	19440	5905339194404	max 50	czarny black	brak no
MORTA CT-D5050-SR	19442	5905339194428	max 50	srebrny silver	brak no

12 AC; 12 DC	MR-16		Gx5,3			IP 20	
5÷25		0,12	0,75	0,5m			

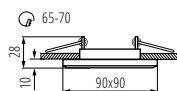

MORTA CT-D5L50

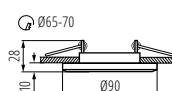

MORTA CT-D5050

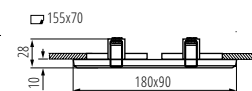

MORTA CT-D5L250

MORTA DT

PIERŚCIEN OPRAWY PUNKTOWEJ ► RING FOR SPOTLIGHT FITTINGS



MORTA CT-DTL50-B



MORTA CT-DT050-SR



MORTA CT-DT050-B



MORTA CT-DTL50-SR

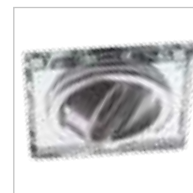

Szeroka gama modeli opraw Kanlux MORTA pozwoli na zrealizowanie bardzo oryginalnych aranżacji w każdym domu. Kanlux MORTA spełnią oczekiwania wszystkich, którzy cenią sobie produkty wysokiej jakości, charakteryzujące się atrakcyjnym i oryginalnym designem.

Materiał obudowy: szkło

A wide range of the Kanlux MORTA holder models will allow making very original arrangements in each house. Kanlux MORTA meet expectations of everyone that highly values products of high quality, characterized by attractive and original design.

Enclosure material: glass



MORTA CT-DT050-SR	26716	5905339267160	max 35	srebrny silver	w jednej osi in one axis	30
MORTA CT-DT050-B	26717	5905339267177	max 35	czarny black	w jednej osi in one axis	30
MORTA CT-DTL50-SR	26718	5905339267184	max 35	srebrny silver	w jednej osi in one axis	30
MORTA CT-DTL50-B	26719	5905339267191	max 35	czarny black	w jednej osi in one axis	30

[V] 12 AC; 12 DC; 220-240 AC						
IP 20						
		5÷25	Ø75-80	0,5m		

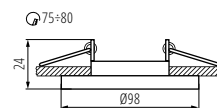

MORTA CT-DT050-SR

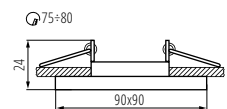

MORTA CT-DTL50

MORTA B

OPRAWA SUFITOWA PUNKTOWA ▶ CEILING-MOUNTED SPOTLIGHT FITTING



MORTA B CT-DSL50-B



MORTA B CT-DSL50-SR



MORTA B CT-DSO50-B



MORTA B CT-DSO50-SR



Szeroka gama modeli opraw Kanlux MORTA pozwoli na zrealizowanie bardzo oryginalnych aranżacji w każdym domu. Kanlux MORTA spełnią oczekiwania wszystkich, którzy cenią sobie produkty wysokiej jakości, charakteryzujące się atrakcyjnym i oryginalnym designem.

Materiał obudowy: szkło

A wide range of the Kanlux MORTA holder models will allow making very original arrangements in each house. Kanlux MORTA meet expectations of everyone that highly values products of high quality, characterized by attractive and original design.

Enclosure material: glass



MORTA B CT-DSL50-B	22110	5905339221100	max 50	czarny black	brak no
MORTA B CT-DSL50-SR	22112	5905339221124	max 50	srebrny silver	brak no
MORTA B CT-DSO50-B	22116	5905339221162	max 50	czarny black	brak no
MORTA B CT-DSO50-SR	22117	5905339221179	max 50	srebrny silver	brak no

[VI] 12 AC; 12 DC	 MR-16	 GX5,3	 III	 IP 20	 House
 5÷25	 Ø65-70	 0,12	 0,75	 0,5m	 CE
					 EAC
					 Kanlux
					 A+ A B C D E

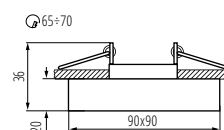

MORTA B CT-DSL50

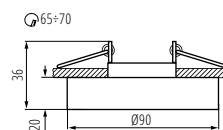

MORTA B CT-DSO50

Kanlux

MORTA OCT

PIERŚCIEŃ OPRAWY PUNKTOWEJ ► RING FOR SPOTLIGHT FITTINGS



Szeroka gama modeli opraw Kanlux MORTA pozwoli na zrealizowanie bardzo oryginalnych aranżacji w każdym domu. Kanlux MORTA spełnią oczekiwania wszystkich, którzy cenią sobie produkty wysokiej jakości, charakteryzujące się atrakcyjnym i oryginalnym designem.

Materiał obudowy: szkło

A wide range of the Kanlux MORTA holder models will allow making very original arrangements in each house. Kanlux MORTA meet expectations of everyone that highly values products of high quality, characterized by attractive and original design.

Enclosure material: glass



MORTA OCT-SR



MORTA OCT-SR	26714	5905339267146	max 35	srebrny silver	brak no
MORTA OCT-B	26715	5905339267153	max 35	czarny black	brak no

[V] 12 AC; 12 DC; 220-240 AC	MR16/PAR16	Gx5,3/GU10	IP 20	5+25	Ø60-65	0,5m	CE	Kanlux
---------------------------------	------------	------------	----------	------	--------	------	----	--------

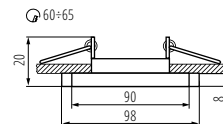

MORTA OCT

Kanlux

APRILA

PIERŚCIEŃ OPRAWY PUNKTOWEJ ► RING FOR SPOTLIGHT FITTINGS



Kanlux APRILA to rodzina białych pierścieni dekoracyjnych wykonanych z aluminium. Kanlux APRILA ma opływowy kształt i możliwość regulacji kąta padania światła w zakresie 20 stopni. W opraw możemy zastosować oprawkę GU10 lub Gx5,3, co pozwoli nam na zastosowanie źródeł światła dopasowanych do przygotowanej instalacji.

Materiał obudowy: stop aluminium

Kanlux APRILA is a family of white decorative rings made of aluminium. Kanlux APRILA has a streamlined shape and can be adjusted in terms of the angle of light within the range of 20 degrees. The JDR or MR-16 frame can be used for the holders, which will allow us to use light sources adapted to a prepared installation.

Enclosure material: aluminum alloy



APRILA DTO-W



APRILA DTO-W	26738	5905339267382	max 35	biały mat matte white	w jednej osi in one axis	20
APRILA DTL-W	26739	5905339267399	max 35	biały mat matte white	w jednej osi in one axis	20

[V] 12 AC; 12 DC; 220-240 AC	MR16/PAR16	Gx5,3/GU10	IP 20	5+25	Ø90	0,5m	CE	Kanlux
---------------------------------	------------	------------	----------	------	-----	------	----	--------

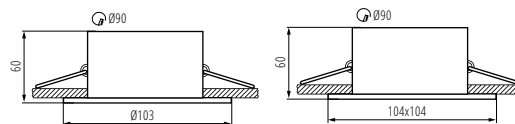

APRILA DTO

APRILA DTL

Kanlux SOREN

OPRAWA SUFITOWA PUNKTOWA ▶ CEILING-MOUNTED SPOTLIGHT FITTING



SOREN O-SR WW



SOREN O-SR WW



SOREN O-BL



SOREN O-GN



SOREN O-SR CW



SOREN L-SR WW



SOREN L-BL



SOREN L-GN



SOREN L-SR CW



Kanlux SOREN to szklane oprawy, których dodatkowym atutem jest kolorowy, dekoracyjny pasek LED rozświetlający szklaną podstawę oprawy.

Materiał obudowy: szkło

Kanlux SOREN are glass holders whose additional asset is the colourful, decorative LED strip lighting up the glass base of the holder.

Enclosure material: glass



SOREN O-SR WW	24410	5905339244109	max 20	srebrny silver	ciepłobiała warm white	brak no
SOREN O-BL	24411	5905339244116	max 20	srebrny silver	niebieska blue	brak no
SOREN O-GN	24412	5905339244123	max 20	srebrny silver	zielona green	brak no
SOREN L-SR WW	24413	5905339244130	max 20	srebrny silver	ciepłobiała warm white	brak no
SOREN L-BL	24414	5905339244147	max 20	srebrny silver	niebieska blue	brak no
SOREN L-GN	24415	5905339244154	max 20	srebrny silver	zielona green	brak no
SOREN O-SR CW	24416	5905339244161	max 20	srebrny silver	chłodnobiała cold white	brak no
SOREN L-SR CW	24417	5905339244178	max 20	srebrny silver	chłodnobiała cold white	brak no

[VI] 220-240 AC	[Hz] 50/60	PAR16	GU10	IP 20
5+25	0,5m	SMD	CE	EAC

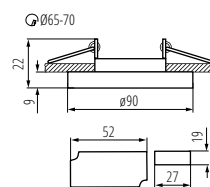

SOREN O

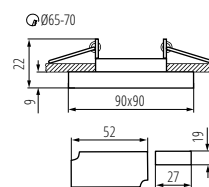

SOREN L

Kanlux IVRI

PIERŚCIEŃ OPRAWY PUNKTOWEJ ► RING FOR SPOTLIGHT FITTINGS

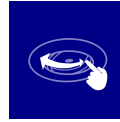

Kanlux IVRI to rodzina pierścieni dekoracyjnych wykonanych z aluminium. Kanlux IVRI jest wyrazisty w swoim kształcie, a regulacja kierunku świecenia źródła światła wynosi 30 stopni.

Materiał obudowy: stop aluminium

Kanlux IVRI is a family of decorative rings made of aluminium. Kanlux IVRI is expressive in its shape and adjustment of the direction of light - light source comes to 30 degrees.

Enclosure material: aluminum alloy



IVRI DTO-W



IVRI DTO-W | 26736 | 5905339267368 max 35 biały | white w jednej osi | in one axis 30

[V] 12 AC; 12 DC; 220-240 AC	MR16/PAR16	Gx5.3/GU10	IP 20
5+25	0,5m	CE	Kanlux A A A B C D E

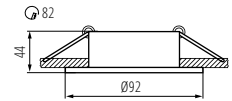

IVRI DTO

Kanlux CEMIN

PIERŚCIEŃ OPRAWY PUNKTOWEJ ► RING FOR SPOTLIGHT FITTINGS

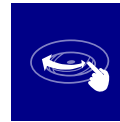

Kanlux CEMIN to oprawa wykonana z masy betonopodobnej z możliwością regulacji kierunku świecenia. Surowe, naturalne oprawy mają charakter industrialny i doskonale sprawdzą się w aranżacji wnętrz w stylu industrialnym oraz loftowym.

Materiał obudowy: beton

Kanlux CEMIN is a holder made of mass similar to concrete with a possibility of adjusting the direction of light. Raw, natural holders have industrial character and are perfect in arrangement of interiors in the industrial and loft-like style.

Enclosure material: concrete



CEMIN DTL-GR



CEMIN DTL-GR | 27230 | 5905339272300 max 35 szary | grey w jednej osi | in one axis 30

[V] 12 AC; 12 DC; 220-240 AC	MR16/PAR16	Gx5.3/GU10	IP 20
5+25	30	Ø70	0,5m

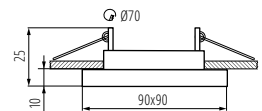

CEMIN DTL

Kanlux ARET

PIERŚCIEŃ OPRAWY PUNKTOWEJ ► RING FOR SPOTLIGHT FITTINGS



ARET 1xMR16-W



ARET 1xMR16-GR



ARET 2xMR16-W



ARET 2xMR16-GR



ARET 2xMR16-C/M



Rodzina opraw Kanlux ARET to pierścienie ozdobne wykonane ze stopu aluminium oraz blachy stalowej. Oczka te są bez oprawki – sami decydujemy czy dodamy do niego oprawkę GZ10 czy GX5.3. Pozwala nam to dopasować źródła światła do instalacji, którą mamy w danym pomieszczeniu. Kanlux ARET sprawdzą się jako oświetlenie pomocnicze, zarówno w domach, barach jak i w restauracjach, wszędzie tam gdzie chcemy zaakcentować ciekawą aranżację pomieszczenia lub wyeksponować jego fragment.

Materiał obudowy: stop aluminium

A family of the Kanlux ARET holders are decorative rings made of aluminium alloy and steel metal sheet. These eyes are without a frame - you decide on your own whether to add the GZ10 or GX5.3 frame to it. It allows adapting the light source to an installation available in a given room. Kanlux ARET works well as additional lighting both at homes, in bars and in restaurants, in places where you want to emphasize an interesting arrangement of a room or to display its fragment.

Enclosure material: aluminum alloy



ARET 1xMR16-W	26720	5905339267207	max 35	biały white	w jednej osi in one axis	20
ARET 1xMR16-GR	26721	5905339267214	max 35	szary grey	w jednej osi in one axis	20
ARET 2xMR16-W	26723	5905339267238	2 x max 35	biały white	w jednej osi in one axis	20
ARET 2xMR16-GR	26724	5905339267245	2 x max 35	szary grey	w jednej osi in one axis	20
ARET 2xMR16-C/M	26725	5905339267252	2 x max 35	chrom mat chrome matte	w jednej osi in one axis	20

IWI					
12 AC; 12 DC; 220-240 AC	MR16/PAR16		Gx5.3/GU10		
IP 20					
		5+25	0,5m		

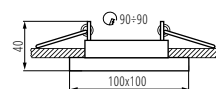

ARET 1xMR16

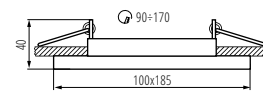

ARET 2xMR16

Kanlux MERIL

OPRAWA SUFITOWA PUNKTOWA ► CEILING-MOUNTED SPOTLIGHT FITTING



MERIL DLP-50-W



MERIL DLP-50-W	26480	5905339264800	max 35	biały white	w dwóch osiach in two axes	30/30
MERIL DLP-250-W	26481	5905339264817	2 x max 35	biały white	w dwóch osiach in two axes	30/30

220-240 AC	PAR16	GU10	5+25	1+2,5	0,5m		IP 20	
------------	-------	------	------	-------	------	--	-------	--



Kanlux MERIL to oprawy typu downlight z wymiennym źródłem światła. Oprawy dostępne są w wersji jedno i dwupunktowej, a ich istotną cechą jest możliwość swobodnej regulacji kątownej.

Materiał obudowy: stal

Kanlux MERIL are holders of downlight type with a replaceable source of light. The holders are available in one-spot beam and two-spot beam version and their significant feature is a possibility of free adjustment of the angle.

Enclosure material: steel

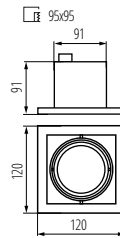

MERIL DLP-50

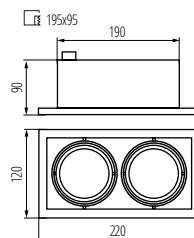

MERIL DLP-250

Kanlux ALREN R

PIERŚCIEŃ OPRAWY PUNKTOWEJ ► RING FOR SPOTLIGHT FITTINGS



ALREN R DTL-W



ALREN R DTL-B	26757	5905339267573	max 35	czarny black	w dwóch osiach in two axes	60/60
ALREN R DTL-W	26758	5905339267580	max 35	biały white	w dwóch osiach in two axes	60/60

12 AC; 12 DC; 220-240 AC	MR16/PAR16	Gx5,3/GU10	5+25	60	80x80		IP 20	
--------------------------	------------	------------	------	----	-------	--	-------	--



Model pierścieni dekoracyjnych Kanlux ALREN R to ciekawy, niespotykany na rynku kształt opraw - oczka z zaokrąglonymi narożnikami. Możliwość regulacji o 60 stopni w dwóch płaszczyznach to ich niewątpliwa zaleta. Kanlux ALREN R oferowane są bez oprawki.

Materiał obudowy: stop aluminium

Kanlux ALREN R decorative rings have an interesting shape of fixtures never before seen on the market - eyelets with rounded corners. The possibility of 60-degree adjustment in two planes is an unquestionable advantage. The Kanlux ALREN R is supplied without a socket.

Enclosure material: aluminum alloy

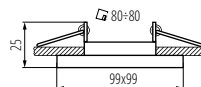

ALREN R DTL

ALREN

PIERŚCIEŃ OPRAWY PUNKTOWEJ ► RING FOR SPOTLIGHT FITTINGS



ARLEN DTL-W



ARLEN DTL-B



ARLEN DTL-C



ARLEN DTL-C/M



Pierścienie dekoracyjne Kanlux ALREN oferowane są bez oprawki – sami decydujemy czy dodamy do niego oprawkę GX10 czy GX5.3. Oprawy do wbudowania w sufit świetnie sprawdzają się jako oświetlenie pomocnicze w domach, barach, restauracjach, wszędzie tam gdzie chcemy zaakcentować aranżację pomieszczenia lub wyeksponować jego fragment.

Materiał obudowy: stop aluminium

The Kanlux ALREN decorative rings are offered without a frame - you decide on your own whether to add the GX10 or GX5.3 frame to it. The holders for building in a ceiling work well as additional lighting at homes, in bars and in restaurants, in places where you want to emphasize an arrangement of a room or to display its fragment.

Enclosure material: aluminum alloy



ALREN DTL-W	26753	5905339267535	max 35	biały mat matte white	w jednej osi in one axis	15
ALREN DTL-B	26754	5905339267542	max 35	czarny mat black matt	w jednej osi in one axis	15
ALREN DTL-C	26755	5905339267559	max 35	chrom chrome	w jednej osi in one axis	15
ALREN DTL-C/M	26756	5905339267566	max 35	chrom mat chrome matte	w jednej osi in one axis	15

[VI]					
12 AC; 12 DC; 220-240 AC	MR16/PAR16	5+25	Gx5.3/GX10	83x83 (mm)	0,5m
IP 20					

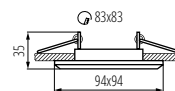

ARLEN DTL

Kanlux COLIE

PIERŚCIEŃ OPRAWY PUNKTOWEJ ► RING FOR SPOTLIGHT FITTINGS



COLIE DTO-G



COLIE DTO-W



COLIE DTO-AL



COLIE DTO-B



COLIE DTO-GR



Ozdobne pierścienie Kanlux COLIE pozwolą na zrealizowanie bardzo oryginalnych aranżacji w każdym domu. Charakteryzują się eleganckim i oryginalnym wzornictwem, zapewniając przy tym dyskretny rozsył światła. Seria COLIE przeznaczona jest do wbudowania w sufit. Znakomicie sprawdzają się jako oświetlenie pomocnicze, zarówno w domach, w barach jak i restauracjach, wszędzie tam gdzie chcemy zaakcentować ciekawą aranżację pomieszczenia.

Materiał obudowy: stop aluminium

The Kanlux COLIE decorative rings will allow making very original arrangements in each house. They are characterized by elegant and original design ensuring, at the same time, discrete distribution of light. The COLIE series is intended for building in a ceiling. They work well as additional lighting both at homes, in bars and in restaurants, in places where you want to emphasize an interesting arrangement of a room.

Enclosure material: aluminum alloy



Model	Code	Part No.	Height	Finish	Beam Angle	Height
COLIE DTO-W	26740	5905339267405	max 35	biały mat matte white	w jednej osi in one axis	15
COLIE DTO-G	26741	5905339267412	max 35	złoty anodowany gold anodised	w jednej osi in one axis	15
COLIE DTO-AL	26742	5905339267429	max 35	aluminium	w jednej osi in one axis	15
COLIE DTO-B	26743	5905339267436	max 35	czarny mat black matt	w jednej osi in one axis	15
COLIE DTO-GR	26744	5905339267443	max 35	szary grey	w jednej osi in one axis	15

12 AC; 12 DC; 220-240 AC	MR16/PAR16	6x5,3/GU10	0,5m	CE
IP 20	5÷25	Ø75	0,5m	Kanlux

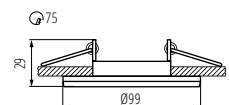

COLIE DTO

Kanlux NESTA

PIERŚCIEŃ OPRAWY PUNKTOWEJ ► RING FOR SPOTLIGHT FITTINGS



NESTA DSL-W



NESTA DTL-B



NESTA DTL-C



NESTA DTL-C/M



NESTA DSL-B



NESTA DSL-C



NESTA DSL-C/M



NESTA DSL-W

Oczka Kanlux NESTA dostępne są w wersji z ruchomym pierścieniem, pozwalającym na ukierunkowanie światła w daną stronę oraz z pierścieniem nieruchomym. Oprawy przeznaczone do wbudowania w sufit świetlnie sprawdzają się jako oświetlenie pomocnicze, zarówno w domach, kawiarniach, restauracjach - wszędzie tam gdzie chcemy zaakcentować ciekawą aranżację pomieszczenia. Zestawiane w grupę oprawy te mogą również z powodzeniem pełnić funkcję oświetlenia głównego.

Materiał obudowy: stop aluminium

The Kanlux NESTA eyes are available in a version with a movable ring, allowing to direct light into a given side and with an immovable ring. The holders intended for building in a ceiling work well as additional lighting both at homes, in coffee shops and in restaurants, in places where you want to emphasize an interesting arrangement of a room. These holders combined in a group can also successfully perform the function of main light.

Enclosure material: aluminum alloy



NESTA DSL-W	26745	5905339267450	max 35	biały mat matte white	brak no
NESTA DSL-B	26746	5905339267467	max 35	czarny mat black matt	brak no
NESTA DSL-C	26747	5905339267474	max 35	chrom chrome	brak no
NESTA DSL-C/M	26748	5905339267481	max 35	chrom mat chrome matte	brak no
NESTA DTL-W	26749	5905339267498	max 35	biały mat matte white	w jednej osi in one axis 30
NESTA DTL-B	26750	5905339267504	max 35	czarny mat black matt	w jednej osi in one axis 30
NESTA DTL-C	26751	5905339267511	max 35	chrom chrome	w jednej osi in one axis 30
NESTA DTL-C/M	26752	5905339267528	max 35	chrom mat chrome matte	w jednej osi in one axis 30

12 AC; 12 DC; 220-240 AC	MR16/PAR16		Gx5,3/GU10	
IP 20			0,5m	

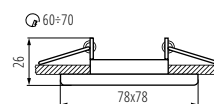

NESTA DSL

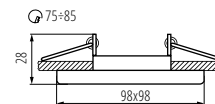

NESTA DTL

Kanlux EVIT

OPRAWA SUFITOWA PUNKTOWA ► CEILING-MOUNTED SPOTLIGHT FITTING



EVIT CT-DT050-AL



EVIT CT-DTL50-AL	18560	5905339185600	max 50	aluminium	w jednej osi in one axis	30
EVIT CT-DT050-AL	18561	5905339185617	max 50	aluminium	w jednej osi in one axis	30

[VI] 12 AC; 12 DC	MR-16	Gx5,3	III	IP 20	5+25	Ø70-75	0,12	0,75	0,5m	CE	ERAC	Kanlux
5+25	Ø70-75	0,12	0,75	0,5m	CE	ERAC	A A B C D E					

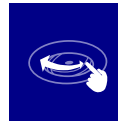

Kanlux EVIT to oprawa punktowa wykonana z aluminium. Posiada możliwość regulacji kierunku padania światła. Kanlux EVIT jest klasycznym oczkiem bez ozdóbek.

Materiał obudowy: stop aluminium

Kanlux EVIT is a spot-beam holder made of aluminium. It has a possibility of adjusting the direction of light. Kanlux EVIT is a classic eye without ornaments.

Enclosure material: aluminum alloy

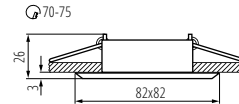

EVIT CT-DTL50

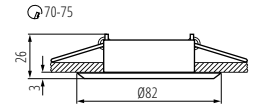

EVIT CT-DT050

Kanlux GWEN

OPRAWA SUFITOWA PUNKTOWA ► CEILING-MOUNTED SPOTLIGHT FITTING



GWEN CT-DT050-B



GWEN CT-DTL50-B	18530	5905339185303	max 50	czarny anodowany black anodised	w jednej osi in one axis	30
GWEN CT-DT050-B	18531	5905339185310	max 50	czarny anodowany black anodised	w jednej osi in one axis	30

[VI] 12 AC; 12 DC	MR-16	Gx5,3	III	IP 20	5+25	Ø70-75	0,12	0,75	0,5m	CE	ERAC	Kanlux
5+25	Ø70-75	0,12	0,75	0,5m	CE	ERAC	A A B C D E					

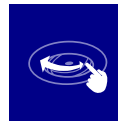

Kanlux GWEN to oczko, które idealnie pasuje do wnętrza eleganckich, stonowanych. Szczotkowane aluminium w czarnym kolorze doda szyku oświetlanemu wnętrzu.

Materiał obudowy: stop aluminium

Kanlux GWEN is an eye which perfectly fits into elegant, discreet interiors. Brushed aluminium in black colour will add stylishness to lighted interior.

Enclosure material: aluminum alloy

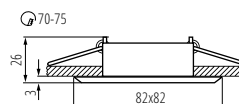

GWEN CT-DTL50

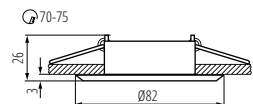

GWEN CT-DT050

Kanlux VIDI

OPRAWA SUFITOWA PUNKTOWA ► CEILING-MOUNTED SPOTLIGHT FITTING



VIDI CTC-5514-AN



VIDI CTC-5515-W



VIDI CTC-5515-C



VIDI CTC-5515-C/M



VIDI CTC-5515-PN



VIDI CTC-5515-B



VIDI CTC-5514-W



VIDI CTC-5514-C



VIDI CTC-5514-C/M



VIDI CTC-5514-MPC



VIDI CTC-5514-B

Kanlux VIDI to rodzina prostych w swojej formie, różnorodnych opraw punktowych. Możemy komponować z nich różnorodne zestawy oświetleniowe wybierając wśród wielu kolorów tych aluminiowych opraw.

Materiał obudowy: stop aluminium

Kanlux VIDI is a family of simple in their form, diverse spot-beam holders. You can compose diverse lighting sets of them, choosing from among many colours of these aluminium holders.

Enclosure material: aluminum alloy



VIDI CTC-5515-W	02780	5905339027801	max 50	biały white	w jednej osi in one axis	15
VIDI CTC-5515-C	02781	5905339027818	max 50	chrom chrome	w jednej osi in one axis	15
VIDI CTC-5515-C/M	02783	5905339027832	max 50	chrom mat chrome matte	w jednej osi in one axis	15
VIDI CTC-5515-AN	02785	5905339027856	max 50	miedź matowa matte copper	w jednej osi in one axis	15
VIDI CTC-5515-PN	02787	5905339027870	max 50	nikiel satynowy nickel satin	w jednej osi in one axis	15
VIDI CTC-5514-W	02790	5905339027900	max 50	biały white	brak no	
VIDI CTC-5514-C	02791	5905339027917	max 50	chrom chrome	brak no	
VIDI CTC-5514-C/M	02793	5905339027931	max 50	chrom mat chrome matte	brak no	
VIDI CTC-5514-AN	02795	5905339027955	max 50	miedź matowa matte copper	brak no	
VIDI CTC-5514-MPC	02812	5905339028129	max 50	chrom satynowy chrome Satin	brak no	
VIDI CTC-5514-B	25995	5905339025995	max 50	czarny mat black matt	brak no	
VIDI CTC-5515-B	25996	5905339025996	max 50	czarny mat black matt	w jednej osi in one axis	15

IV	MR-16	Gx5,3	IP 20	CE	ERL	Kanlux
12 AC; 12 DC						
5÷25	0,12	0,75	0,5m			

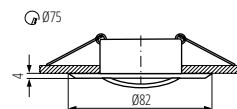

VIDI CTC-5515

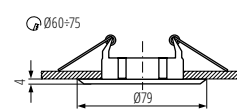

VIDI CTC-5514



NAVI CTX-DT10-W



NAVI CTX-DT10-C



NAVI CTX-DT10-C/M



NAVI CTX-DT10-AB



NAVI CTX-DT10-B



NAVI CTX-DS10-AB



NAVI CTX-DS10-C



NAVI CTX-DS10-SN



NAVI CTX-DS10-B

Kanlux NAVI to rodzina prostych w swojej formie, różnorodnych opraw punktowych o bardzo szerokich możliwościach zastosowania.

Materiał obudowy: stop aluminium

Kanlux NAVI is a family of simple in their form, diverse spot-beam holders with very broad possibilities of use.

Enclosure material: aluminum alloy



NAVI CTX-DT10-W	02550	5905339025500	max 50	biały white	w jednej osi in one axis	15
NAVI CTX-DT10-C	02551	5905339025517	max 50	chrom chrome	w jednej osi in one axis	15
NAVI CTX-DT10-C/M	02553	5905339025531	max 50	chrom mat chrome matte	w jednej osi in one axis	15
NAVI CTX-DT10-AB	02554	5905339025548	max 50	mosiądz matowy matt brass	w jednej osi in one axis	15
NAVI CTX-DS10-AB	04693	5905339046932	max 50	mosiądz matowy matt brass	brak no	
NAVI CTX-DS10-C	04694	5905339046949	max 50	chrom chrome	brak no	
NAVI CTX-DS10-SN	04695	5905339046956	max 50	nikiel mat nickel matte	brak no	
NAVI CTX-DS10-B	25990	5905339259905	max 50	czarny mat black matt	brak no	
NAVI CTX-DT10-B	25991	5905339259912	max 50	czarny mat black matt	w jednej osi in one axis	15

12 AC; 12 DC	MR-16	Gx5,3	IP 20	
5+25	0,12	0,75	0,5m	CE

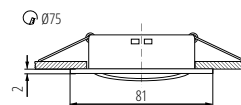

NAVI CTX-DT10

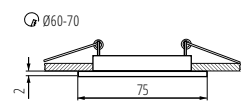

NAVI CTX-DS10

Kanlux LUTO

OPRAWA SUFITOWA PUNKTOWA ▶ CEILING-MOUNTED SPOTLIGHT FITTING



LUTO CTX-DS02B-C



LUTO CTX-DS02B-W



LUTO CTX-DS02B-AB



LUTO CTX-DT02B-W



LUTO CTX-DT02B-C



LUTO CTX-DT02B-C/M



LUTO CTX-DT02B-AB

Kanlux LUTO to linia klasycznych oczek w stonowanych kolorach. Biały, patynowany mosiądz czy matowy chrom dyskretnie dodadzą uroku nie tylko przestrzeni domowej, ale również hotelom i kawiarniom.

Materiał obudowy: stop aluminium

Kanlux LUTO is a line of classic eyes in discreet colours. The white, patina brass or matt chromium will discretely add charm to a home space as well as to hotels and coffee shops.

Enclosure material: aluminum alloy



LUTO CTX-DS02B-W	02580	5905339025807	max 50	biały white	brak no
LUTO CTX-DS02B-C	02581	5905339025814	max 50	biały white	brak no
LUTO CTX-DS02B-C/M	02583	5905339025838	max 50	chrom mat chrome matte	brak no
LUTO CTX-DS02B-AB	02584	5905339025845	max 50	mosiądz matowy matt brass	brak no
LUTO CTX-DT02B-W	02590	5905339025906	max 50	biały white	w jednej osi in one axis 15
LUTO CTX-DT02B-C	02591	5905339025913	max 50	chrom chrome	w jednej osi in one axis 15
LUTO CTX-DT02B-C/M	02593	5905339025937	max 50	chrom mat chrome matte	w jednej osi in one axis 15
LUTO CTX-DT02B-AB	02594	5905339025944	max 50	mosiądz matowy matt brass	w jednej osi in one axis 15

[V] 12 AC; 12 DC	MR-16	Gx5,3	IP 20	20
----------------------------	--------------	--------------	--------------	-----------

5÷25	0,12	0,75	0,5m	CE	ERL	Kanlux
-------------	-------------	-------------	-------------	-----------	------------	---------------

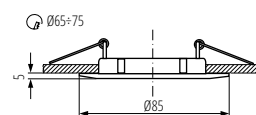

LUTO CTX-DS02B

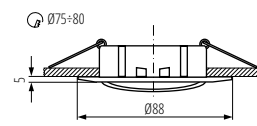

LUTO CTX-DT02B

Kanlux RADAN

OPRAWA SUFITOWA PUNKTOWA ► CEILING-MOUNTED SPOTLIGHT FITTING



RADAN CT-DT050

Kanlux RADAN to proste oczka, które rozjaśnią każde pomieszczenie. Sami wybierzemy źródło światła jak i wersję oprawy - z regulacją lub nieruchomą.

Materiał obudowy: stop aluminium

Kanlux RADAN are simple eyes which will light up each room. You can choose a source of light and a version of the holder on your own - with adjustment or immovable.

Enclosure material: aluminum alloy



RADAN CT-DT050



RADAN CT-DTL50



RADAN CT-DS050



RADAN CT-DT050	07360	5905339073600	max 50	aluminium	w jednej osi in one axis	30
RADAN CT-DTL50	07361	5905339073617	max 50	aluminium	w jednej osi in one axis	30
RADAN CT-DS050	07362	5905339073624	max 50	aluminium	brak no	

12 AC; 12 DC	MR-16	Gx5,3	30°	IP 20	
5+25		0,12	0,75		

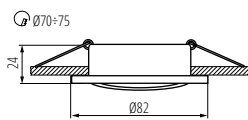

RADAN CT-DT0

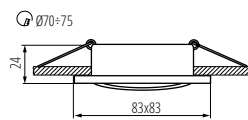

RADAN CT-DTL

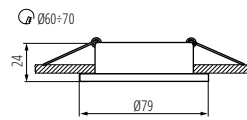

RADAN CT-DS0



TESON AL-DTL50

Kanlux TESON to proste oczka, które rozjaśnią każde pomieszczenie. Sami wybierzemy źródło światła jak i wersję oprawy - z regulacją lub nieruchomą.

Materiał obudowy: stop aluminium

Kanlux TESON are simple eyes which will light up each room. You can choose a source of light and a version of the holder on your own - with adjustment or immovable.

Enclosure material: aluminum alloy



TESON AL-DTL50



TESON AL-DSO50



TESON AL-DSL50

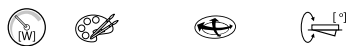

TESONAL-DTO50	07370	5905339073709	max 50	aluminium	w jednej osi in one axis	30
TESONAL-DTL50	07371	5905339073716	max 50	aluminium	w jednej osi in one axis	30
TESONAL-DSO50	07372	5905339073723	max 50	aluminium	brak no	
TESONAL-DSL50	07373	5905339073730	max 50	aluminium	brak no	

[V] 220-240 AC	[Hz] 50/60	PAR16	GU10	IP 20
5+25	0,75+2,5	0,5m	CE	ERAC

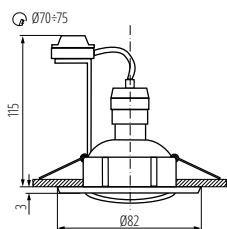

TESON AL-DTO

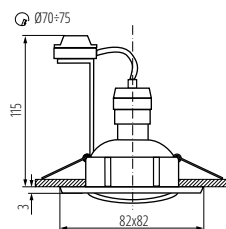

TESON AL-DTL

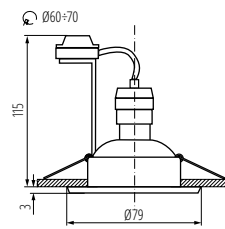

TESON AL-DSO

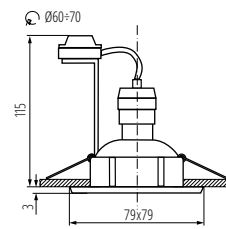

TESON AL-DSL

Kanlux TABO

OPRAWA SUFITOWA PUNKTOWA ► CEILING-MOUNTED SPOTLIGHT FITTING



TABO CT-AS02-AL



TABO CT-AS02-AL | 04701 | 5905339047014 max 35 aluminium brak | no

12 AC; 12 DC	MR-16	Gx5,3	III	↑	IP 20	
5+25	Ø70-75		0,12	0,75	0,5m	

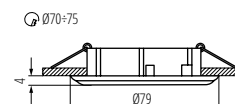

TABO

Kanlux AKRA

OPRAWA SUFITOWA PUNKTOWA ► CEILING-MOUNTED SPOTLIGHT FITTING



AKRA CT-DS14PS/N



AKRA CT-DS14PS/N | 04785 | 5905339047854 max 50 srebrny / nikiel | silver / nickel brak | no

12 AC; 12 DC	MR-16	Gx5,3	III	↑	IP 20	
5+25	Ø65-75		0,12	0,75	0,5m	

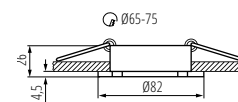

AKRA CT-DS14

Prosta aluminiowa oprawa w najbardziej neutralnym wzornictwie - to musi być Kanlux TABO. Sami dobierzemy do niej źródło światła z trzonkiem Gx5,3.

Materiał obudowy: stop aluminium

The simple aluminium holder in the most neutral design - it must be Kanlux TABO. You will choose a light source with the Gx5.3 light bulb base for it on your own.

Enclosure material: aluminum alloy

Sufitowa oprawa punktowa Kanlux AKRA to dekoracyjna oprawa punktowa o niecodziennym wzornictwie. Zastosować możemy w niej źródło ledowe z trzonkiem Gx5,3.

Materiał obudowy: stop aluminium

Kanlux AKRA ceiling spotlight fitting is a decorative fitting with an unusual design. We can use in it a LED source with Gx5,3 base.

Enclosure material: aluminum alloy

Kanlux

CEL

OPRAWA SUFITOWA PUNKTOWA ▶ CEILING-MOUNTED SPOTLIGHT FITTING

Kanlux CEL to oczko sufitowe wykonane z aluminium w kolorze matowego chromu. Oczko współpracuje z żarówkami o trzonku Gx4.

Materiał obudowy: stal

Kanlux CEL is a ceiling eye made of aluminium in the colour of mat chromium. The eye cooperates with bulbs with Gx4 light bulb base.

Enclosure material: steel



CEL CTC-5519-C/M



CEL CTC-5519-C/M | **02755** | 5905339027559 max 35 chrom satynowy | chrome Satin w jednej osi | in one axis 15

 12 AC; 12 DC	 MR-11	 Gx4	 15	 Ø60	 IP 20	 EAC	
 5÷25	 15	 Ø60	 0,5m				

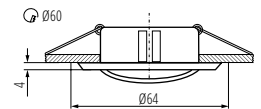

CEL CTC-5519-C/M



Kanlux QULES

OPRAWA SUFITOWA PUNKTOWA ► CEILING-MOUNTED SPOTLIGHT FITTING



QULES AC L-W



QULES AC L-C/M



QULES AC O-W



QULES AC O-C/M

IP
44/20

Sufitowe oczka Kanlux QULES to jedne z najpopularniejszych opraw o podwyższonym IP. Idealnie nadają się do zamontowania w łazience lub innych miejscach o podwyższonej wilgotności.

Materiał obudowy: stop aluminium

The Kanlux QULES ceiling eyes are one of the most popular holders with increased IP. They are ideal for mounting in a bathroom or in other places with increased humidity.

Enclosure material: aluminum alloy



QULES AC L-W	26300	5905339263001	max 35	biały white	brak no
QULES AC L-C/M	26301	5905339263018	max 35	chrom mat chrome matte	brak no
QULES AC O-W	26303	5905339263032	max 35	biały white	brak no
QULES AC O-C/M	26304	5905339263049	max 35	chrom mat chrome matte	brak no

[VI] 220-240 AC	[Hz] 50/60	GU10			IP 44/20
	-20+35	Ø71-74	0,5m	CE	EARC

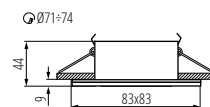

QULES AC L

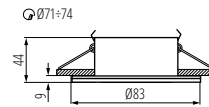

QULES AC O

Kanlux

MARIN

OPRAWA SUFITOWA PUNKTOWA ▶ CEILING-MOUNTED SPOTLIGHT FITTING



MARIN CT-S80-C



MARIN CT-S80-SN



MARIN CT-S80-AB

IP
44/20

Kanlux MARIN to niewielki szczelne oprawy sufitowe, których możemy użyć w miejscach o podwyższonej wilgoci. Swobodnie możemy je umieścić w łazience nad lustrem, w kuchni czy w pralni.

Materiał obudowy: stal

Kanlux MARIN means small and tight ceiling holders to be used in places with increased humidity. They can easily be placed in a bathroom above a mirror, in a kitchen or in a laundry.

Enclosure material: steel



MARIN CT-S80-C	04703	5905339047038	max 35	chrom chrome	brak no
MARIN CT-S80-SN	04704	5905339047045	max 35	nikiel mat nickel matte	brak no
MARIN CT-S80-AB	04710	5905339047106	max 35	mosiądz matowy matt brass	brak no

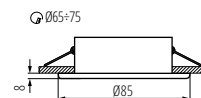

MARIN CT



ARGUS CT-2114-G

Kanlux ARGUS to najpopularniejsze i zarazem najprostsze w swojej formie oczko. Różnorodność wśród kształtów i kolorów sprawi, że każdy miłośnik klasyki znajdzie wśród nich coś dla siebie. Do oczek Kanlux ARGUS pasują żarówki z trzonkiem Gx5,3 (12V).

Materiał obudowy: stal

Kanlux ARGUS are the most popular and at the same time the simplest eye in its form. Diversity of shapes and colours will make each fan of classics find something for themselves among them. Bulbs with Gx5.3 (12V) light bulb base match the Kanlux ARGUS eyes.

Enclosure material: steel



ARGUS CT-2114-G	00300	5905339003003	max 50	złoty gold	brak no
ARGUS CT-2114-C	00301	5905339003010	max 50	chrom chrome	brak no
ARGUS CT-2114-W	00303	5905339003034	max 50	biały white	brak no
ARGUS CT-2115-G	00304	5905339003041	max 50	złoty gold	w jednej osi in one axis 15
ARGUS CT-2115-C	00305	5905339003058	max 50	chrom chrome	w jednej osi in one axis 15
ARGUS CT-2115-W	00307	5905339003072	max 50	biały white	w jednej osi in one axis 15
ARGUS CT-2117-C	00309	5905339003096	max 50	chrom chrome	w jednej osi in one axis 45
ARGUS CT-2117-W	00311	5905339003119	max 50	biały white	w jednej osi in one axis 45
ARGUS CT-2114-BR/M	00324	5905339003249	max 50	mosiądz matowy matt brass	brak no
ARGUS CT-2114-C/M	00325	5905339003256	max 50	chrom mat chrome matte	brak no
ARGUS CT-2114-AN	00327	5905339003270	max 50	miedź matowa matte copper	brak no
ARGUS CT-2114-GM	00328	5905339003287	max 50	grafitowy graphite	brak no
ARGUS CT-2115-BR/M	00330	5905339003300	max 50	mosiądz matowy matt brass	w jednej osi in one axis 15
ARGUS CT-2115-C/M	00331	5905339003317	max 50	chrom mat chrome matte	w jednej osi in one axis 15
ARGUS CT-2115-AN	00333	5905339003331	max 50	miedź matowa matte copper	w jednej osi in one axis 15
ARGUS CT-2115-GM	00334	5905339003348	max 50	grafitowy graphite	w jednej osi in one axis 15
ARGUS CT-2117-BR/M	00336	5905339003362	max 50	mosiądz matowy matt brass	w jednej osi in one axis 45
ARGUS CT-2117-C/M	00337	5905339003379	max 50	chrom mat chrome matte	w jednej osi in one axis 45
ARGUS CT-2117-GM	00340	5905339003409	max 50	grafitowy graphite	w jednej osi in one axis 45

12 AC; 12 DC	MR-16		Gx5,3	IP 20		5+25
	[m] 0,12	[mm] 0,75	[m] 0,5m			
						A B C D E

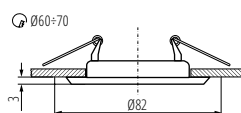

ARGUS CT-2114

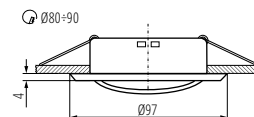

ARGUS CT-2115

Kanlux
ARGUS

OPRAWA SUFITOWA PUNKTOWA ▶ CEILING-MOUNTED SPOTLIGHT FITTING



ARGUS CT-2114-C



ARGUS CT-2114-W



ARGUS CT-2114-C/M



ARGUS CT-2114-AN



ARGUS CT-2114-BR/M



ARGUS CT-2114-GM



ARGUS CT-2115-C



ARGUS CT-2115-W



ARGUS CT-2115-C/M



ARGUS CT-2115-AN



ARGUS CT-2115-BR/M



ARGUS CT-2115-GM



ARGUS CT-2115-G



ARGUS CT-2117-C



ARGUS CT-2117-W



ARGUS CT-2117-C/M



ARGUS CT-2117-BR/M



ARGUS CT-2117-GM

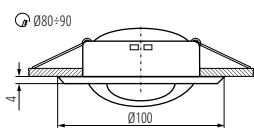

ARGUS CT-2117



Kanlux ALOR

PIERŚCIEŃ OPRAWY PUNKTOWEJ ► RING FOR SPOTLIGHT FITTINGS



ALOR DTO-B



ALOR DSL-W



ALOR DSL-B



ALOR DSL-C



ALOR DSL-C/M



ALOR DTL-B



ALOR DSO-B



Kanlux ALOR to bogata kolorystycznie paleta jednych z najbardziej popularnych oczek sufitowych o średnicy 8,3 cm. Oczka nie posiadają w komplecie oprawki ceramicznej. Możemy tu zastosować oprawkę, która będzie pasować do trzonka GU10 lub Gx5,3, co pozwoli nam na zastosowanie źródeł światła dopasowanych do przygotowanej instalacji.

Materiał obudowy: stal

Kanlux ALOR is a palette rich in terms of colours of one of the most popular ceiling eyes with diameter of 8.3 cm. The eyes do not have a ceramic frame in the set. You can use a frame here which will match the GU10 or Gx5.3 light bulb base, which will allow us to use light sources adapted to a prepared installation.

Enclosure material: steel



ALOR DSL-W	26726	5905339267269	max 35	biały mat matte white	brak no
ALOR DSL-B	26727	5905339267276	max 35	czarny mat black matt	brak no
ALOR DSL-C	26728	5905339267283	max 35	chrom chrome	brak no
ALOR DSL-C/M	26729	5905339267290	max 35	chrom mat chrome matte	brak no
ALOR DTL-B	26732	5905339267320	max 35	czarny mat black matt	w jednej osi in one axis 30
ALOR DSO-B	26791	5905339267917	max 35	czarny mat black matt	brak no
ALOR DTO-B	26796	5905339267962	max 35	czarny mat black matt	w jednej osi in one axis 30

[V] 12 AC; 12 DC; 220-240 AC	 MR16/PAR16	 Gx5,3/GU10	 5+25	 0,5m	 CE	 Kanlux
IP 20						

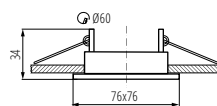

ALOR DSL

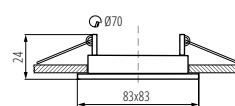

ALOR DTL

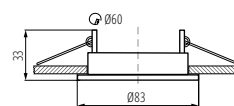

ALOR DSO

Kanlux DELE

OPRAWA SUFITOWA PUNKTOWA ► CEILING-MOUNTED SPOTLIGHT FITTING



DELE AL-204-C/M



Kanlux DELE to klasyczne oczka. Charakteryzuje je szeroki pierścień dekoracyjny. Cała seria utrzymana jest w kolorze matowy chrom, znajdziemy w niej oczka nieruchome jak i te z możliwością ustawienia kierunku padania światła.

Materiał obudowy: stal

Kanlux DELE are classic eyes. They are characterized by a wide decorative ring. The whole series is in the colour of mat chromium with immovable eyes and eyes with a possibility of setting the direction of light.

Enclosure material: steel



DELE AL-204-C/M	00913	5905339009135	max 50	chrom mat chrome matte	brak no
DELE AL-205-C/M	00923	5905339009234	max 50	chrom mat chrome matte	w jednej osi in one axis 20

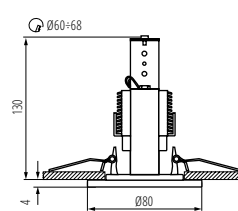

DELE AL-204

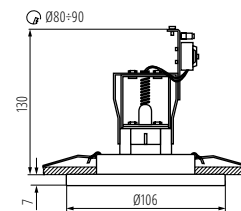

DELE AL-205

[VI]	PAR16	GU10/G210	IP 20	
220-240 AC	5+25	0,75+2,5	0,5m	

Kanlux DANERA

OPRAWA SUFITOWA PUNKTOWA ► CEILING-MOUNTED SPOTLIGHT FITTING



DANERA CT-DTL35-SC

Kanlux DANERA to klasyczne oczko z możliwością regulacji kierunku świecenia. Kolor oczka to satynowy chrom.

Materiał obudowy: stop metali niekorodujących

Kanlux DANERA is a classic eye with a possibility of adjusting the direction of light. Colour of the eye is satin chromium.

Enclosure material: non-corrosive metals alloy



DANERA CT-DTL35-SC	08666	5905339086662	max 35	chrom mat chrome matte	w jednej osi in one axis 15
--------------------	--------------	---------------	--------	--------------------------	-------------------------------

[VI]	MR-11	Gx5,3	IP 20	
12 AC; 12 DC	5+25	0,12	0,75	

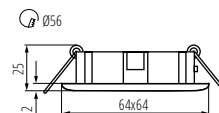

DANERA CT-DTL35-SC

Kanlux ULKE

OPRAWA SUFITOWA PUNKTOWA ► CEILING-MOUNTED SPOTLIGHT FITTING



ULKE CT-2119-C



ULKE CT-2113-C



ULKE CT-2119-C/M



ULKE CT-2113-C/M

Kanlux ULKE to rodzina prostych w swojej formie, różnorodnych opraw punktowych o bardzo szerokich możliwościach zastosowania.

Materiał obudowy: stal

Kanlux ULKE is a family of simple in their form, diverse spot-beam holders with very broad possibilities of use.

Enclosure material: steel



ULKE CT-2119-C	00313	5905339003133	max 35	chrom chrome	w jednej osi in one axis	15
ULKE CT-2113-C	00321	5905339003218	max 35	chrom chrome	brak no	
ULKE CT-2119-C/M	00349	5905339003492	max 35	chrom mat chrome matte	w jednej osi in one axis	15
ULKE CT-2113-C/M	00355	5905339003553	max 35	chrom mat chrome matte	brak no	

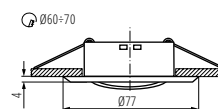

ULKE CT-2119

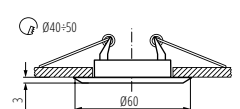

ULKE CT-2113

Kanlux BASK

OPRAWA SUFITOWA PUNKTOWA ► CEILING-MOUNTED SPOTLIGHT FITTING



BASK CTC-5515-MPC/N



BASK CTC-5515-SN/N



BASK CTC-5514-MPC/N



BASK CTC-5514-SN/N

Kanlux BASK to proste oczka z delikatnym motywem ozdobnym. Ich atutem jest kolorystyka (na przykład satynowy nikiel połączony ze złotym). Do oczek Kanlux BASK pasują żarówki z trzonkiem Gx5,3 (12V).

Materiał obudowy: stop aluminium

Kanlux BASK are simple eyes with a delicate decorative motif. Colour scheme is their asset (for example, satin nickel combined with gold). Bulbs with Gx5.3 (12V) light bulb base match the Kanlux BASK eyes.

Enclosure material: aluminum alloy



BASK CTC-5515-MPC/N	02804	5905339028044	max 50	chrom satynowy / nikiel satin chromium / nickel	w jednej osi in one axis	15
BASK CTC-5515-SN/N	02806	5905339028068	max 50	nikiel mat / nikiel nickel matte / nickel	w jednej osi in one axis	15
BASK CTC-5514-MPC/N	02814	5905339028143	max 50	chrom satynowy / nikiel satin chromium / nickel	brak no	
BASK CTC-5514-SN/N	02816	5905339028167	max 50	nikiel mat / nikiel nickel matte / nickel	brak no	

12 AC; 12 DC	MR-16	Gx5,3		IP 20	
5+25	0,12	0,75	0,5m	CE	EAC

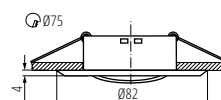

BASK CTC-5515

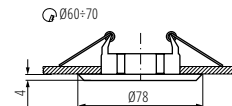

BASK CTC-5514

Kanlux HORN

OPRAWA SUFITOWA PUNKTOWA ► CEILING-MOUNTED SPOTLIGHT FITTING



HORN CTC-3114-SN/G



HORN CTC-3114-SN/N



HORN CTC-3114-PS/G



HORN CTC-3114-GM/N



HORN CTC-3115-SN/G



HORN CTC-3115-SN/N



HORN CTC-3115-PS/G



HORN CTC-3115-GM/N



Bardzo duża rodzina popularnych oczek Kanlux HORN to przekrój; od klasycznych modeli po odważne zestawienia kolorystyczne. Wśród nich każdy wybierze swoje ulubione.

Materiał obudowy: stal



A very large family of the popular Kanlux HORN eyes is a range of classic models and a brave colour compilation. Everyone will choose the favourite one from among them.

Enclosure material: steel



HORN CTC-3114-SN/G	02820	5905339028204	max 50	nikiel mat / złoty nickel matte / gold	brak no
HORN CTC-3114-SN/N	02821	5905339028211	max 50	złoty matowy / nikiel matte gold / nickel	brak no
HORN CTC-3114-PS/G	02822	5905339028228	max 50	perłowy / złoty pearl / gold	brak no
HORN CTC-3114-GM/N	02824	5905339028242	max 50	grafitowy / nikiel graphite / nickel	brak no
HORN CTC-3115-SN/G	02830	5905339028303	max 50	nikiel mat / złoty nickel matte / gold	w jednej osi in one axis 15
HORN CTC-3115-SN/N	02831	5905339028310	max 50	nikiel mat / nikiel nickel matte / nickel	w jednej osi in one axis 15
HORN CTC-3115-PS/G	02832	5905339028327	max 50	perłowo biały / złoty pearl white / gold	w jednej osi in one axis 15
HORN CTC-3115-GM/N	02834	5905339028341	max 50	grafitowy / nikiel graphite / nickel	w jednej osi in one axis 15

12 AC; 12 DC	MR-16	Gx5,3	5°	IP 20	
5+25	0,12	0,75	0,5m		

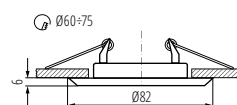

HORN CTC-3114

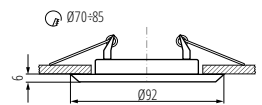

HORN CTC-3115

Kanlux CANTA

OPRAWA SUFITOWA PUNKTOWA ► CEILING-MOUNTED SPOTLIGHT FITTING



CANTA CTX-DS20



CANTA CTX-DS20 | 19610 | 5905339196101 | max 20 | chrom / transparentny | chrome / transparent

12 AC; 12 DC	JC		G4			IP 20
	5+25	Ø53-85	0,5m			



Elegancka w formie Kanlux CANTA w kolorze transparentnego chromu powstała z nieszablonego połączenia szkła i stali. Stanowi ona wyjątkową ozdobę pomieszczenia. Posiada również dodatkowy atut jakim jest unikalny sposób rozsyłu światła.

Materiał obudowy: stal, szkło

Kanlux CANTA elegant in its form in the colour of transparent chromium was made of unconventional combination of glass and steel. It is an exceptional ornament of a room. It also has an additional asset i.e. a unique way of distributing light.

Enclosure material: steel, glass

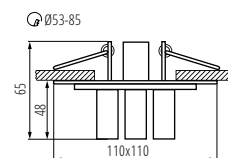

CANTA CTX

Kanlux ELLI

OPRAWA SUFITOWA PUNKTOWA ► CEILING-MOUNTED SPOTLIGHT FITTING



ELLI CTX-DS20



ELLI CTX-DS20 | 18410 | 5905339184108 | max 20 | chrom / transparentny | chrome / transparent | brak | no

12 AC; 12 DC	JC		G4			IP 20
	5+25	Ø55-60	0,5m			



Kanlux ELLI to ciekawa w kształcie oprawa, która swoją nietypową, geometryczną budową przywodzi na myśl oszlifowany diament. Połączenie szkła oraz metalu nadaje lampie szlachetności i czyni z niej eleganckie oświetlenie ozdobne.

Materiał obudowy: stop metali niekorodujących

Kanlux ELLI is a holder interesting in terms of shape which makes you think of a cut diamond thanks to its untypical, geometrical construction. Combination of glass and metal gives nobleness to the lamp and makes it elegant decorative lighting.

Enclosure material: non-corrosive metals alloy

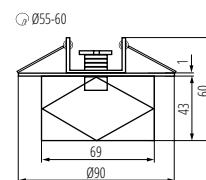

ELLI CTX

Kanlux DINO

OPRAWA SUFITOWA PUNKTOWA ► CEILING-MOUNTED SPOTLIGHT FITTING



DINO CTX-DS02G/B-C



DINO CTX-DS02G/B-C | **02576** | 5905339025760 max 50 chrom | chrome brak | no

[VI] 12 AC; 12 DC	MR-16	Gx5,3	IP 20	House icon
5+25	Ø60-70	0,12	0,75	0,5m

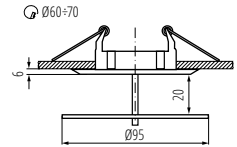

DINO CTX

Kanlux DINO to okrągła oprawa, która wyróżnia się ciekawym wzornictwem. Nietypowe połączenie aluminium z dystansowo umieszczoną, otwartą z boków, szklaną osłoną stanowi niespotykany element dekoracyjny, który doda ciekawego efektu każdemu pomieszczeniu, w którym się znajdzie.

Materiał obudowy: stop aluminium

Kanlux DINO is a round holder which is distinguished by interesting design. Untypical combination of aluminium with a glass shield placed at a distance, open from its sides, is a unique decorative element which will add an interesting effect to each room where it is located.

Enclosure material: aluminum alloy

Kanlux NOMA

OPRAWA SUFITOWA PUNKTOWA ► CEILING-MOUNTED SPOTLIGHT FITTING



NOMA CTX-DS10G/B-C



NOMA CTX-DS10G/B-C | **02566** | 5905339025661 max 50 chrom | chrome brak | no

[VI] 12 AC; 12 DC	MR-16	Gx5,3	IP 20	House icon
5+25	Ø60-70	0,12	0,75	0,5m

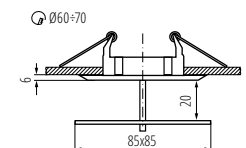

NOMA CTX

Kanlux NOMA to kwadratowa oprawa, która wyróżnia się ciekawym wzornictwem. Nietypowe połączenie aluminium z dystansowo umieszczoną, otwartą z boków, szklaną osłoną stanowi niespotykany element dekoracyjny, który doda ciekawego efektu każdemu pomieszczeniu, w którym się znajdzie.

Materiał obudowy: stop aluminium

Kanlux NOMA is a square holder which is distinguished by interesting design. Untypical combination of aluminium with a glass shield placed at a distance, open from its sides, is a unique decorative element which will add an interesting effect to each room where it is located.

Enclosure material: aluminum alloy

Kanlux RODOS

OPRAWA SUFITOWA PUNKTOWA ► CEILING-MOUNTED SPOTLIGHT FITTING



Kanlux RODOS to ozdobne oprawy sufitowe. Wzór na pierścieniu przywodzi na myśl charakterystyczne, greckie malowidła.

Materiał obudowy: stop aluminium

Kanlux RODOS are decorative ceiling holders. The pattern on the ring makes you think of characteristic, Greek paintings.

Enclosure material: aluminum alloy



RODOS CT-DS09-AB



RODOS CT-DS09-AB	04685	5905339046857	max 50	mosiądz patynowany patinated brass	brak no
RODOS CT-DT09-AB	04688	5905339046888	max 50	mosiądz patynowany patinated brass	w jednej osi in one axis 30

12 AC; 12 DC	MR-16	Gx5,3	III	20	IP 20
5÷25	0,12	0,75	0,5m	CE	EAC

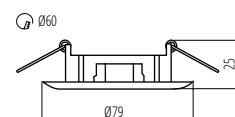

RODOS CT-DS09

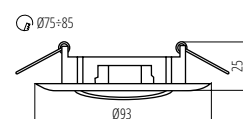

RODOS CT-DT09

Kanlux URTICA

OPRAWA SUFITOWA PUNKTOWA ► CEILING-MOUNTED SPOTLIGHT FITTING



Ozdobna oprawa Kanlux URTICA wyróżnia się bogatymi, odważnymi wręcz zdobieniami na pierścieniu. Oprawa wymaga przemyślanego zestawiania z wnętrzem, w którym chcemy ją umieścić. Jednak efekt, który dzięki niej uzyskujemy może być naprawdę wyjątkowy.

Materiał obudowy: stop aluminium

The Kanlux URTICA decorative holder is distinguished by rich, even brave decors on the ring. The holder requires a well-thought-of combination with interiors where you want to place it. However, the effect generated by it can be really exceptional.

Enclosure material: aluminum alloy



URTICA CT-DT050-AB



URTICA CT-DT050-AB	19550	5905339195500	max 50	mosiądz patynowany patinated brass	w jednej osi in one axis 30
--------------------	--------------	---------------	--------	--------------------------------------	-------------------------------

12 AC; 12 DC	MR-16	Gx5,3	III	20	IP 20
5÷25	Ø75-80	0,12	0,75	0,5m	CE

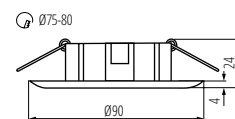

URTICA CT

Kanlux

ELSE

OPRAWA SUFITOWA PUNKTOWA ► CEILING-MOUNTED SPOTLIGHT FITTING



Kanlux ELSE to minimalistyczna, niewielka oprawa i średnicy 30mm. Źródło światła stanowi żarówka typu JC.

Materiał obudowy: stop aluminium, szkło

Kanlux ELSE is a minimalistic, small holder with diameter of 30mm. JC type bulb is a source of light.

Enclosure material: aluminum alloy, glass



ELSE CT-2116C-C



ELSE CT-2116C-C	00821	5905339008213	max 10	chrom chrome
ELSE CT-2116C-C/M	00825	5905339008251	max 10	chrom mat chrome matte

IV 12 AC; 12 DC	JC		G4			IP 20
	 5+25	 Ø25		 0,5m		

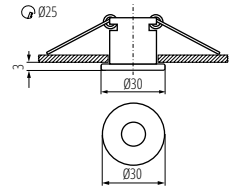

ELSE CT

Kanlux

IMBER

OPRAWA AKCENTOWA LED ► LED MIRROR LIGHT FITTING



IMBER LED NW



IMBER LED NW	23520	5905339235206	1	aluminium	40	105	4000
IMBER LED CW	23521	5905339235213	1	aluminium	40	105	6500

IV 12 AC; 12 DC		 [h] 30000	 ≤ 60 MacAdam	 Ra ≥ 80			IP 65
	 5+25			 0,1m			



Kanlux IMBER LED to wodoszczelna oprawa akcentowa do wbudowania. Jednym z jej atutów jest niska temperatura pracy, dzięki czemu może być bez przeszkód mocowana również w drewnie. Unikatowa konstrukcja oprawy to równomierna emisja światła, a zastosowane tu diody LED gwarantują dużą energooszczędność. Oprawa Kanlux IMBER LED to doskonały pomysł na podświetlenie kabin prysznicowych czy podbitek dachowych na zewnątrz domu.

Materiał obudowy: stop aluminium

Materiał klosza: tworzywo sztuczne

Kanlux IMBER LED is a waterproof holder intended for building in. Low temperature of work is one of its assets, thanks to which it can be easily mounted in wood as well. The unique structure of the holder means a regular emission of light and LED diodes used here guarantee high energy efficiency. The Kanlux IMBER LED holder is a perfect idea to highlight shower baths or outdoor soffits outside a house.

Enclosure material: aluminum alloy

Lampshade material: plastic

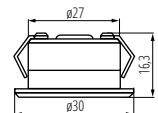

IMBER LED

Kanlux OYO

AKCENT ŚWIETLNY LED ► LED MIRROR LIGHTS

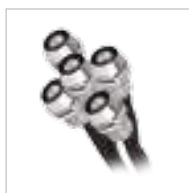

OYO 2LED-CW

Kanlux OYO to punktowe akcenty świetlne, które zastosujemy jako oświetlenie ozdobne. Niewielkie punkty świetlne pomogą nam zrealizować śmiałe projekty oświetleniowe również w saunach i łazienkach dzięki wysokiej szczelności - IP68.

OYO 2LED-CW w komplecie 2 sztuki

OYO 5LED-CW w komplecie 5 sztuk

Materiał obudowy: metal, tworzywo sztuczne

Kanlux OYO are spot-beam light accents to be used as decorative lighting. The small light points will help us to implement brave lighting projects also in saunas and bathrooms thanks to high tightness - IP68.

OYO 2LED-CW, 2 pcs included

OYO 5LED-CW, 5 pcs included

Enclosure material: Metal, plastic



OYO 2LED-CW	08120	5905339081209	0,22	aluminium	15	6000-8000
OYO 5LED-CW	08121	5905339081216	0,22	chrom chrome	15	6000-8000

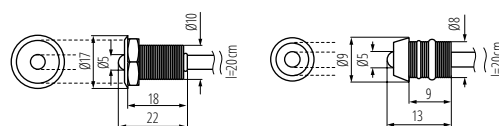
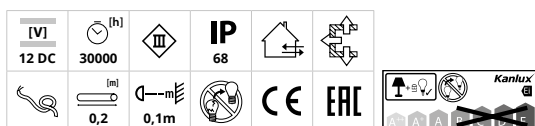

OYO 2LED

OYO 5LED

Kanlux HAXA

OPRAWA AKCENTOWA LED ► LED MIRROR LIGHT FITTING



HAXA-DSO POWER LED-B



Ścienne-sufitowa oprawa punktowa POWER LED Kanlux HAXA to niewielkie oczko, które zastosujemy jako oświetlenie uzupełniające.

Do prawidłowego działania wymagany zasilacz elektroniczny o prądzie stałym 350mA, np. ADI 350 lub RICO dostępny w ofercie Kanlux

Materiał obudowy: stop aluminium

Materiał klosza: tworzywo sztuczne

The wall and ceiling spot-beam holder - POWER LED Kanlux HAXA is a small eye to be used as additional lighting.

An electronic 350-mA DC power supply unit is required for proper functioning, e.g. ADI 350 or RICO available from Kanlux

Enclosure material: aluminum alloy

Lampshade material: plastic



HAXA-DSO POWER LED-B	08103	5905339081032	1	aluminium	15	2700-3200
----------------------	--------------	---------------	---	-----------	----	-----------

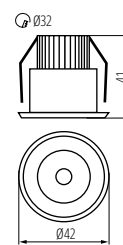
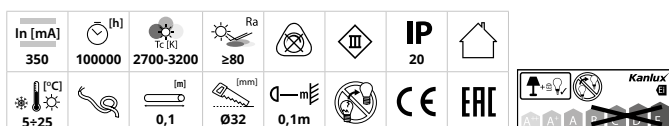

HAXA-DSO

Kanlux ASIL

OPRAWA ŚCIENNA ► WALL-MOUNTED LIGHT FITTING



ASIL G9 W-B



ASIL G9 W-GR



ASIL G9 W-W

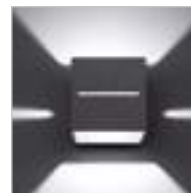

Kanlux ASIL to kinkiety, które dzięki swojemu kształtowi tworzą bardzo ciekawy efekt świetlny na ścianie. Światło rozchodzi się nie tylko do góry i na dół, ale również wydobywa się przez specjalnie zaprojektowaną szczelinę. Dzięki oprawie Kanlux ASIL stworzymy przytulny nastrój w domu, wnętrzu hotelowym lub uzupełnimy oświetlenie w restauracji czy kawiarni.

Materiał obudowy: stop aluminium

Kanlux ASIL are wall lamps which, thanks to their shape, create a very interesting light effect on a wall. Light does not only part upwards and downwards but it is also emitted through a specially designed slit. Thanks to the Kanlux ASIL holder, you can create a cosy atmosphere at home, in hotel interiors or you can complete lighting in a restaurant or coffee shop.

Enclosure material: aluminum alloy



ASIL G9 W-B	27020	5905339270207	max 40	czarny black
ASIL G9 W-GR	27021	5905339270214	max 40	szary grey
ASIL G9 W-W	27022	5905339270221	max 40	biały white

[V] 220-240 AC	[Hz] 50/60	G9	G9	Light bulb icon	Grounding symbol	IP 20	House icon
5+25	Light bulb icon	Light bulb icon	Light bulb icon	0,5m	CE	ERL	Kanlux logo

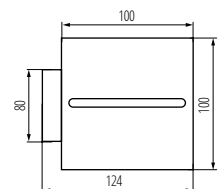

ASIL G9

Kanlux KASSI

OPRAWA ŚCIENNA ► WALL-MOUNTED LIGHT FITTING



KASSI G9 L-W



KASSI G9 O-W



Kanlux KASSI to szklany kinkiet w kształcie walca lub sześcianu. Jego wyjątkowość tkwi w prostocie. Matowe, białe szkło połączone z aluminium podkreśli estetykę każdego wnętrza niezależnie od tego czy będzie ono urządzone w sposób nowoczesny czy klasyczny.

Materiał obudowy: stop aluminium, szkło

Kanlux KASSI is a glass wall lamp in the shape of a cylinder or cube. Simplicity is the essence of its uniqueness. Mat, white glass combined with aluminium will emphasize the aesthetics of each interior regardless of whether it is furnished in a modern or classic style.

Enclosure material: aluminum alloy, glass



KASSI G9 L-W	27010	5905339270108	max 40	biały white
KASSI G9 O-W	27011	5905339270115	max 40	biały white

[V] 220-240 AC	[Hz] 50/60	G9	G9			IP 20		
 5+25		 0,75-2,5	 0,5m					

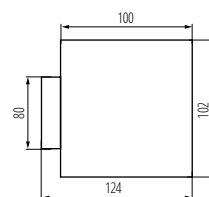

KASSI G9 L

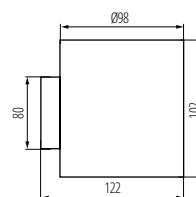

KASSI G9 O

Kanlux ASTEN

OPRAWA ŚCIENNA LED IP44 ► WALL-MOUNTED LED LIGHT FITTING, IP44



Kanlux ASTEN LED jest liniową oprawą ścienną, którą zastosujesz w sypialni, garderobie, ale również (dzięki IP równemu 44) w miejscach o podwyższonej wilgotności. Bez obaw możesz zamontować ją nad lustrem w łazience. Lampa posiada wbudowane źródła światła oparte na diodach LED SMD, których trwałość wynosi przynajmniej 25000 godzin.

Materiał obudowy: stop aluminium
Materiał klosza: tworzywo sztuczne

Kanlux ASTEN LED is a linear wall mount to be used in bedrooms, wardrobe as well as (thanks to IP equal to 44) in places with increased humidity. It can be mounted without fear above a mirror in a bathroom. The lamp has built-in light sources based on LED SMD diodes the durability of which comes to at least 25,000 hours.

Enclosure material: aluminum alloy
Lampshade material: plastic



ASTEN LED IP44 8W-NW



ASTEN LED IP44 12W-NW



ASTEN LED IP44 15W-NW



ASTEN LED IP44 8W-NW	26680	5905339266804	8	biały / chrom white / chrome	450	4000
ASTEN LED IP44 12W-NW	26681	5905339266811	12	biały / chrom white / chrome	770	4000
ASTEN LED IP44 15W-NW	26682	5905339266828	15	biały / chrom white / chrome	970	4000

[V] 220-240 AC	[Hz] 50/60		 ≥15000	 25000	 ≤6° MacAdam	 Ra ≥80				
IP 44		 5+30		 0,75±1,5	 0,1m					

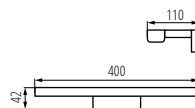

ASTEN LED IP44 8W

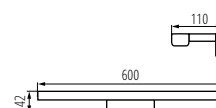

ASTEN LED IP44 12W

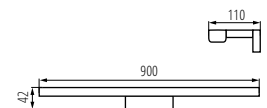

ASTEN LED IP44 15W

Kanlux

PESSA

OPRAWA ŚCIENNA LED IP44 ► WALL-MOUNTED LED LIGHT FITTING, IP44



PESSA LED IP44 9W-NW



PESSA LED IP44 9W-WW	27530	5905339275301	9	biały white	700	3000
PESSA LED IP44 9W-NW	27531	5905339275318	9	biały white	700	4000
PESSA LED IP44 17W-WW	27532	5905339275325	17	biały white	1400	3000
PESSA LED IP44 17W-NW	27533	5905339275332	17	biały white	1400	4000

[V] 220-240 AC	[Hz] 50/60			 ≥15000	 20000	 ≤6x MacAdam	 ≥80			
IP 44		 5÷25		 0,75÷1,5	 0,5m					

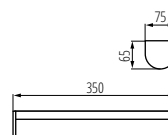

PESSA LED IP44 9W

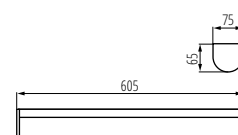

PESSA LED IP44 17W

Kalux PESSA LED to liniowa oprawa, która cechuje się szczelnością na poziomie IP44. Z powodzeniem rozświetlimy nią łazienki lub pokoje kąpielowe.

Materiał obudowy: stop aluminium, tworzywo sztuczne

Materiał klosza: tworzywo sztuczne

Kanlux PESSA LED is a linear fixture, characterised by the IP44 protection classification. You can successfully brighten up bathrooms or washrooms with it.

Enclosure material: aluminum alloy, plastic

Lampshade material: plastic

Kanlux

ROLSO

OPRAWA ŚCIENNA LED IP44 ► WALL-MOUNTED LED LIGHT FITTING, IP44



ROLSO LED IP44 15W-NW



ROLSO LED IP44 15W-WW	26700	5905339267009	15	biały / chrom white / chrome	1080	4000
ROLSO LED IP44 20W-NW	26701	5905339267016	20	biały / chrom white / chrome	1440	4000

[V] 220-240 AC	[Hz] 50/60			 ≥15000	 25000	 ≤6x MacAdam	 ≥80			
IP 44		 5÷30		 0,75÷1,5	 0,1m					

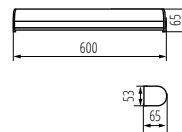

ROLSO LED IP44 15W

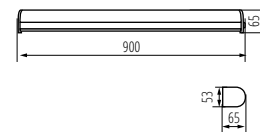

ROLSO LED IP44 20W

Kanlux ROLSO to nowoczesna oprawa domowa LED, której dodatkowym atutem jest subtelny design, który doskonale współgra zwłaszcza z nowoczesnymi wnętrzami. Oprawa ta świetnie sprawdzi się jako oświetlenie łazienkowe, dzięki współczynnikowi IP44.

Materiał obudowy: stop aluminium

Materiał klosza: tworzywo sztuczne

Kanlux ROLSO is a modern LED home holder whose additional asset is subtle design which perfectly cooperates in particular with modern interiors. This holder will work well as lighting of bathrooms, thanks to the IP44 coefficient.

Enclosure material: aluminum alloy

Lampshade material: plastic

Kanlux APUS

OPRAWA PRZYSCHODOWA LED ► STAIRCASE LED LIGHT FITTING



APUS LED, APUS LED AC



APUS LED W



APUS LED PIR



Kanlux APUS to nowoczesny design połączony z atrakcyjnym efektem świecenia. To doskonały pomysł na podświetlenie schodów i korytarzy lub na zaakcentowanie wystroju pomieszczeń. Unikatowa konstrukcja oprawy zapewnia równomierną emisję światła. Wersja AC wyposażona jest w zasilacz 230V, który mieści się w puszcze, a wersja PIR w czujnik ruchu.

Oprawa przystosowana do montażu w puszkach elektroinstalacyjnych Ø 60.

Materiał obudowy: stal nierdzewna szlifowana, tworzywo sztuczne

Kanlux APUS means modern design combined with an attractive effect of lighting. It is a perfect idea to highlight stairs and corridors or to emphasize decor of rooms. The unique structure of the holders ensures even emission of light. The AC version is equipped with 230V power supply unit which fits into a box and the PIR version is equipped with a motion sensor.

The fitting is suitable for mounting in Ø 60 junction boxes.

Enclosure material: polished stainless steel, plastic



Model	Code	Part No.	Voltage	Power	Material	Finish	Height	Width
APUS LED WW	23106	5905339231062	12 DC	0,8	stal szcztokowana	brushed steel	13	3000
APUS LED CW	23107	5905339231079	12 DC	0,8	stal szcztokowana	brushed steel	15	6500
APUS LED AC-WW	23800	5905339238009	220-240 AC	1,3	stal szcztokowana	brushed steel	13	3000
APUS LED AC-CW	23801	5905339238016	220-240 AC	1,3	stal szcztokowana	brushed steel	15	6500
APUS LED W-WW	26840	5905339268402	12 DC	0,8		biały white	13	3000
APUS LED W-CW	26841	5905339268419	12 DC	0,8		biały white	15	6500
APUS LED PIR WW	27370	5905339273703	12 DC	0,8	stal szcztokowana	brushed steel	13	3000
APUS LED PIR CW	27371	5905339273710	12 DC	0,8	stal szcztokowana	brushed steel	15	6500

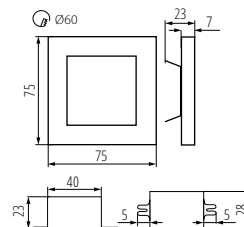

APUS LED; APUS LED AC; APUS LED W;

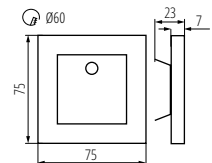

APUS LED PIR



TERRA LED; TERRA LED AC



TERRA MINI LED



TERRA LED W



TERRA LED PIR



Kanlux TERRA to nowoczesny design połączony z atrakcyjnym efektem świecenia. To doskonały pomysł na podświetlenie schodów i korytarzy lub na zaakcentowanie wystroju pomieszczeń. Unikatowa konstrukcja oprawy zapewnia równomierną emisję światła. Wersja AC wyposażona jest w zasilacz 230V, który mieści się w puszcze, a wersja PIR w czujnik ruchu.

Oprawa przystosowana do montażu w puszkach elektroinstalacyjnych Ø 60.

Materiał obudowy: stal nierdzewna szlifowana, tworzywo sztuczne

Kanlux TERRA means modern design combined with an attractive effect of lighting. It is a perfect idea to highlight stairs and corridors or to emphasize decor of rooms. The unique structure of the holders ensures even emission of light. The AC version is equipped with 230V power supply unit which fits into a box and the PIR version is equipped with a motion sensor.

The fitting is suitable for mounting in Ø 60 junction boxes.

Enclosure material: polished stainless steel, plastic



	[V]	[W]		[lm]	Tc/Tki	
TERRA LED WW	23102	5905339231024	12 DC	0,8	stal szcztokowana brushed steel	13 3000
TERRA MINI LED WW	23103	5905339231031	12 DC	0,8	stal szcztokowana brushed steel	13 3000
TERRA LED CW	23104	5905339231048	12 DC	0,8	stal szcztokowana brushed steel	15 6500
TERRA MINI LED CW	23105	5905339231055	12 DC	0,8	stal szcztokowana brushed steel	15 6500
TERRA LED AC-WW	23806	5905339238061	220-240 AC	1,3	stal szcztokowana brushed steel	13 3000
TERRA LED AC-CW	23807	5905339238078	220-240 AC	1,3	stal szcztokowana brushed steel	15 6500
TERRA LED W-WW	26842	5905339268426	12 DC	0,8	biały white	13 3000
TERRA LED W-CW	26843	5905339268433	12 DC	0,8	biały white	15 6500
TERRA LED PIR WW	27372	5905339273727	12 DC	0,8	stal szcztokowana brushed steel	13 3000
TERRA LED PIR CW	27373	5905339273734	12 DC	0,8	stal szcztokowana brushed steel	15 6500

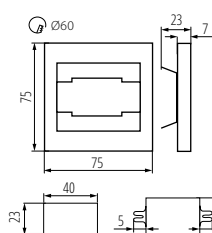

TERRA MINI LED

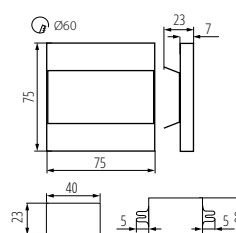

TERRA LED, TERRA LED AC; TERRA LED W

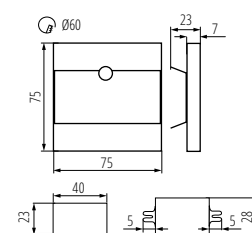

TERRA LED PIR

Kanlux SABIK

OPRAWA PRZYSCHODOWA LED ► STAIRCASE LED LIGHT FITTING



SABIK LED; SABIK LED AC



SABIK MINI LED



SABIK LED PIR



Kanlux SABIK to nowoczesny design połączony z atrakcyjnym efektem świecenia. To doskonały pomysł na podświetlenie schodów i korytarzy lub na zaakcentowanie wystroju pomieszczeń. Unikatowa konstrukcja oprawy zapewnia równomierną emisję światła. Wersja AC wyposażona jest w zasilacz 230V, który mieści się w puszcze, a wersja PIR w czujnik ruchu.

Oprawa przystosowana do montażu w puszkach elektroinstalacyjnych Ø 60.
Materiał obudowy: stal nierdzewna szlifowana, tworzywo sztuczne

Kanlux SABIK means modern design combined with an attractive effect of lighting. It is a perfect idea to highlight stairs and corridors or to emphasize decor of rooms. The unique structure of the holders ensures even emission of light. The AC version is equipped with 230V power supply unit which fits into a box and the PIR version is equipped with a motion sensor.

The fitting is suitable for mounting in Ø 60 junction boxes.

Enclosure material: polished stainless steel, plastic



	[V]	[W]						
SABIK LED WW	23108	5905339231086	12 DC	0,8	stal szcztokowana	brushed steel	13	3000
SABIK MINI LED WW	23109	5905339231093	12 DC	0,8	stal szcztokowana	brushed steel	13	3000
SABIK LED CW	23110	5905339231109	12 DC	0,8	stal szcztokowana	brushed steel	15	6500
SABIK MINI LED CW	23111	5905339231116	12 DC	0,8	stal szcztokowana	brushed steel	15	6500
SABIK LED AC-WW	23802	5905339238023	220-240 AC	1,3	stal szcztokowana	brushed steel	13	3000
SABIK LED AC-CW	23803	5905339238030	220-240 AC	1,3	stal szcztokowana	brushed steel	15	6500
SABIK LED PIR WW	27374	5905339273741	12 DC	0,8	stal szcztokowana	brushed steel	13	3000
SABIK LED PIR CW	27375	5905339273758	12 DC	0,8	stal szcztokowana	brushed steel	15	6500

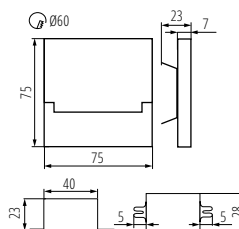
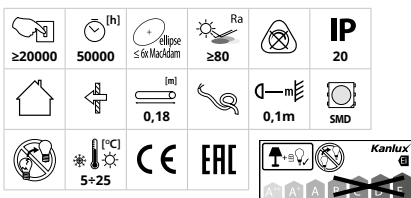

SABIK LED; SABIK LED AC

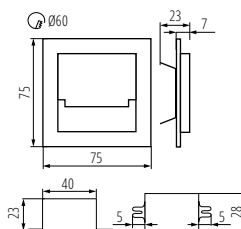

SABIK MINI LED

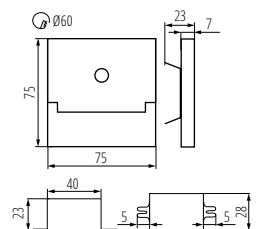

SABIK LED PIR

Kanlux SOLA

OPRAWA PRZYSCHODOWA LED ► STAIRCASE LED LIGHT FITTING



SOLA LED; SOLA LED AC



Kanlux SOLA to nowoczesny design połączony z atrakcyjnym efektem świecenia. To doskonały pomysł na podświetlenie schodów i korytarzy lub na zaakcentowanie wystroju pomieszczeń. Unikatowa konstrukcja oprawy zapewnia równomierną emisję światła. Wersja AC wyposażona jest w zasilacz 230V, który mieści się w puszcze.

Oprawa przystosowana do montażu w puszkach elektroinstalacyjnych Ø 60.
Materiał obudowy: stal nierdzewna szlifowana, tworzywo sztuczne

Kanlux SOLA means modern design combined with an attractive effect of lighting. It is a perfect idea to highlight stairs and corridors or to emphasize decor of rooms. The unique structure of the holders ensures even emission of light. The AC version is equipped with 230V power supply unit which fits into a box.

The fitting is suitable for mounting in Ø 60 junction boxes.
Enclosure material: polished stainless steel, plastic



SOLA LED WW	23100	5905339231000	12 DC	0,8	stal szrotkowana	brushed steel	13	3000
SOLA LED CW	23101	5905339231017	12 DC	0,8	stal szrotkowana	brushed steel	15	6500
SOLA LED AC-WW	23804	5905339238047	220-240 AC	1,3	stal szrotkowana	brushed steel	13	3000
SOLA LED AC-CW	23805	5905339238054	220-240 AC	1,3	stal szrotkowana	brushed steel	15	6500

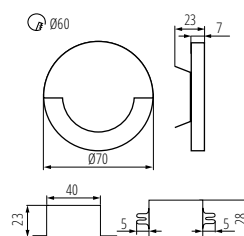

SOLA LED; SOLA LED AC

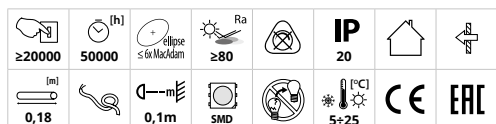

Kanlux LIRIA

OPRAWA PRZYSCHODOWA LED ► STAIRCASE LED LIGHT FITTING



LIRIA LED CW



Kanlux LIRIA LED to nowoczesny design połączony z atrakcyjnym efektem świecenia. To doskonały pomysł na podświetlenie schodów i korytarzy lub na zaakcentowanie wystroju pomieszczeń. Unikatowa konstrukcja oprawy zapewnia równomierną emisję światła. Oprawa do prawidłowego działania wymaga zasilacza, np. DRIFT LED 0-6W.

Oprawa przystosowana do montażu w puszkach elektroinstalacyjnych Ø 60.
Materiał obudowy: stal nierdzewna szlifowana, tworzywo sztuczne

Kanlux LIRIA LED means modern design combined with an attractive effect of lighting. It is a perfect idea to highlight stairs and corridors or to emphasize decor of rooms. The unique structure of the holders ensures even emission of light. To be able to work properly, the holder requires a power supply unit e.g. DRIFT LED 0-6W.

The fitting is suitable for mounting in Ø 60 junction boxes.
Enclosure material: polished stainless steel, plastic



LIRIA LED WW	23114	5905339231147	12 DC	0,8	stal szrotkowana	brushed steel	13	3000
LIRIA LED CW	23115	5905339231154	12 DC	0,8	stal szrotkowana	brushed steel	15	6500
LIRIA LED W-WWW	26844	5905339268440	12 DC	0,8	biały white		13	3000

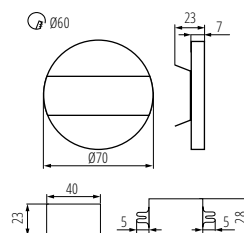

LIRIA LED; LIRIA LED W

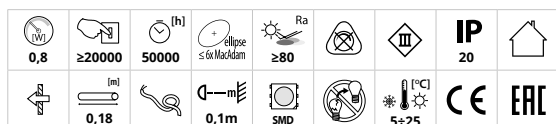

Kanlux LINAR

OPRAWA PRZYSCHODOWA LED ► STAIRCASE LED LIGHT FITTING



LIRIA LED CW

Kanlux LINAR LED to nowoczesny design połączony z atrakcyjnym efektem świecenia. To doskonały pomysł na podświetlenie schodów i korytarzy lub na zaakcentowanie wystroju pomieszczeń. Unikatowa konstrukcja oprawy zapewnia równomierną emisję światła. Oprawa do prawidłowego działania wymaga zasilacza, np. DRIFT LED 0-6W.

Oprawa przystosowana do montażu w puszkach elektroinstalacyjnych Ø 60.

Materiał obudowy: stal nierdzewna szlifowana, tworzywo sztuczne

Kanlux LINAR LED means modern design combined with an attractive effect of lighting. It is a perfect idea to highlight stairs and corridors or to emphasize decor of rooms. The unique structure of the holders ensures even emission of light. To be able to work properly, the holder requires a power supply unit e.g. DRIFT LED 0-6W.

The fitting is suitable for mounting in Ø 60 junction boxes.

Enclosure material: polished stainless steel, plastic



LINAR LED WW	23112	5905339231123	12 DC	0,8	stal szorstkowana brushed steel	13	3000
LINAR LED CW	23113	5905339231130	12 DC	0,8	stal szorstkowana brushed steel	15	6500

0,8	≥20000	50000	50°	Ra ≥80			IP 20	
0,18	0,1 m		5+25					

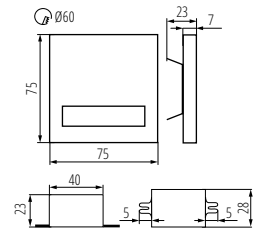

LINAR LED



Kanlux SALUT

OPRAWA NADSZAFKOWA ► OVER-CABINET LIGHT FITTING



SALUT DL-307-S-C/M



SALUT DL-307-S-C/M | **00948** | 5905339009487 max 50 chrom mat | chrome matte

[VI] 12 AC; 12 DC	Gx5,3	IP 20	5+25	CE	ERC
90°	60°	0,5m	MR-16	0.1	

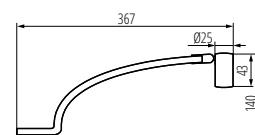

SALUT DL-307-S-C/M

Kanlux PLATEN

OPRAWA NADSZAFKOWA LED IP44 ► OVER-CABINET LED LIGHT FITTING, IP44



PLATEN LED CW



PLATEN LED CW | **23661** | 5905339236616 7 chrom | chrome 530 6500

[VI] 12 DC	≥10000	20000	Ra ≥80	SMD	IP 44
5+25	0,2m	100°	1,5		



Kanlux PLATEN LED to oprawa meblowa, charakteryzuje ją prostokątna forma, zamontowaną na wysięgniku. Wspaniale zestawia się w nowoczesnych przestrzeniach, a jej podwyższony stopień szczelności IP44 pozwala na zastosowanie jej również w kuchni czy łazience. Oprawa do prawidłowego działania wymaga zasilacza, np. DRIFT LED 0-30W.

Materiał obudowy: stal

Kanlux PLATEN LED is a furniture fitting characterized by a rectangular form, mounted on an extension arm. It perfectly matches modern spaces and its increased degree of tightness IP44 allows using it in a kitchen or bathroom as well. To be able to work properly, the holder requires a power supply unit e.g. DRIFT LED 0-30W.

Enclosure material: steel

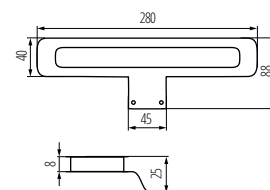

PLATEN LED CW

Kanlux

MERA LED

OPRAWA PODSZAFKOWA LED ► LED UNDER CABINET FITTING

NEW

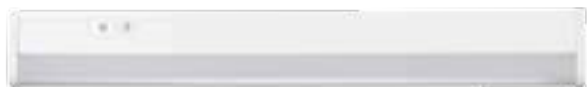

MERA LED 5W NW

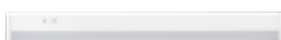

MERA LED 10W NW



MERA LED 15W NW



MERA LED 20W NW



Kanlux MERA LED to oprawa podszafkowa ze zintegrowanym źródłem światła LED. Oprawy są dostępne w rozmiarach od 28 do 114 cm, ponadto możemy je łączyć w linie (do 5 opraw) z pomocą łączników Kanlux MERA LED PP.

Materiał obudowy: tworzywo sztuczne

Materiał klosza: tworzywo sztuczne

Kanlux MERA LED is an under-cupboard luminaire with an integrated LED light source. The luminaires are available in sizes ranging from 28 to 114 cm. Moreover, we can connect them in lines (up to 5 luminaires) using Kanlux MERA LED PP connectors.

Enclosure material: plastic

Lampshade material: plastic



MERA LED 5W NW	29210	5905339292100	5	biały white	490	4000
MERA LED 10W NW	29211	5905339292117	10	biały white	1040	4000
MERA LED 15W NW	29212	5905339292124	15	biały white	1600	4000
MERA LED 20W NW	29213	5905339292131	20	biały white	2030	4000

[V]	[Hz]	[W]	[°]	[h]	[lm]	[K]	[Ra]	[SMD]	[EAC]	[IP]
220-240 AC	50/60	5	150	≥15000	30000	≤60 MacAdam	≥80	SMD	EAC	IP 20
					0,3m	1,5	5+25			

AKCESORIA ► ACCESSORIES

MERA LED PP | **29214** | 5905339292148 | Przewód do łączenia oprawy MERA LED PP / Luminaire connecting cable MERA LED PP

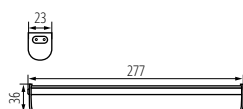

MERA LED 5W NW



MERA LED 10W NW



MERA LED 15W NW

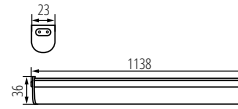

MERA LED 20W NW

Kanlux MERA

OPRAWA PODSZAFKOWA ► UNDER-CABINET LIGHT FITTING



MERA TL-8/2700K; 4000K



MERA TL-13/2700K; 4000K



MERA TL-21/2700K; 4000K



MERA TL-8/4000K	04730	5905339047304	8	biały white
MERA TL-13/4000K	04731	5905339047311	13	biały white
MERA TL-21/4000K	04732	5905339047328	21	biały white
MERA TL-8/2700K	08301	5905339083012	8	biały white
MERA TL-13/2700K	08302	5905339083029	13	biały white
MERA TL-21/2700K	08303	5905339083036	21	biały white



Kanlux MERA to popularna oprawa podszafkowa, którą możemy łączyć w linie. Oprawa doświetli nam blaty w kuchni i wszystkie miejsca gdzie nie dociera górne światło.

Możliwość zasilania przelotowego, przy pomocy przewodu łączeniowego MERA PP do 18 opraw MERA TL-8, do 11 opraw MERA TL-13, do 8 opraw MERA TL-21, do 6 opraw MERA TL-28 albo do 4 opraw MERA TL-35

Matowana, pryzmatyczna osłona źródła światła

Materiał obudowy: tworzywo sztuczne
Materiał klosza: tworzywo sztuczne

Kanlux MERA is a popular under-cabinet fitting which can be combined in lines. The holder will additionally light table tops in a kitchen and all places deprived of upper light.

Optional feed-through power supply using MERA PP connection cable for 18 MERA TL-8 light fixtures, 11 MERA TL-13 light fixtures, 8 MERA TL-21 fixtures, 6 MERA TL-28 fixtures or 4 MERA TL-35 fixtures

Matte, prismatic light source shield

Enclosure material: plastic

Lampshade material: plastic

[V] 220-240 AC	[Hz] 50/60							IP 20	
				0,3m	1.75	5+25	CE	ERC	

AKCESORIA ► ACCESSORIES

MERA PP | **04733** | 5905339047335 | Przewód do łączenia oprawy MERA PP / Luminaire connecting cable MERA PP

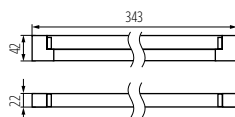

MERA TL-8/2700K; 4000K

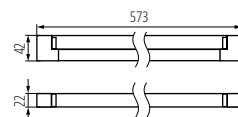

MERA TL-13/2700K; 4000K

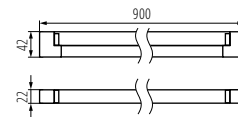

MERA TL-21/2700K; 4000K

LINUS LED

OPRAWA PODSZAFKOWA LED ► LED UNDER CABINET FITTING



LINUS LED 4W-NW



LINUS LED 4W-NW	27590	5905339275905	4	biały white	330	4000
LINUS LED 7W-NW	27591	5905339275912	7	biały white	630	4000

[V] 220-240 AC	[Hz] 50/60		 ≥15000	 30000	 Ra ≥80				
IP 20		[lm] 1,5		 0,1m	 5+25				

AKCESORIA ► ACCESSORIES

LINUS LINK | **14977** | 5907540960618 | Przewód do łączenia oprawy LINUS LINK / Luminaire connecting cable LINUS LINK



Oprawa podszafkowa Kanlux LINUS LED posiada klasyczny i uniwersalny design. Dzięki swym kompaktowym rozmiarom lampa idealnie sprawdzi się do podświetlania różnego rodzaju mebli, szafek jak i półek. Kanlux LINUS LED można łączyć przelotowo przy pomocy przewodu LINUS LINK.

Materiał obudowy: tworzywo sztuczne

Materiał klosza: tworzywo sztuczne

Kanlux LINUS LED under-cabinet holder has classic and universal design. Thanks to its compact dimensions, the lamp will ideally highlight different types of furniture, cabinets and shelves. Kanlux LINUS LED can be combined on a pass-through basis by means of LINUS LINK cable.

Enclosure material: plastic

Lampshade material: plastic

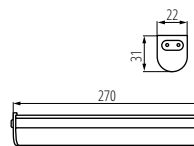

LINUS LED 4W

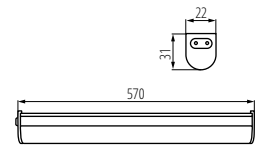

LINUS LED 7W

GLORIA

OPRAWA PODSZAFKOWA ► UNDER-CABINET LIGHT FITTING



Kanlux GLORIA to oprawa podszafkowa. W komplecie wraz oprawą dostajemy świetlówkę T8 o neutralnej barwie światła.

Materiał obudowy: tworzywo sztuczne

Materiał klosza: tworzywo sztuczne

Kanlux GLORIA is an under-cabinet holder. The set, together with the holder, includes a T8 fluorescent lamp with a neutral colour of light.

Enclosure material: plastic

Lampshade material: plastic



GLORIA TL3011-18W



GLORIA TL3011-18W	00510	5905339005106	18	biały white
GLORIA TL3011-30W	00511	5905339005113	30	biały white

[V] 220-240 AC	[Hz] 50/60			 4000				 IP 20	
			 1+2,5	 0,3m	 5+25				

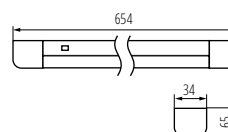

GLORIA TL3011-18W

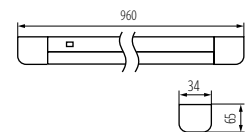

GLORIA TL3011-30W

Kanlux PAX LED

OPRAWA PODSZAFKOWA LED ► LED UNDER CABINET FITTING



PAX TL-90LED



PAX TL-90LED	22190	5905339221902	5,5	srebrny silver	480	4000-4500
PAX TL-60LED	22191	5905339221919	4	srebrny silver	330	4000-4500

[V] 220-240 AC	[Hz] 50/60			 Ra ≥80	 SMD	 IP 20	
	 130	 ≥10000	 1+2,5	 0,2m	 5+25		

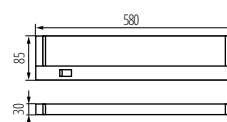

PAX TL-90LED

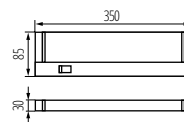

PAX TL-60LED

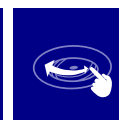

Kanlux PAX LED to podszafkowe oprawy liniowe ze zintegrowanym źródłem światła. Dużym udogodnieniem jest możliwość skierowania strumienia światła w górę lub w dół.

Materiał obudowy: tworzywo sztuczne
Materiał klosza: tworzywo sztuczne

Kanlux PAX LED are under-cabinet linear holders with an integrated source of light. A possibility of directing the light stream upwards or downwards is a large convenience.

Enclosure material: plastic
Lampshade material: plastic

Kanlux ZEPO

OPRAWA PODSZAFKOWA PUNKTOWA ► UNDER-CABINET SPOTLIGHT FITTING



ZEPO LFD-T02-C/M



ZEPO LFD-T02-C/M	04381	5905339043818	max 20	chrom mat chrome matte
ZEPO LFD-T02/S-C/M	04386	5905339043863	max 20	chrom mat chrome matte

[V] 12 AC; 12 DC		 IP 20			
	 0,3m	 0.1	 5+25		

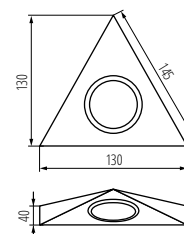

ZEPO LFD-T02

Seria oczek Kanlux ZEPO to oświetlenie przeznaczone pod szafki m.in. nad kuchennym blatem. ZEPO dostępne są w wersji z wyłącznikiem jak i bez. Do opraw wymagany jest zasilacz np. z serii SET. Źródło światła przeznaczone do oczek to JC z gwintem G4.

Oprawa ZEPO LFD-T02/S-C, ZEPO LFD-T02/S-C/M, ZEPO LFD-T02/S-BR/M wyposażona we włącznik
Materiał obudowy: stal
Materiał klosza: szkło

The Kanlux ZEPO series of eyes is the lighting intended under cabinets, for example, above a table top in a kitchen. ZEPOs are available in a version with an OFF switch and without it. The holders require a power supply unit e.g. from the SET series. JC thread is a light source intended for the eyes.

ZEPO LFD-T02/S-C, ZEPO LFD-T02/S-C/M, ZEPO LFD-T02/S-BR/M light fixtures provided with a power switch

Enclosure material: steel
Lampshade material: glass

Kanlux GAVI

OPRAWA MEBLOWA PUNKTOWA ► SPOTLIGHT FITTING FOR FURNITURE UNITS



GAVI CT-2116B-W



GAVI CT-2116B-C



GAVI CT-2116B-BR/M



GAVI CT-2116B-C/M

Kanlux GAVI to oprawy meblowe wykonane ze szkła i stali. Bezpretensjonalna kolorystyka pozwala im dyskretnie wpasować się w miejsce montażu.

Materiał obudowy: stal

Kanlux GAVI are furniture fittings made of glass and steel. Unpretentious colour scheme allows them to discretely fit into the place of assembly.

Enclosure material: steel



GAVI CT-2116B-W	00810	5905339008107	max 20	biały white
GAVI CT-2116B-C	00811	5905339008114	max 20	chrom chrome
GAVI CT-2116B-BR/M	00814	5905339008145	max 20	mosiądz matowy matt brass
GAVI CT-2116B-C/M	00815	5905339008152	max 20	chrom mat chrome matte

				IP 20		
				CE	ERC	
A A A B C D E						

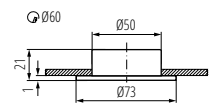

GAVI CT-2116B

Kanlux GAVI LED

OPRAWA MEBLOWA PUNKTOWA LED ► LED SPOTLIGHT FITTING FOR FURNITURE UNITS



GAVI LED18 SMD-WW-C/M



GAVI LED18 SMD-WW-C/M | 19761 | 5905339197610 | 0,8 | chrom mat | chrome matte | 42 | 2800-3200

[VI]	12 DC	≥15000	30000	Ra ≥80	SMD	IP 20
5+25	0,1m	0,1m	0,60	CE	ERC	Kanlux

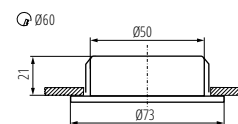

GAVI LED18 SMD

Kanlux PIRMO

OPRAWA MEBLOWA LED ► LED LIGHT FITTING FOR FURNITURE UNITS



PIRMO LED SMD NW-GR



PIRMO LED SMD NW-GR | 23710 | 5905339237101 | 1 | szary | grey | 65 | 4000

[VI]	12 DC	≥15000	30000	Tc (K) 4000	Ra ≥80	SMD	IP 20
5+25	0,1m	0,1m	110	1,5	CE	ERC	Kanlux



Kanlux PIRMO LED to nowoczesna oprawa meblowa, wyposażona w czujnik zbliżeniowy. Przeznaczona jest do oświetlenia szaf, barków czy większych komód. Wykonana z tworzywa sztucznego w kolorze aluminium, dostępna jest w neutralnej barwie światła. Zaletą oprawy jest szybki i łatwy montaż za pomocą dwóch wkrętów. Do prawidłowego działania oprawy, potrzebny jest zasilacz.

Materiał obudowy: tworzywo sztuczne
Materiał klosza: tworzywo sztuczne

Kanlux PIRMO LED is a modern furniture fitting, equipped with a proximity detector. It is intended for lighting cabinets, drinks cabinets or larger chests of drawers. It is made of plastic in aluminium colour and available in a neutral colour of light. Quick and easy assembly by means of two screws is an advantage of the holder. To be able to work properly, the holder requires a power supply unit.

Enclosure material: plastic
Lampshade material: plastic

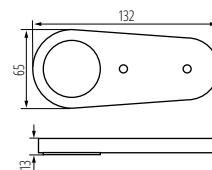

PIRMO LED SMD

RUBINAS

OPRAWA MEBLOWA AKCENTOWA LED ► LED MIRROR LIGHT FITTING FOR FURNITURE UNITS



RUBINAS 2LED WW



RUBINAS 2LED WW	23790	5905339237903	1	szary grey	40	3000
RUBINAS 2LED CW	23791	5905339237910	1	szary grey	40	6500
RUBINAS 3LED WW	23792	5905339237927	1,5	szary grey	50	3000
RUBINAS 3LED CW	23793	5905339237934	1,5	szary grey	50	6500

[V] 12 DC	≥15000	[h] 30000	ellipse ≤60 MacAdam	Ra ≥80	SMD	III
IP 20	5+25	[m] 1,5	CE	ERAC	Kanlux	



Kanlux RUBINAS to dekoracyjna meblowa oprawa LED. Oprawa montowana jest na półce. Przy szklanych półkach możemy skorzystać z wersji, która oprócz świecenia w górę i w dół rozświetli nam również samą półkę tworząc unikatowy efekt dekoracyjny.

Materiał obudowy: stop aluminium

Kanlux RUBINAS is a decorative furniture LED fitting. The holder is mounted on a shelf. With regard to glass shelves, you can use the version which, apart from lighting upwards and downwards, will light up the shelf itself too, creating a unique decorative effect.

Enclosure material: aluminum alloy

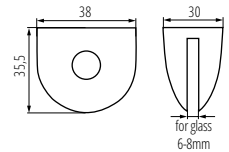

RUBINAS 2LED

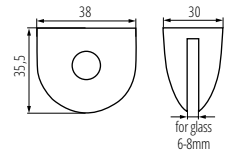

RUBINAS 3LED

ZAFIRAS

OPRAWA MEBLOWA AKCENTOWA LED ► LED MIRROR LIGHT FITTING FOR FURNITURE UNITS



ZAFIRAS LED WW



ZAFIRAS LED WW	23700	5905339237002	1,5	szary grey	30	3000
ZAFIRAS LED CW	23701	5905339237019	1,5	szary grey	30	6500

[V] 12 DC	≥15000	[h] 30000	ellipse ≤60 MacAdam	Ra ≥80	SMD	III
IP 20	5+25	[m] 1,5	CE	ERAC	Kanlux	



Kanlux ZAFIRAS to dekoracyjna meblowa oprawa LED. Oprawę montujemy na półce uzyskując przy tym świecenie w dwóch kierunkach - góra i dół.

Materiał obudowy: metal, PC

Kanlux ZAFIRAS is a decorative furniture LED fitting. The holder is mounted on a shelf with an effect of lighting in two directions - upwards and downwards.

Enclosure material: Metal, PC

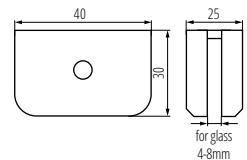

ZAFIRAS LED

Kanlux

DB

ROZDZIELACZ ► DISTRIBUTOR

Materiał obudowy: tworzywo sztuczne

Enclosure material: plastic



DB-FF6 12/24VDC

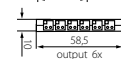
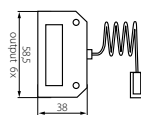

DB-FF6 12/24VDC

DB-FF6 12/24VDC | **23572** | 5905339235725 | max 36W(12V)/72W (24V) | biały | white

			IP			
12 DC; 24 DC	max 36W(12V)/72W (24V)		20	3		

Kanlux

DRIFT

ZASILACZ LED ► LED POWER SUPPLY UNIT



DRIFT LED F 0-18W

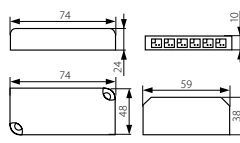

DRIFT LED F 0-18W

DRIFT LED F 0-18W | **18042** | 5905339180421 | max 18 | biały | white

					IP			
220-240 AC	50/60	max 18	220-240	12V DC	20			



Kanlux

FOLLO LED

LAMPKA BIURKOWA LED ► LED DESK LAMP

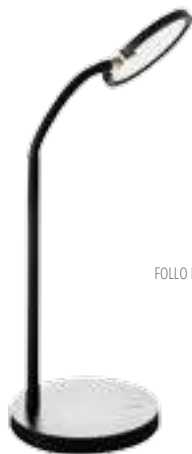

FOLLO LED B



FOLLO LED W	28790	5905339287908	6	biały white	max 340	3000
FOLLO LED B	28791	5905339287915	6	czarny black	max 340	3000

[V]	[Hz]		\angle [°]						
220-240 AC	50/60		95	≥ 12000	20000	≥ 80	SMD	IP 20	0,1m
		\angle [°]	\angle [°]	[m]					
		360	360	1,8					



Kanlux FOLLO LED to nie tylko lampka biurkowa, ale również designerska ozdoba, każdego wnętrza. Lampka posiada specjalne podświetlenie krawędziowe i mleczny klosz, dzięki temu światło ma przyjemny ciepły odcień. Elegancja, minimalizm, gitkie ramie i 3 poziomy ściemniania to dodatkowe atuty lampki Kanlux FOLLO.

Materiał obudowy: tworzywo sztuczne
Materiał klosza: tworzywo sztuczne

The Kanlux FOLLO LED is not only a desk lamp, but also a design decoration for any interior. This lamp has a special edge illumination and a milky lampshade, thanks to which the light has a pleasant warm shade. The additional advantages of The Kanlux FOLLO lamp are its elegance, minimalism, flexible arm, and 3 levels of dimming.

Enclosure material: plastic
Lampshade material: plastic

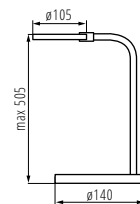

FOLLO LED

Kanlux

FRANCO

LAMPKA BIURKOWA LED ► LED DESK LAMP



FRANCO 15LED SMD KT-W



FRANCO 15LED SMD KT-W	22340	5905339223401	max 6,5	biały white	max 390	2700-3200
FRANCO 15LED SMD KT-B	22341	5905339223418	max 6,5	czarny black	max 390	2700-3200

[V]	[Hz]		\angle [°]						
220-240 AC	50/60		100	≥ 10000	20000	≥ 80	SMD	IP 20	0,1m
		\angle [°]	\angle [°]	[m]					
		360	360	1,8					



Kanlux FRANCO to opływowa w kształcie, dyskretna, a zarazem elegancka lampka stojąca. Świetna jako oświetlenie biurkowe, ale również jako dodatkowe oświetlenie pomieszczenia czy lampka nocna. Wygodnym rozwiązaniem jest możliwość regulacji natężenia światła, dzięki której możemy dopasować jasność oświetlenia do własnych potrzeb i pory dnia.

wyposażona w sensor umieszczony w podstawie, dzięki któremu poprzez dotyk można włączyć/wyłączyć lampkę lub ustawić intensywność świecenia (3 stopnie jasności)

Materiał obudowy: tworzywo sztuczne
Materiał klosza: tworzywo sztuczne

Kanlux FRANCO is a streamlined, in terms of shape, discrete and at the same time elegant standing lamp. It works perfectly as the desk lighting and also as the additional lighting of a room or a bedside lamp. A possibility of adjusting the intensity of light is a convenient solution, thanks to which you can adapt brightness of light to own needs and time of day.

the base plate is provided with a sensor that enables switching on/off the lamp or controlling the light intensity by touch (3 brightness levels)

Enclosure material: plastic
Lampshade material: plastic

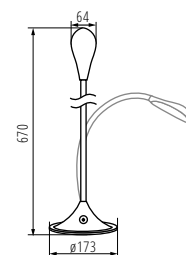

FRANCO 15LED SMD

Kanlux DOSAN

LAMPKA BIURKOWA LED ► LED DESK LAMP



DOSAN LED W

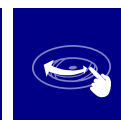

Kanlux DOSAN LED to lampa biurkowa o minimalistycznym designie. Dzięki swojej linii stylistycznej będzie pasowała do praktycznie każdego wnętrza. Dodatkową zaletą lampy jest możliwość zmiany natężenia światła (3 poziomy). Dzięki pełnej regulacji ramienia lampa nie zajmuje dużo miejsca i pozwala nam skierować światło w dowolne miejsce.

Materiał obudowy: tworzywo sztuczne

Materiał klosza: tworzywo sztuczne

Kanlux DOSAN LED is a desk lamp with minimalist design. Thanks to its stylistic line, it will match each interior in practice. A possibility of changing the intensity of light (3 levels) is an additional advantage of the lamp. Thanks to full adjustment of the arm, the lamp does not need a lot of space and allows you to direct light into any place.

Enclosure material: plastic

Lampshade material: plastic



DOSAN LED W	26690	5905339266903	max 9	biały white	max 350	4000
DOSAN LED B	26691	5905339266910	max 9	czarny black	max 350	4000

[V]	[Hz]		[°]					
220-240 AC	50/60		120	≥15000	≤60 MacZkam	SMD	IP 20	0,1m
		170	1,4					

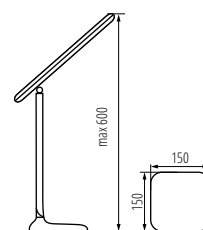

DOSAN LED

Kanlux ISTI LED

LAMPKA BIURKOWA LED ► LED DESK LAMP



ISTI LED W



Kanlux ISTI LED to nowoczesna lampa, wyposażona w dotykowy wyłącznik z 4-poziomą funkcją ściemniania, regulację temperatury barwowej i dodatkowe światło nocne (1W / 30lm).

Materiał obudowy: tworzywo sztuczne

Materiał klosza: tworzywo sztuczne

The Kanlux ISTI LED is a modern lamp, equipped with a touch switch with 4-level dimming function, colour-temperature control, and additional night light (1W / 30lm).

Enclosure material: plastic

Lampshade material: plastic

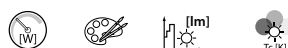

ISTI LED W	27360	5905339273604	max 10	biały white	max 500	2700/4500/6000
ISTI LED B	27361	5905339273611	max 10	czarny black	max 500	2700/4500/6000

[V]	[Hz]		[°]		[h]				
220-240 AC	50/60		110	≥15000	20000	≤60 MacZkam	≥80	SMD	IP 20
		180	1,5						

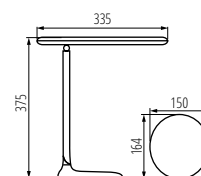

ISTI LED



SARI LED B-CH



SARI LED B-SR



SARI LED W-SR



Kanlux SARI to LEDowa lampka biurkowa, nocna, stołowa - sami wybierzcie dla niej odpowiednie zastosowanie, pewne jest to, że jej design urzeka. Ponadczasowa elegancja to jej atut. Kanlux SARI ma wbudowane źródło LED o mocy 4,5W idealna sprawdza się przy odrabianiu lekcji, w kąciaku do czytania, a także jako lampka nocna. Swobodna regulacja kierunku świecenia i bardzo dobra jakość wykonania to kolejne zalety tej lampki.

Materiał obudowy: tworzywo sztuczne
Materiał klosza: tworzywo sztuczne

Kanlux SARI is a LED desk, bedside, table lamp - please choose its intended use for it on your own. It is undisputable that its design captivates. The supratemporal elegance is its asset. Kanlux SARI has an embedded LED source with power of 4.5W, ideal while doing homework, in a reading niche and also as a bedside lamp. The free adjustment of the light direction and very good quality of finishing touch are further advantages of this lamp.

Enclosure material: plastic
Lampshade material: plastic



SARI LED B-CH	27980	5905339279804	4,5	czarny / szampański black / champagne	270	3000
SARI LED B-SR	27981	5905339279811	4,5	czarny / srebrny black / silver	270	3000
SARI LED W-SR	27982	5905339279828	4,5	biały / srebrny white / silver	270	3000

[V] 220-240 AC	[Hz] 50/60		 95	 ≥15000	 20000	 Ra ≥80
		 IP 20	 0,1m			
 180	 180	 1,5				

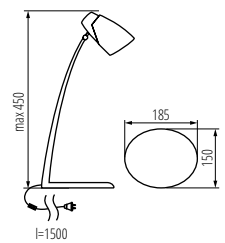

SARI LED

Kanlux

PIXA

LAMPKA BIURKOWA ► DESK LAMP



PIXA KT-40-W



PIXA KT-40-B



Kanlux PIXA to kultowa lampka biurkowa na wymienne źródło światła. Jej budowa pozwala skierować strumień świetlny w dowolnym kierunku przy czym klosz lampki ogranicza jego padanie na boki. Lampka ta doskonale wpisze się w każdy rodzaj wnętrza - od pokoju dziecięcego po biurko w gabinecie prezesa.

Materiał obudowy: tworzywo sztuczne, metal

Materiał klosza: metal

Kanlux PIXA is a cult desk lamp with a replaceable light source. Its structure allows directing the light stream into any direction with the reservation that the lampshade of the lamp reduces its falling aside. This lamp will perfectly fit into each type of interiors - from a child's room to a desk in an office of a president.

Enclosure material: plastic, Metal

Lampshade material: Metal



PIXA KT-40-W	19300	5905339193001	max 40	biały white
PIXA KT-40-B	19301	5905339193018	max 40	czarny black

[V]	[Hz]			IP			
220-240 AC	50/60			20	0,1m		E14
	360	180	1,6				

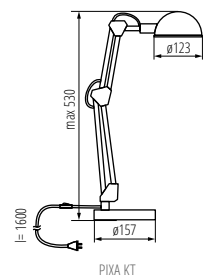

PIXA KT

Kanlux SUZI

LAMPKA BIURKOWA ► DESK LAMP



SUZI HR-60-SR



SUZI HR-60-B



SUZI HR-60-BL



SUZI HR-60-PK



Kanlux SUZI to prosta lampka biurkowa. Dostępna jest kilku jednolitych wersjach kolorystycznych. Kanlux SUZI posiada regulowane ramię i klips dzięki któremu możemy umocować lampkę na krawędzi biurka lub na półce.

wysięgnik giętki
montaż za pomocą klipsa
Materiał obudowy: tworzywo sztuczne
Materiał klosza: stal

Kanlux SUZI is a simple desk lamp. It is available in several uniform colour versions. Kanlux SUZI has an adjustable arm and a clip thanks to which you can fix the lamp on a desk edge or on a shelf.

flexible exterior arm
clip-on installation
Enclosure material: plastic
Lampshade material: steel



SUZI HR-60-SR	07150	5905339071507	max 40	srebrny silver
SUZI HR-60-B	07151	5905339071514	max 40	czarny black
SUZI HR-60-BL	07152	5905339071521	max 40	niebieski blue
SUZI HR-60-PK	07153	5905339071538	max 40	różowy pink

[V] 220-240 AC	[Hz] 50/60			IP 20	 0,2m				
	 360	 360	 1,5						

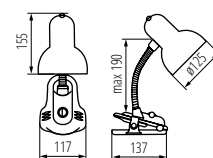

SUZI HR-60



ZARA HR-40-B



ZARA HR-40-SR



ZARA HR-40-BL



ZARA HR-40-OR



Seria lampek biurkowych Kanlux ZARA to żywe i ciekawe kolory, które idealnie ożywią każde biurko. Do lampek biurkowych Kanlux ZARA pasują źródła światła z trzonkiem E14 o maksymalnej mocy 40W.

Materiał obudowy: stal

Materiał klosza: stal

The series of the Kanlux ZARA desk lamps means vivid and interesting colours which will ideally revive each desk. Light sources with E14 light bulb base with maximum power of 40W match the Kanlux ZARA desk lamps.

Enclosure material: steel

Lampshade material: steel



ZARA HR-40-SR	07560	5905339075604	max 40	srebrny silver
ZARA HR-40-B	07561	5905339075611	max 40	czarny black
ZARA HR-40-BL	07562	5905339075628	max 40	niebieski blue
ZARA HR-40-OR	07563	5905339075635	max 40	pomarańczowy orange

[V]	[Hz]			IP					 Kanlux
220-240 AC	50/60	E14	20	0,2m				A+ A A B C D E	
360	360	1,5							

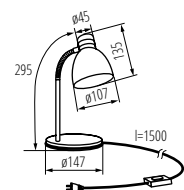

ZARA HR-40

Kanlux CYDEA

LAMPA STOŁOWA ► TABLE LAMP



CYDEA D



CYDEA D | 25551 | 5905339255518 | max 40 | biały | white



Kanlux CYDEA to oprawy, które możesz zastosować jako oświetlenie główne, a także jako uzupełniające, gdyż na tę rodzinę składa się: oprawa wisząca, podłogowa oraz stołowa. Dużym atutem tych opraw jest materiał z jakiego został wykonany klosz, jest to folia polipropylenowa, która podlega recyklingowi, a przede wszystkim jest niezwykle łatwa w utrzymaniu czystości.

Materiał obudowy: metal
Materiał klosza: folia polipropylenowa

Kanlux CYDEA are holders which can be used as main or additional lighting because this family comprises: a hanging holder, floor holder and table holder. The material of which the lampshade was made i.e. polypropylene foil which is subject to recycling and, mainly, can extremely easily be cleaned is a big asset of these holders.

Enclosure material: Metal
Lampshade material: Polypropylene film

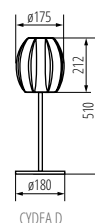

CYDEA D

Kanlux CYDEA

LAMPA PODŁOGOWA ► FLOOR LAMP



CYDEA F



CYDEA F | 25550 | 5905339255501 | max 60 | biały | white



Kanlux CYDEA to oprawy, które można zastosować jako oświetlenie główne, a także jako uzupełniające, gdyż na tę rodzinę składa się: oprawa wisząca, podłogowa oraz stołowa. Dużym atutem tych opraw jest materiał z jakiego został wykonany klosz, jest to folia polipropylenowa, która podlega recyklingowi, a przede wszystkim jest niezwykle łatwa w utrzymaniu czystości.

Materiał obudowy: metal
Materiał klosza: folia polipropylenowa

Kanlux CYDEA are holders which can be used as main or additional lighting because this family comprises: a hanging holder, floor holder and table holder. The material of which the lampshade was made i.e. polypropylene foil which is subject to recycling and, mainly, can extremely easily be cleaned is a big asset of these holders.

Enclosure material: Metal
Lampshade material: Polypropylene film

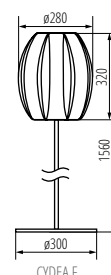

CYDEA F

Kanlux



OPRAWY TECHNICZNE I ARCHITEKTONICZNE
TECHNICAL AND ARCHITECTURAL FIXTURES

**Rozświetlamy już tysiące mieszkań,
setki biur i inwestycji.**

**Rozwijamy się dotrzymując kroku
pędzącej technologii, ale również
słuchając Twoich potrzeb.**

We are already lighting up thousands of flats,
and hundreds of offices and investment buildings.
We are developing at the same rate as all
the develop keeping pace with fast
evolving technology, all the while listening
to your needs.



*dane fotometryczne znajdziesz na:
photometric data you can find on:*

► kanlux.com

BRAVO P / PU

PANEL LED PODTYNKOWY ► RECESSED LED PANEL



BRAVO P 36W6060NW W



BRAVO PU36W12030NW W



BRAVO P 36W6060NW SR



BRAVO P 36W6060NW SR



BRAVO PU36W6060NW W



BRAVO PU28W3060NW W

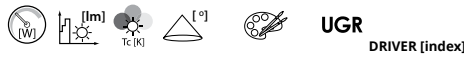

BRAVO P 36W6060NW W	28000	5905339280008	36	4320	4000	110	biały white	DRIVER [index]	28025	
BRAVO P 36W6060NW SR	28001	5905339280015	36	4320	4000	110	srebrny silver	28025		
BRAVO PU36W6060NW W	28002	5905339280022	36	4320	4000	110	biały white	<19	28025	
BRAVO PU36W6060NW SR	28003	5905339280039	36	4320	4000	110	srebrny silver	<19	28025	
BRAVO P 36W6060CW W	28006	5905339280060	36	4320	6500	110	biały white	28025		
BRAVO P 45W6060NW SR	28009	5905339280091	45	5400	4000	110	srebrny silver	28027		
BRAVO P 36W12030NW W	28020	5905339280206	36	4320	4000	110	biały white	28025		
BRAVO P 36W12030NW SR	28021	5905339280213	36	4320	4000	110	srebrny silver	28025		
BRAVO PU36W6262NW W	28024	5905339280244	36	4320	4000	110	biały white	<19	28025	
BRAVO PU36W12030NW W	28550	5905339285508	36	4320	4000	110	biały white	<19	28025	
BRAVO PU28W3060NW W	28551	5905339285515	28	3360	4000	90	biały white	<19	28029	

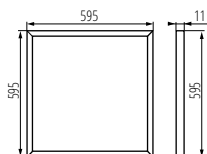
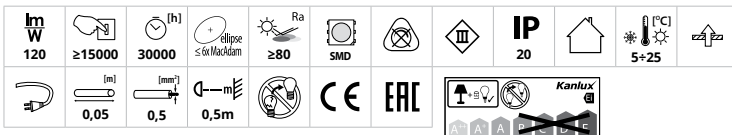

BRAVO P/PU 6060

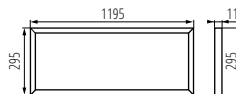

BRAVO P/PU 12030

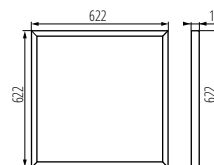

BRAVO PU36W6262



BRAVO PU28W3060

BRAVO P / PU

PANEL LED PODTYNKOWY ► RECESSED LED PANEL



LOW UGR



Panele Kanlux BRAVO P/PU to specjalnie wybrane komponenty dla jeszcze większej satysfakcji z ich użytkowania. Aluminiowa ramka, specjalnie dobrane diody LED, odbłyśnik i dyfuzor rozpraszający światło to tylko niektóre atuty paneli Kanlux BRAVO LED P/PU. Kolejnym atutem tych paneli jest wysoka skuteczność świetlna (120lm/W). Pewni ich jakości udzielamy na nie 5 lat gwarancji. Panele Kanlux BRAVO LED nie posiadają zasilacza w komplecie.

5 lat Gwarancji na warunkach oświadczenia gwarancyjnego, dostępnego na stronie internetowej

Do prawidłowego działania wymagany jest zasilacz elektroniczny dostępny w ofercie KANLUX.

Brak zasilacza w komplecie.

Produkt o kodzie 28024 przeznaczony jest do alternatywno rozmiaru systemów sufitowych (625mmx625mm)

Atest PZH: Numer BK/B/1070/01/2018, ważny do 2023-12-18

Materiał obudowy: stop aluminium

Materiał klosza: tworzywo sztuczne

Materiał panelu/ramki: stop aluminium

Kanlux BRAVO P/PU panels are components specially selected to ensure greater satisfaction with their use. The aluminium frame, specially selected LED's, reflector, and light diffuser, are just a few of the advantages of Kanlux BRAVO LED P/PU panels. The high light efficiency (120lm/W) is yet another advantage of these panels. Being sure of their quality, we give a 5-year warranty on them. Kanlux BRAVO LED panels do not include a power supply.

5 years Warranty under the terms of the warranty statement, available on our website

The correct LED power supply available in the KANLUX range is required for proper operation

LED panel without power supply included

The product with the code 28024 is designed for alternative-size ceiling systems (625mm x 625mm)

Enclosure material: aluminum alloy

Lampshade material: plastic

Panel/frame material: aluminum alloy

ZASILACZE ► DRIVERS

BRAVO DRIVER 28W	28029	
BRAVO DRIVER 36W	28025	
BRAVO DRIVER 45W	28027	
BRAVO DALI SET 36W	28508	
BRAVO DALI SET 45W	28507	

[V] 220-240V~	[Hz] 50/60	8 cm		
[mA] 0,75 - 1,5				IP 20



BRAVO DRIVER



BRAVO S/P GRIP



CLIPS BRAVO S/P



SPN BRAVO S/P



ADTR



PSR 100

	index	BRAVO S/P GRIP		CLIPS BRAVO S/P		SPN BRAVO S/P		ADTR			PSR 100		
		60x60 / 62x62	120x30	60x60 / 62x62	120x30	60x60 / 62x62	120x30	60x60 (SR)	60x60 (W)	60x60 (B)	120x30 (SR)	120x30 (W)	60x60 / 62x62
		28500	28501	28502	28503	28504	28505	27610	27613	27615	27612	27611	25591
BRAVO P 36W6060NW W	28000	✓		✓		✓		✓	✓	✓			✓
BRAVO P 36W6060NW SR	28001	✓		✓		✓		✓	✓	✓			✓
BRAVO PU36W6060NW W	28002	✓		✓		✓		✓	✓	✓			✓
BRAVO PU36W6060NW SR	28003	✓		✓		✓		✓	✓	✓			✓
BRAVO P 36W6060CW W	28006	✓		✓		✓		✓	✓	✓			✓
BRAVO P 45W6060NW W	28008	✓		✓		✓		✓	✓	✓			✓
BRAVO P 45W6060NW SR	28009	✓		✓		✓		✓	✓	✓			✓
BRAVO PU36W6262NW W	28024	✓		✓		✓							✓
BRAVO P 36W12030NW W	28020		✓		✓		✓				✓	✓	
BRAVO P 36W12030NW SR	28021		✓		✓		✓				✓	✓	
BRAVO PU28W3060NW W	28551	✓		✓		✓							✓

BRAVO S / SU

PANEL LED PODTYNKOWY ► RECESSED LED PANEL



BRAVO SU40W6060NW SR



BRAVO S 40W12030NW W



BRAVO S 40W12030NW SR



BRAVO SU40W6060NW W

**LOW
UGR**



UGR DRIVER [index]

Model	Code	Power [W]	Beam angle [°]	Luminous flux [lm]	Color temperature [K]	Beam spread [°]	Color	UGR	DRIVER [index]
BRAVO S 40W6060NW W	28010	5905339280107	40	4000	4000	110	biały white		28026
BRAVO S 40W6060NW SR	28011	5905339280114	40	4000	4000	110	srebrny silver		28026
BRAVO SU40W6060NW W	28012	5905339280121	40	4000	4000	110	biały white	< 19	28026
BRAVO SU40W6060NW SR	28013	5905339280138	40	4000	4000	110	srebrny silver	< 19	28026
BRAVO S 40W6060CW W	28016	5905339280169	40	4000	6500	110	biały white		28026
BRAVO S 50W6060NW W	28018	5905339280183	50	5000	4000	110	biały white		28028
BRAVO S 50W6060NW SR	28019	5905339280190	50	5000	4000	110	srebrny silver		28028
BRAVO S 40W12030NW W	28022	5905339280220	40	4000	4000	110	biały white		28026
BRAVO S 40W12030NW SR	28023	5905339280237	40	4000	4000	110	srebrny silver		28026

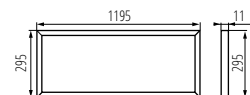
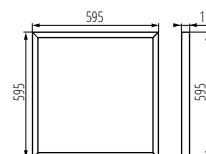

BRAVO S/SU 6060

BRAVO S 12030NW



Panele Kanlux BRAVO S/SU to specjalnie wybrane komponenty dla jeszcze większej satysfakcji z ich użytkowania. Aluminiowa ramka, specjalnie dobrane diody LED, odbłyśnik i dyfuzor rozpraszający światło to tylko niektóre atuty paneli Kanlux BRAVO LED S/SU. Kolejnym atutem tych paneli jest wysoka skuteczność świetlna (100lm/W). Panele Kanlux BRAVO LED nie posiadają zasilacza w komplecie.

Do prawidłowego działania wymagany jest zasilacz elektroniczny dostępny w ofercie KANLUX.
 Atest PZH: Numer BK/B/1070/01/2018, ważny do 2023-12-18
 Brak zasilacza w komplecie.
 Materiał obudowy: stal
 Materiał klosza: tworzywo sztuczne
 Materiał panelu/ramki: stop aluminium

Kanlux BRAVO S/SU panels are specially selected components for even greater satisfaction with their use. Aluminium framework, specially selected LED diodes, reflector and diffuser distracting light are just some of the assets of Kanlux BRAVO LED S/SU panels. High luminous efficacy (100lm/W) is another asset of these panels. Kanlux BRAVO LED panels do not have any power supply included.

The correct LED power supply available in the KANLUX range is required for proper operation
 LED panel without power supply included
 Enclosure material: steel
 Lampshade material: plastic
 Panel/frame material: aluminum alloy

ZASILACZE ► DRIVERS

BRAVO DRIVER 40W	28026	
BRAVO DRIVER 50W	28028	

[W] 220-240V~	[Hz] 50/60	8 cm		
0,75 - 1,5				IP 20



BRAVO DRIVER



BRAVO S/P GRIP



CLIPS BRAVO S/P



SPN BRAVO S/P



ADTR



PSR 100

	index	BRAVO S/P GRIP		CLIPS BRAVO S/P		SPN BRAVO S/P		ADTR			PSR 100		
		60x60 / 62x62	120x30	60x60 / 62x62	120x30	60x60 / 62x62	120x30	60x60 (SR)	60x60 (W)	60x60 (B)	120x30 (SR)	120x30 (W)	60x60 / 62x62
BRAVO S 40W6060NW W	28010	✓		✓		✓		✓	✓	✓			✓
BRAVO S 40W6060NW SR	28011	✓		✓		✓		✓	✓	✓			✓
BRAVO SU40W6060NW W	28012	✓		✓		✓		✓	✓	✓			✓
BRAVO SU40W6060NW SR	28013	✓		✓		✓		✓	✓	✓			✓
BRAVO S 40W6060CW W	28016	✓		✓		✓		✓	✓	✓			✓
BRAVO S 50W6060NW W	28018	✓		✓		✓		✓	✓	✓			✓
BRAVO S 50W6060NW SR	28019	✓		✓		✓		✓	✓	✓			✓
BRAVO S 40W12030NW W	28022		✓		✓		✓				✓	✓	
BRAVO S 40W12030NW SR	28023		✓		✓		✓				✓	✓	

BLINGO LED

PANEL LED PODTYNKOWY ► RECESSED LED PANEL

NEW



BLINGO LED 36W

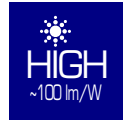

Kanlux BLINGO LED to nowy rodzaj paneli LED. Moduły świecą bezpośrednio w dół, a nie światłem odbitym. Kanlux BLINGO LED to cienkie panele bez widocznych punktów świetlnych. Zastosowane moduły dzięki specjalnym soczewkom poszerzają kąt emisji światła.

Materiał obudowy: stal

Materiał klosza: tworzywo sztuczne

Materiał panelu/ramki: stop aluminium

Kanlux BLINGO LED is a new type of LED panels. The modules light directly downwards and not with reflected light. Kanlux BLINGO LED are thin panels without visible lighting points, thanks to the use of special lenses the modules extend the angle of light.

Enclosure material: steel

Lampshade material: plastic

Panel/frame material: aluminum alloy



BLINGO LED36W 6060 NW



BLINGO LED48W 6060 NW

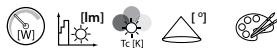

BLINGO LED36W 6060 NW	29820	5905339298201	36	3600	4000	120	biały white
BLINGO LED48W 6060 NW	29821	5905339298218	48	4800	4000	120	biały white

[V] 220-240 AC	[Hz] 50/60	[h] ≥15000	[h] 25000	[Ra] Ra ≥80	[SMD]	[IP]	[Kantlux]
IP 20	[°C] 5+25	[m]	[m]	[m]	[m]	[m]	[m]

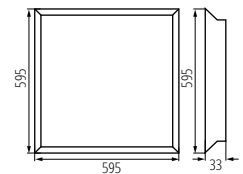

BLINGO LED36W, BLINGO LED48W

Kanlux TOWE LED

PANEL LED NATYNKOWY ► SURFACE-MOUNTED LOUVER FITTING



Kanlux TOWE LED to natynkowa wersja paneli LED. Równomierne rozmieszczenie diod LED wewnątrz oprawy zapewnia jednorodną emisję światła. Szybka instalacja oprawy możliwa jest dzięki czterem otworom umożliwiających montaż przy pomocy standardowych kołków.

Materiał obudowy: stal
Materiał klosza: tworzywo sztuczne

Kanlux TOWE LED is a facade version of LED panels. Even arrangement of LEDs inside the luminaire ensures homogeneous light emission. Four holes for mounting using standard plugs make the installation of the luminaire quick.

Enclosure material: steel
Lampshade material: plastic



TOWE LED 36W-NW



TOWE LED 36W-NW | 25790 | 5905339257901 | 36 | 3200 | 4000 | 110 | biały | white

[V] 220-240 AC	[Hz] 50/60	[lm] ≥15000	[h] 20000	Tc (K) 4000	dipose ≤6x Nachdam	Ra ≥80	SMD	IP 20
House icon	5+25	Mounting icon	Box icon	0,75-2,5	0,5m	CE	ERL	Kanlux logo

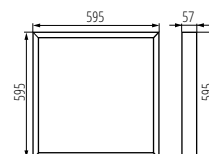

TOWE LED 36W-NW

Kanlux NOTUS 4LED

OPRAWA RASTROWA NATYNKOWA
► SURFACE-MOUNTED LOUVER FITTING

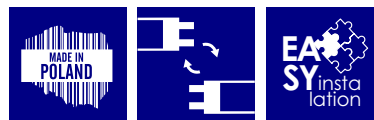

NOTUS 4LED 236 NT

Kanlux NOTUS 4LED to oprawy rastrowe natynkowe, przystosowane do świetlówek ledowych T8. Produkowane są w Polsce, z komponentów od polskich dostawców. Rastry to rozwiązanie oświetleniowe do wnętrz biurowych i przemysłowych. Świetłówki LED przyczyniają się dodatkowo do mniejszego zużycia energii.

oprawy są przeznaczone do źródeł światła T8 LED 220-240 V ~; 50/60Hz z zasilaniem jednostronnym
odbłyśnik w kształcie półparaboli, poprzeczki rastra w kształcie „V”
gniazda świetlówek zamaskowane odbłyśnikiem
oprawy przystosowane do zwieszenia na zawieszacach
łatwy montaż rastra na zaczepach sprężynujących
malowana proszkowo
Materiał obudowy: stal
Materiał odbłyśnika: stop aluminium

Kanlux NOTUS 4LED luminaires are façade raster luminaires adapted to T8 LED fluorescent lamps. They are manufactured in Poland of components provided by Polish suppliers. Raster lighting is a solution for office and industrial interiors. Additionally, LED fluorescent lamps contribute to lower energy consumption.

the fittings are intended for sources T8 LED 220-240 V ~; 50/60 Hz with one-sided power supply
half-parabolic reflector / V-shaped grille cross-bars
fluorescent lamp sockets concealed with a reflector
light fixtures designed for handing on slings
easy installation of the grille on spring hooks
powder coating
Enclosure material: steel
Reflector material: aluminum alloy



NOTUS 4LED 418 NT



NOTUS 4LED 418 NT | 22671 | 5905339226716 | 4 x max 18 | T8 LED | G13 | biały | white
NOTUS 4LED 236 NT | 22672 | 5905339226723 | 2 x max 36 | T8 LED | G13 | biały | white

[V] 220-240 AC	[Hz] 50/60	T8 LED	L N ONE SIDE INPUT	Light bulb icon	IP 20	House icon	5+25	Mounting icon
Box icon	1+2,5	0,5m	CE	ERL	Kanlux logo			

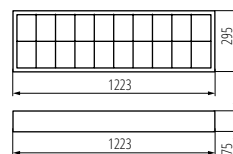

NOTUS 4LED 236 NT

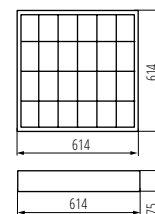

NOTUS 4LED 418 NT

Kanlux NOTUS

OPRAWA RASTROWA NATYNKOWA ► SURFACE-MOUNTED LOUVER FITTING



NOTUS 3 EVG 418 NT; NOTUS 3WS EVG 418 NT



NOTUS 3 EVG 236 NT; NOTUS 3WS EVG 236 NT



NOTUS 3 EVG 218 NT



NOTUS 3 EVG 418 NT	19731	5905339197313	4 x 18	T8	G13	biały white
NOTUS 3 EVG 236 NT	19732	5905339197320	2 x 36	T8	G13	biały white
NOTUS 3 EVG 218 NT	19733	5905339197337	2 x 18	T8	G13	biały white
NOTUS 3WS EVG 418 NT	25711	5905339257116	4 x 18	T8	G13	biały white
NOTUS 3WS EVG 236 NT	25712	5905339257123	2 x 36	T8	G13	biały white

[V] 220-240 AC	[Hz] 50/60	T8	Light bulb icon	Grounding symbol	IP 20	House icon	Temperature icon 5+25	Mounting icon	Ballast icon
1+2,5	EVG BALLAST	0,5m	CE	EMC					

AKCESORIA ► ACCESSORIES

ROPE-NT 150	07870	5905339078704	ROPE-NT 150 linka stalowa (podwójna) do zwieszania opraw, 2 szt w komplecie / ROPE-NT 150 steel rope (double) for suspending fittings, 2 pcs. in a set
ROPE-NT 150 SINGLE	07871	5905339078711	ROPE-NT 150 SINGLE linka stalowa (pojedyncza) do zwieszania opraw, 2 szt w komplecie / ROPE-NT 150 SINGLE steel rope (single) for suspending fittings, 2 pcs. in a set

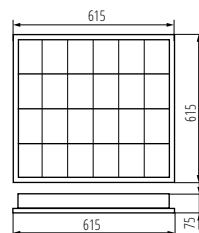

NOTUS 3 EVG 418; NOTUS 3WS EVG 418

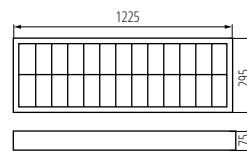

NOTUS 3 EVG 236; NOTUS 3WS EVG 236

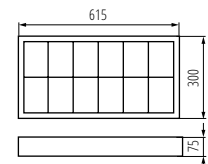

NOTUS 3 EVG 218 NT



Kanlux NOTUS to oprawy rastrowe natynkowe, które charakteryzują się łatwym i szybkim montażem. Rastry to ciągle bardzo popularne rozwiązanie oświetleniowe wnętrz biurowych czy przemysłowych. To za sprawą dobrych parametrów świetlnych przy dobrej cenie, prostej konstrukcji i odporności materiałów z jakich są wykonane.

odbłyśnik w kształcie półparaboli, poprzeczki rastra w kształcie „V”
gniazda świetlówek zamaskowane odbłyśnikami
oprawy przystosowane do zwieszania na zawieszach
statecznik marki OSRAM w klasie A2
łatwy montaż rastra na zaczepach sprężynujących
szybkoszłączka, do podłączenia zasilania, ułatwia i przyspiesza montaż, malowanie proszkowe
NOTUS 3WS wyposażony w statecznik z „cieplem startem”
Materiał obudowy: stal
Materiał odbłyśnika: stop aluminium

Kanlux NOTUS are raster facade luminaires that can be mounted quickly and easily. Raster lighting is still a very popular solution for office and industrial spaces. It is all due to good lighting parameters at a good price, simple construction and durability of the materials of which they are made.

half-parabolic reflector / V-shaped grille cross-bars
fluorescent lamp sockets concealed with a reflector
light fixtures designed for hanging on slings
Class A2 OSRAM ballast
easy installation of the grille on spring hooks
quick coupling for connecting the power supply, easier and quicker installation, powder coating
NOTUS 3WS equipped with a „warm start” ballast
Enclosure material: steel
Reflector material: aluminum alloy

NOTUS PREMIUM

OPRAWA RASTROWA NATYNKOWA ► SURFACE-MOUNTED LOUVER FITTING



NOTUS PREMIUM 418 NT



NOTUS PREMIUM 418 NT



NOTUS PREMIUM 236 NT



Oprawy Kanlux NOTUS PREMIUM to oprawy rastrowe, natynkowe przeznaczone dla wymagających inwestycji. Od klasycznej wersji różnią się przede wszystkim wyglądem. Ich kształt charakteryzuje się ściętymi bokami i zaokrąglonymi narożnikami, które sprawiają, że oprawy zyskują nowoczesny wygląd.

odbłyśnik w kształcie półparaboli, poprzeczki rastra w kształcie „V”
gniazda świetlówek zamaskowane odbłyśnikiem
oprawy przystosowane do zwieszenia na zawieszakiach
łatwy montaż rastra na zaczepach sprężynujących
szybkoszczka, do podłączenia zasilania, ułatwia i przyspiesza montaż, malowanie proszkowe, malowanie proszkowe, podwójnie gięte boki, zaokrąglone narożniki
statecznik marki OSRAM w klasie A2

Materiał obudowy: stal

Materiał odbłyśnika: stop aluminium

Kanlux NOTUS PREMIUM are façade raster luminaires designed for demanding investment. They differ from the classic version mainly with their appearance. Their shape is characterised by bevelled edges and rounded corners which give the luminaires the modern appearance.

half-parabolic reflector / V-shaped grille cross-bars

fluorescent lamp sockets concealed with a reflector

light fixtures designed for hanging on slings

easy installation of the grille on spring hooks

quick coupling for connecting the power supply, easier and quicker installation, powder coating, double-folded side panels, rounded corners

Class A2 OSRAM ballast

Enclosure material: steel

Reflector material: aluminum alloy



NOTUS PREMIUM 236 NT	22290	5905339222909	2 x 36	T8	G13	biały white
NOTUS PREMIUM 418 NT	22291	5905339222916	4 x 18	T8	G13	biały white

[V] 220-240 AC	[Hz] 50/60	T8			IP 20		 5+25		
 1+2,5	EVG BALLAST	 0,5m	CE	ERC					

AKCESORIA ► ACCESSORIES

ROPE-NT 150	07870	5905339078704	ROPE-NT 150 linka stalowa (podwójna) do zwieszania opraw, 2 szt w komplecie / ROPE-NT 150 steel rope (double) for suspending fittings, 2 pcs. in a set			
ROPE-NT 150 SINGLE	07871	5905339078711	ROPE-NT 150 SINGLE linka stalowa (pojedyncza) do zwieszania opraw, 2 szt w komplecie / ROPE-NT 150 SINGLE steel rope (single) for suspending fittings, 2 pcs. in a set			

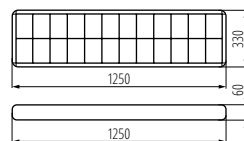

NOTUS PREMIUM 236 NT

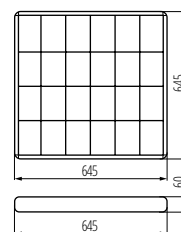

NOTUS PREMIUM 418 NT

Kanlux REGIS

OPRAWA RASTROWA PODTYNKOWA ▶ RECESSED LOUVER FITTING



REGIS 3 EVG 418 PT / REGIS 3WS EVG 418 PT



Kanlux REGIS to oprawy rastrowe podtynkowe, które dzięki zaczepom sprężynującym i szybkozłączkom charakteryzują się łatwym i szybkim montażem. Rastry to ciągle bardzo popularne rozwiązanie oświetleniowe wewnątrz biurowych czy przemysłowych.

odbłyśnik w kształcie półparaboli / poprzeczki rastra w kształcie „V” / gniazda świetlówek zamaskowane odbłyśnikiem (wyjątkiem jest wersja REGIS 3 OPAL, REGIS 3WS OPAL która ma płytę opal)

w obudowie otwory ułatwiające zasilanie przelotowe

przewód ochronny na rastrze, dodatkowo zabezpieczający przed porażeniem elektrycznym za wyjątkiem wersji REGIS 3 OPAL, REGIS 3WS OPAL.

łatwy montaż rastra na zaczepach sprężynujących

szybkozłączka, do podłączenia zasilania, ułatwia i przyspiesza montaż, statecznik marki OSRAM w klasie A2 malowanie proszkowe

REGIS 3WS wyposażony w statecznik z „ciepłym startem”.

Materiał obudowy: stal

Materiał odbłyśnika: stop aluminium

Kanlux REGIS are raster recessed luminaires that can be mounted quickly and easily with spring clips and quick couplings. Raster lighting is still a very popular solution for office and industrial spaces.

reflector in the shape of a half-parabola / raster crossbars in the shape of “V” / sockets of fluorescent lamps masked with a reflector (exception: version REGIS 3 OPAL, REGIS 3WS OPAL with an opal board)

the casing contains openings facilitating straight through type power supply

protective cable on a raster, additionally securing against electric shock, except the version REGIS 3 OPAL, REGIS 3WS OPAL.

simple assembly of the raster on spring catches

quick coupling, for connection of power supply, facilitates and accelerates assembly, stabilizer by OSRAM in A2 class

powder coating

REGIS 3WS equipped with a stabilizer with “warm start”.

Enclosure material: steel

Reflector material: aluminum alloy



REGIS 3 EVG 418 PT; REGIS 3WS EVG 418 PT

REGIS 3 OPAL 418 PT; REGIS 3WS OPAL 418 PT



REGIS 3 EVG 418 PT	19730	5905339197306	4 x 18	T8	G13	20	biały white
REGIS 3 OPAL 418 PT	19734	5905339197344	4 x 18	T8	G13	40	biały white
REGIS 3WS EVG 418 PT	25710	5905339257109	4 x 18	T8	G13	20	biały white
REGIS 3WS OPAL 418 PT	25713	5905339257130	4 x 18	T8	G13	40	biały white

[V]	[Hz]	T8	Light bulb icon	Grounding icon	House icon	Temperature icon 5+25	Arrow icon	Box icon	[mm]
220-240 AC	50/60	T8							1+2,5
EVG BALLAST	0,5m	CE	EAC	Kanlux logo and A-E classification					

AKCESORIA ▶ ACCESSORIES

CLP-REGIS/PT	72333	5905339723338	CLP-REGIS/PT wspornik montażowy, służy do wbudowania opraw w gips-kartonowym suficie podwieszanym. 4szt w komplecie. / CLP-REGIS/PT mounting support, used for building in fittings in a plasterboard suspended ceiling. 4 pcs. in a set.				
--------------	-------	---------------	---	--	--	--	--

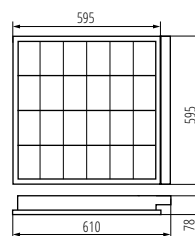

REGIS 3 EVG 418 PT; REGIS 3WS EVG 418 PT

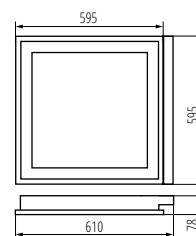

REGIS 3 OPAL 418 PT; REGIS 3WS OPAL 418 PT

Kanlux

REGIS 4LED

OPRAWA RASTROWA PODTYNKOWA ► RECESSED LOUVER FITTING



REGIS 4LED 418 PT



REGIS 4LED 418 PT



REGIS 4LED OPAL 418PT



Oprawy Kanlux REGIS 4LED to tradycyjne oprawy rastrowe podtynkowe, przystosowane do świetlówek ledowych T8. Produkowane są w Polsce, z komponentów od polskich dostawców. Rastry to ciągle bardzo popularne rozwiązanie oświetleniowe wnętrz biurowych czy przemysłowych.

oprawy są przeznaczone do źródeł światła T8 LED 220-240 V ~; 50/60Hz z zasilaniem jednostronnym

oprawy przystosowane do zwieszenia na zawieszach

łatwy montaż rastra na zaczepach sprężynujących

malowana proszkowo

Materiał obudowy: stal

Kanlux REGIS 4LED luminaires are traditional raster recessed luminaires adapted to T8 LED fluorescent lamps. They are manufactured in Poland of components provided by Polish suppliers. Raster lighting is still a very popular solution for office and industrial spaces.

the fittings are intended for light sources T8 LED 220-240 V ~; 50/60Hz with one-sided power supply

fittings adapted to suspension on slings

simple assembly of the raster on spring catches

powder coated

Enclosure material: steel



REGIS 4LED OPAL 418PT	19736	5905339197368	4 x max 18	T8 LED	G13	biały white
REGIS 4LED 418 PT	22673	5905339226730	4 x max 18	T8 LED	G13	biały white

[V] 220-240 AC	[Hz] 50/60	T8 LED	ONE SIDE INPUT	IP 20	5+25	CE	EAC	Kanlux
1+2,5	0,5m	CE	EAC	Kanlux	A+	A+	A+	A+

AKCESORIA ► ACCESSORIES

CLP-REGIS/PT	72333	5905339723338	CLP-REGIS/PT wspornik montażowy, służy do wbudowania opraw w gips-kartonowym suficie podwieszanym. 4szt w komplecie. / CLP-REGIS/PT mounting support, used for building in fittings in a plasterboard suspended ceiling. 4 pcs. in a set.			
--------------	--------------	---------------	---	--	--	--

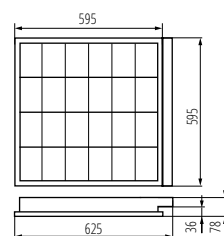

REGIS 4LED 418 PT

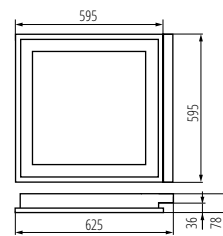

REGIS 4LED OPAL 418PT

AVAR LED

RAMKA OŚWIETLENIOWA LED ► LED LIGHTING FRAME



AVAR 6060 40W



AVAR 6060 40W

AVAR 6262 40W



Panele LED są bardzo popularnym elementem oświetleniowym wewnątrz biurowych. W dużej mierze zastąpiły oprawy rastrowe dzięki swojej trwałości, energooszczędności i estetyce. Kanlux AVAR LED to nowy kierunek paneli LED, którego wyznacznikiem jest nie tylko nowoczesna technologia, ale i sam kształt w formie ramki, która zapewnia mocne i efektowne światło.

AVAR 62x62 przeznaczony jest do alternatywnego rozmiaru systemów sufitowych (625mmx625mm)

Materiał obudowy: stop aluminium

Materiał klosza: tworzywo sztuczne

Materiał panelu/ramki: stop aluminium

LED panels are very popular lighting elements in office interiors. Due to their durability, energy efficiency and aesthetics, they have replaced extent raster luminaires to a large. Kanlux AVAR LED is a new dimension in LED panels distinguished by modern technology and the shape of frame which emits intense and impressive light.

AVAR 62x62 is intended for an alternative size of ceiling systems (625mmx625mm)

Enclosure material: aluminum alloy

Lampshade material: plastic

Panel/frame material: aluminum alloy

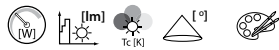

AVAR 6060 40W-NW	26770	5905339267702	40	3600	4000	110	biały white
AVAR 6060 40W-CW	26771	5905339267719	40	3800	6000	110	biały white
AVAR 6060 40W-WW	26772	5905339267726	40	3400	3000	110	biały white
AVAR 6262 40W-NW	26773	5905339267733	40	3600	4000	110	biały white
AVAR 6262 40W-WW	26774	5905339267740	40	3400	3000	110	biały white

[V] 220-240 AC	[Hz] 50/60	[lm] ≥15000	[h] 25000	[Ra] ≥80	[SMD]	[IP] 20	[°] 5+25
[mm] 0,75	[m] 0,5m	[m] 0,5m	[m] 0,5m	[m] 0,5m	[m] 0,5m	[m] 0,5m	[m] 0,5m

AKCESORIA ► ACCESSORIES

AVAR DALI SET 40W	28512	5905339285126	Zestaw zawierający akcesoria i zasilacz umożliwiający komunikację zgodnie z protokołem DALI (28512) / Set containing accessories and a power supply unit enabling communication in line with DALI protocol (28512)
-------------------	--------------	---------------	---

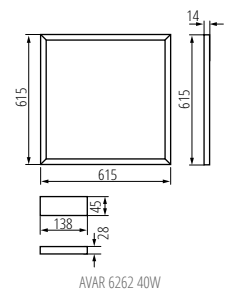
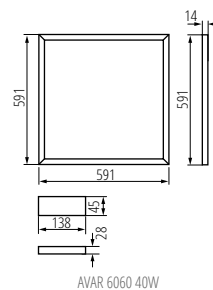

Kanlux

KRALA LED

OPRAWA PYŁOSZCZELNA LED ► LED DUSTPROOF LIGHTING FITTING



KRALA LED 45W



KRALA LED 45W NW | **28270** | 5905339282705 | 45 | 5850 | 4000 | 120 | biały | white

[V] 220-240 AC	[Hz] 50/60	cos φ 0,9	[h] ≥25000	[h] 30000	[lm] ≥25000	[Ra] ≥80	[SMD]	[IP] 65	[Temp] -20+40	[IK] IK 08	[Dist] 0,5m	[CE]	[EAC]
-------------------	---------------	--------------	---------------	--------------	----------------	-------------	-------	------------	------------------	---------------	----------------	------	-------



AKCESORIA ► ACCESSORIES

KRALA CORD-2M	28275	Linki stalowe do zwieszenia oprawy 2m - (2 szt w komplecie) Steel cord for hanging the fixture 2m - (2 pcs. included)
KRALA PLUG-1M	28271	Przewód zasilający z wtyczką 1m Power cord with plug 1m
KRALA PP-0,35M	28274	Łącznik giętki 0,35m Flexible connector 0.35m
KRALA PP-1M	28273	Łącznik giętki 1m Flexible connector 1m
KRALA PR-I	28272	Łącznik sztywny Rigid connector



Kanlux KRALA to szczelna oprawa LED, która daje możliwości tworzenia linii świetlnych i tworzenia w nich dowolnych kątów za pomocą giętkiego łącznika. Innowacyjna konstrukcja, wysoka skuteczność świetlna i szybki montaż to tylko niektóre z jej atutów.

Brak przewodu zasilającego w komplecie. Rekomendowany przewód: KRALA PLUG-1M kod 28271

5 lat Gwarancji na warunkach oświadczenia gwarancyjnego, dostępnego na stronie internetowej

Materiał obudowy: tworzywo sztuczne
Materiał klosza: tworzywo sztuczne

Kanlux KRALA is a tight LED fixture, which gives the possibility to create lighting lines and position them at any angle thanks to the flexible connector. Innovative design, high light efficiency and quick installation are just some of its advantages.

No power supply cable included. Recommended cable: KRALA PLUG-1M, code 28271.

5 years Warranty under the terms of the warranty statement, available on our website

Enclosure material: plastic
Lampshade material: plastic

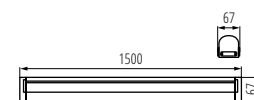

KRALA LED 45W

MAH LED N

OPRAWA PYŁOSZCZELNA LED ► LED DUSTPROOF LIGHTING FITTING



MAH-LED N 20W-NW/PC



MAH-LED N 20W-NW/PC



MAH-LED N 40W-NW/PC



MAH-LED N 50W-NW/PC



MAH-LED N 20W-NW/PC	22603	5905339226037	20	2100	4000	X135/Y100	szary grey
MAH-LED N 40W-NW/PC	22604	5905339226044	40	4200	4000	X135/Y100	szary grey
MAH-LED N 50W-NW/PC	22605	5905339226051	50	5250	4000	X135/Y100	szary grey



Kanlux MAH LED N to oprawy hermetyczne przeznaczone dla bardziej wymagających użytkowników. Cechuje je wyjątkowa skuteczność świetlna dochodząca do 105 lm/W i możliwość łączenia w linie nawet 15 opraw (w zależności od modelu), co umożliwia oświetlenie dużych powierzchni.



Materiał obudowy: PC
Materiał klosza: PC



Kanlux MAH LED N are hermetic luminaires designed for more demanding users. They are characterised by unique luminous efficacy reaching 105 lm/W and the possibility of connecting them in lines of even 15 luminaires (depending on the model), which allows for lighting of large spaces.

Enclosure material: PC
Lampshade material: PC

[V] 220-240 AC	[Hz] 50/60	[h] ≥15000	[h] 30000	[lm] ≤60 MacAdam	Ra ≥80	SMD	IP 65
[°C] -20+40	IK 08	[mm] 1,5+2,5	[mm] 0,5m	CE	ERL	Kanlux	

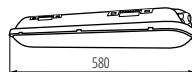

MAH-LED N 20W

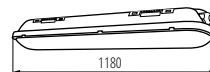

MAH-LED N 40W

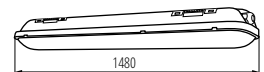

MAH-LED N 50W

Kanlux

MAH PLUS 4LED

OPRAWA PYŁOSZCZELNA POD TUBY LED ▶ DUST-PROOF LED TUBE LIGHT FITTING



MAH PLUS-236/4LED/PC



MAH PLUS-236/4LED/PC



MAH PLUS-258/4LED/PC



Kanlux MAH PLUS 4LED to ledowe odpowiedniki popularnych opraw. Ich głównym atutem jest fakt, że można zastosować w nich ledowe źródła światła T8 o długościach 600 mm lub 1200 mm. Jest to doskonale rozwiązanie dla zastosowań przemysłowych.

oprawy MAH PLUS 4LED/PC są przeznaczone do źródeł T8 LED 220-240 V-; 50/60 Hz z zasilaniem jednostronnym

Atest PZH: Numer BK/K/0024/01/2019, ważny do 2024-03-12

Materiał obudowy: tworzywo sztuczne

Materiał klosza: PC

Materiał zapinek: tworzywo sztuczne

Kanlux MAH PLUS 4LED are LED equivalents of popular luminaires. Their core asset consists in the fact that they can use T8 LED light sources that are 600 mm or 1200 mm long. This solution is perfect for industrial use.

MAH PLUS 4 LEDs/PC light fixtures are designed for T8 LED 220-240 V-; 50/60 Hz light sources with one-sided power supply

Enclosure material: plastic

Lampshade material: PC

Clasp material: plastic



MAH PLUS-236/4LED/PC	22800	5905339228000	2 x max 36	T8 LED	G13	szary grey
MAH PLUS-258/4LED/PC	22801	5905339228017	2 x max 58	T8 LED	G13	szary grey

[V] 220-240 AC	[Hz] 50/60	T8 LED	IP 65	5+25	1+2,5	ONE SIDE INPUT	0,5m	CE	ERL	Kanlux
-------------------	---------------	--------	----------	------	-------	----------------	------	----	-----	--------

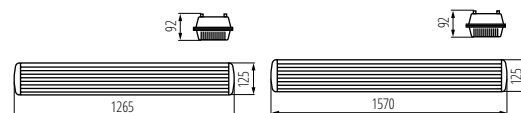

MAH PLUS-236/4LED/PC

MAH PLUS-258/4LED/PC

MAH PLUS

OPRAWA PYŁOSZCZELNA ► DUSTPROOF LIGHTING FITTING



MAH PLUS-118-ABS



MAH PLUS-218-ABS



MAH PLUS-236-ABS/PC



Oprawy pyłoszczelne Kanlux MAH PLUS doskonale sprawdzą się jako oświetlenie tuneli, hal przemysłowych, garaży, pomieszczeń warsztatowych, wiat składowych lub magazynów. Wysoka klasa szczelności IP65 sprawia, że oprawy te można montować w miejscach bezpośrednio narażonych na działanie czynników atmosferycznych.

Łatwy montaż oprawy do podłoża przy użyciu dołączonych zatrzaskowych uchwytych mocujących

podwieszana płyta montażowa ułatwiająca podłączenie i serwis oprawy

uszczelniający dławik, służący do wprowadzenia przewodu zasilającego

Materiał obudowy: tworzywo sztuczne

Materiał zapinek: tworzywo sztuczne

Materiał uchwyty: metal

Kanlux MAH PLUS are perfect as lighting of tunnels, industrial halls, garages, workshops, storage sheds or storehouses. Owing to the high class of tightness (IP65), the luminaires can be mounted in places directly exposed to weather conditions.

easy installation of the light fixture using the supplied snap-on mounting brackets

suspended mounting plate for easier connection and maintenance of the light fixture

barrier gland for inserting a power cable

Enclosure material: plastic

Clasp material: plastic

Handle material: Metal



MAH PLUS-118-ABS/PC	18515	5905339185150	18	T8	G13	szary grey
MAH PLUS-218-ABS/PS	18516	5905339185167	2 x 18	T8	G13	szary grey
MAH PLUS-218-ABS/PC	18517	5905339185174	2 x 18	T8	G13	szary grey
MAH PLUS-136-ABS/PS	18518	5905339185181	36	T8	G13	szary grey
MAH PLUS-136-ABS/PC	18519	5905339185198	36	T8	G13	szary grey
MAH PLUS-236-ABS/PS	18520	5905339185204	2 x 36	T8	G13	szary grey
MAH PLUS-236-ABS/PC	18521	5905339185211	2 x 36	T8	G13	szary grey
MAH PLUS-158-ABS/PC	18523	5905339185235	58	T8	G13	szary grey
MAH PLUS-258-ABS/PS	18524	5905339185242	2 x 58	T8	G13	szary grey
MAH PLUS-258-ABS/PC	18525	5905339185259	2 x 58	T8	G13	szary grey

[V] 220-240 AC	[Hz] 50/60				IP 65			
	EVG BALLAST			CE	ERC			
	1+2,5	0,5m						

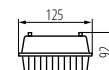

MAH PLUS-258-ABS/PC



MAH PLUS-118-ABS

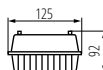

MAH PLUS-218-ABS



MAH PLUS-136-ABS

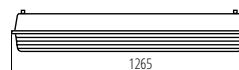
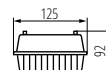

MAH PLUS-236-ABS



MAH PLUS-158-ABS

MAH PLUS

OPRAWA PYŁOSZCZELNA ► DUSTPROOF LIGHTING FITTING



AKCESORIA ► ACCESSORIES

GL-MAH-136 PLUS-PC	18589	5905339185891	Klosz oprawy MAH, GL-MAH-136 PLUS-PC, (18589) / Fitting shade MAH, GL-MAH-136 PLUS-PC, (18589)
GL-MAH-136 PLUS-PS	18588	5905339185884	Klosz oprawy MAH, GL-MAH-136 PLUS-PS, (18588) / Fitting shade MAH, GL-MAH-136 PLUS-PS, (18588)
GL-MAH-158 PLUS-PC	18596	5905339185969	Klosz oprawy MAH, GL-MAH-158 PLUS-PC, (18596) / Fitting shade MAH, GL-MAH-158 PLUS-PC, (18596)
GL-MAH-158 PLUS-PS	18595	5905339185952	Klosz oprawy MAH, GL-MAH-158 PLUS-PS, (18595) / Fitting shade MAH, GL-MAH-158 PLUS-PS, (18595)
GL-MAH-218 PLUS-PC	18587	5905339185877	Klosz oprawy MAH, GL-MAH-218 PLUS-PC, (18587) / Fitting shade MAH, GL-MAH-218 PLUS-PC, (18587)
GL-MAH-218 PLUS-PS	18586	5905339185860	Klosz oprawy MAH, GL-MAH-218 PLUS-PS, (18586) / Fitting shade MAH, GL-MAH-218 PLUS-PS, (18586)
GL-MAH-236 PLUS-PC	18591	5905339185914	Klosz oprawy MAH, GL-MAH-236 PLUS-PC, (18591) / Fitting shade MAH, GL-MAH-236 PLUS-PC, (18591)
GL-MAH-236 PLUS-PS	18592	5905339185921	Klosz oprawy MAH, GL-MAH-236 PLUS-PS, (18592) / Fitting shade MAH, GL-MAH-236 PLUS-PS, (18592)
GL-MAH-258 PLUS-PS	18597	5905339185976	Klosz oprawy MAH, GL-MAH-258 PLUS-PS, (18597) / Fitting shade MAH, GL-MAH-258 PLUS-PS, (18597)
CL-MAH PLUS	18593	5905339185938	Klips oprawy MAH, CL-MAH PLUS, (18593) / Fitting clip MAH, CL-MAH PLUS, (18593)
CL-MAH PLUS-INOX	18594	5905339185945	Klips oprawy MAH, CL-MAH PLUS-INOX, (18594) / Fitting clip MAH, CL-MAH PLUS-INOX, (18594)
ROPE-NT 150	07870	5905339078704	ROPE-NT 150 linka stalowa (podwójna) do zwieszania opraw, 2 szt w komplecie / ROPE-NT 150 steel rope (double) for suspending fittings, 2 pcs. in a set
ROPE-NT 150 SINGLE	07871	5905339078711	ROPE-NT 150 SINGLE linka stalowa (pojedyncza) do zwieszania opraw, 2 szt w komplecie / ROPE-NT 150 SINGLE steel rope (single) for suspending fittings, 2 pcs. in a set



ANDER LED

OPRAWA PYŁOSZCZELNA LED ► LED DUSTPROOF LIGHTING FITTING



ANDER LED 60W-NW



Kanlux ANDER LED to wodoodporna oraz pyłoszczelna oprawa (IP66), która doskonale sprawdzi się w obiektach przemysłowych. Charakteryzują się wysoką trwałością źródła światła, wynoszącą 50 000 h. Ma to bardzo duże znaczenie w miejscach trudno dostępnych, takich jak na przykład magazyny wysokiego składowania, czy hale produkcyjne.

5 lat Gwarancji na warunkach oświadczenia gwarancyjnego, dostępnego na stronie internetowej

Atest PZH: Numer BK/K/0536/02/2018, ważny do 2023-09-19

Materiał obudowy: stop aluminium, stal

Materiał klosza: szkło

Kanlux ANDER LED is a waterproof and dustproof luminaire (IP66), a smart choice for industrial spaces. They are characterised by high durability of the light source amounting to 50,000 hrs, which is very important in places hard to reach, such as high-storage units or production halls.

5 years Warranty under the terms of the warranty statement, available on our website

Enclosure material: aluminum alloy, steel

Lampshade material: glass



ANDER LED 60W-NW | **27110** | 5905339271105 | 60 | szary | grey | 7200 | 110 | 4000

[V] 220-240 AC	[Hz] 50/60	[h] ≥25000	[h] 50000	Beam angle ≤ 60° Max/Beam	Ra ≥80	SMD	IP 66
[-30+40]	[IK] 07	[mm] 1,5+2,5	[mm] 0,5m	[CE]	[EAC]		

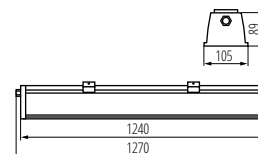

ANDER LED 60W-NW

TP SLIM LED

OPRAWA LINIOWA LED ► LINEAR LED LUMINAIRE



TP SLIM LED 40W; 50W-NW



TP SLIM LED 40W-NW



TP SLIM LED 50W-NW

LED
technology

EASY
installation

up to

110 lm/W

IP65



Kanlux TP SLIM LED to niewielka oprawa hermetyczna, którą możemy zamontować natynkowo lub w formie zwieszanej. Wygodę montażu zapewniają regulowane uchwyty i szybkozłączki. Dzięki klasie szczelności IP65 i odporności na uderzenia IK 08 mamy możliwość zastosowania oprawy w takich miejscach jak: pomieszczenia przemysłowe, magazyny, parkingi i garaże.

Materiał obudowy: tworzywo sztuczne
Materiał klosza: tworzywo sztuczne

Kanlux TP SLIM LED is a small hermetic fitting which can be mounted on a surface or in a suspended form. Assembly is convenient thanks to adjustable holders and quick couplings. Owing to IP65 tightness class and IK 08 resistance to impact, you can use the fitting in such places as: industrial rooms, warehouses, car parks and garages.

Enclosure material: plastic
Lampshade material: plastic

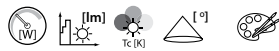

TP SLIM LED 40W-NW	27115	5905339271150	40	4400	4000	120	biały white
TP SLIM LED 50W-NW	27116	5905339271167	50	5500	4000	120	biały white

[V] 220-240 AC	[Hz] 50/60	lm/W 110	≥ 20000	25000	$\leq 6^\circ$ Maxdram	$R_a \geq 80$	SMD		
IP 65		$-20 \sim +40$			1-2,5	0,5m		CE	ERAC

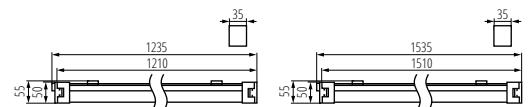

TP SLIM LED 40W-NW

TP SLIM LED 50W-NW

Kanlux NOME N

OPRAWA LINIOWA LED ► LINEAR LED LUMINAIRE



NOME N LED SMD 18W-NW



NOME N LED SMD 18W-NW	25493	5905339254931	18	1800	4000	120	biały white
NOME N LED SMD 36W-NW	25494	5905339254948	36	3600	4000	120	biały white
NOME N LED SMD 48W-NW	25495	5905339254955	48	4800	4000	120	biały white

[V] 220-240 AC	[Hz] 50/60	≥20000	[h] 25000	ellipse ≤ 6x MacAdam	Ra ≥80	SMD
IP 65	1+2,5	0,5m	CE	ERC	Kanlux	

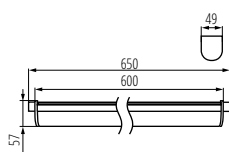

NOME N LED SMD 18W

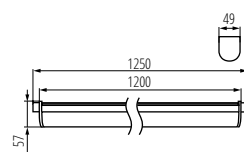

NOME N LED SMD 36W

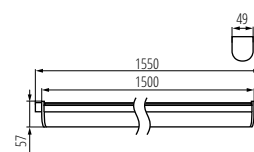

NOME N LED SMD 48W



Oprawy liniowe Kanlux NOME N możemy w prosty sposób połączyć ze sobą tworząc segmenty światła. Oprawy przeznaczone są do oświetlenia pomieszczeń o dużej wilgotności i zapyleniu (IP65), np.: hal produkcyjnych, magazynów, pomieszczeń warsztatowych i podobnych.

Oprawa okablowana przelotowo, 2 dławiki PG11 w oprawie, możliwość łączenia przelotowego opraw
Materiał obudowy: PC
Materiał klosza: PC

Kanlux NOME N linear luminaires can be easily connected to create light segments. The luminaires are designed for lighting rooms of high humidity and dustiness (IP65), e.g.: production halls, storehouses, workshops, etc.

Fitting with pass-through installation, 2 chokes PG11 in the fitting, possibility of connecting the fittings in-line
Enclosure material: PC
Lampshade material: PC

Kanlux LINER LED

OPRAWA LINIOWA LED ► LINEAR LED LUMINAIRE



LINER LED 18W; 36W



Dzięki oprawom Kanlux LINER możemy w szybki i prosty sposób tworzyć ledowe linie świetlne. Umożliwia to nam minimalistyczna konstrukcja oprawy i łączenie typu „klik”, co pozwala na bezpośrednie łączenie opraw, bez zbędnego okablowania. Oprawy Kanlux LINER przeznaczone są do użytku wewnętrznego (IP20).

Możliwość bezprzewodowego łączenia w linie
Materiał obudowy: PC
Materiał klosza: PC

Owing to Kanlux LINER luminaires, we can make LED light lines in a simple and quick way. This is possible due to the minimalist design of the luminaire and its “click” connection, which allows for direct connecting of luminaires without unnecessary cables. Kanlux LINER luminaires are designed for indoor use (IP20).

Possibility of wireless connection in a line
Enclosure material: PC
Lampshade material: PC

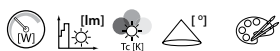

LINER LED 18W-NW	27260	5905339272607	18	1600	4000	120	biały white
LINER LED 36W-NW	27261	5905339272614	36	3200	4000	120	biały white

[V] 220-240 AC	[Hz] 50/60	≥15000	[h] 30000	ellipse ≤ 6x MacAdam	Ra ≥80	SMD
IP 20	IK 08	0,3	0,75	0,5m	CE	ERC



LINER LED 18W-NW

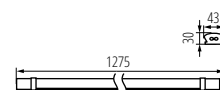

LINER LED 36W-NW

ALDO 4LED

OPRAWA LINIOWA POD TUBY LED T8 ▶ T8 LED TUBE LINEAR FITTINGS



ALDO 4LED 1X60; 1X120; 1X150



ALDO 4LED 1X60R; 1X120R; 1X150R



ALDO 4LED 2X60; 2X120; 2X150



ALDO 4LED 2X60R; 2X120R; 2X150R



Model	Code	Part No.	Length	Tube	Base	Color
ALDO 4LED 1X60	26360	5905339263605	max 18	T8 LED	G13	biały white
ALDO 4LED 1X120	26361	5905339263612	max 36	T8 LED	G13	biały white
ALDO 4LED 1X150	26362	5905339263629	max 58	T8 LED	G13	biały white
ALDO 4LED 2X60	26363	5905339263636	2 x max 18	T8 LED	G13	biały white
ALDO 4LED 2X120	26364	5905339263643	2 x max 36	T8 LED	G13	biały white
ALDO 4LED 2X150	26365	5905339263650	2 x max 58	T8 LED	G13	biały white
ALDO 4LED 1X60R	26370	5905339263704	max 18	T8 LED	G13	biały white
ALDO 4LED 1X120R	26371	5905339263711	max 36	T8 LED	G13	biały white
ALDO 4LED 1X150R	26372	5905339263728	max 58	T8 LED	G13	biały white
ALDO 4LED 2X60R	26373	5905339263735	2 x max 18	T8 LED	G13	biały white
ALDO 4LED 2X120R	26374	5905339263742	2 x max 36	T8 LED	G13	biały white
ALDO 4LED 2X150R	26375	5905339263759	2 x max 58	T8 LED	G13	biały white

[V] 220-240 AC	[Hz] 50/60	T8 LED	⊕	IP 20	°C 5+25	⌞	⊞	[mm] 0,5-2,5	L N ⊞ ONE SIDE INPUT
0,5m	⚡	CE	ERL						

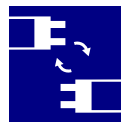

Kanlux ALDO 4LED to rodzina belek oświetleniowych przystosowanych do świetlówek ledowych T8. Są to oprawy ścienna-sufitowe charakteryzujące się nowoczesnym, opływowym kształtem, przez co dyskretnie wpasują się w każdą aranżację wnętrza.

Oprawy są przeznaczone do źródeł T8 LED 220-240 V-; 50/60 Hz z zasilaniem jednostronnym

ALDO R wyposażona w odbłyśnik

Materiał obudowy: metal, tworzywo sztuczne

Kanlux ALDO 4LED are a family of batten luminaires adapted to T8 LED fluorescent lamps. They are wall and ceiling luminaires characterised by modern, streamlined shape so they fit discreetly in each interior arrangement. Kanlux ALDO 4LED are a family of batten luminaires adapted to T8 LED fluorescent lamps. They are wall and ceiling luminaires characterised by modern, streamlined shape so they fit discreetly in each interior arrangement.

The fittings are intended for sources T8 LED 220-240 V-; 50/60 Hz with one-sided power supply

ALDO R equipped with a reflector

Enclosure material: Metal, plastic

Kanlux

ALDO 4LED

OPRAWA LINIOWA POD TUBY LED T8 ▶ T8 LED TUBE LINEAR FITTINGS

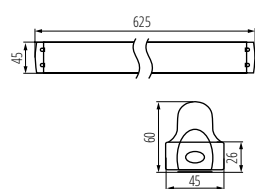

ALDO 4LED 1X60; 1X60R

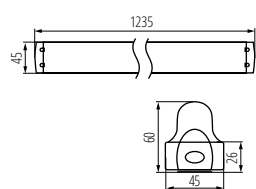

ALDO 4LED 1X120; 1X120R

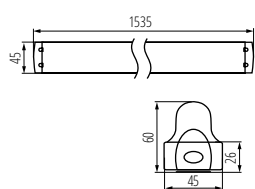

ALDO 4LED 1X150; 1X150R

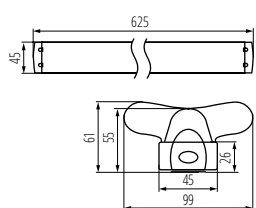

ALDO 4LED 2X60; 2X60R

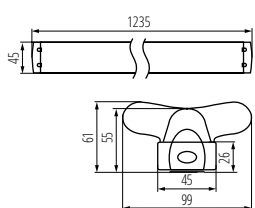

ALDO 4LED 2X120; 2X120R

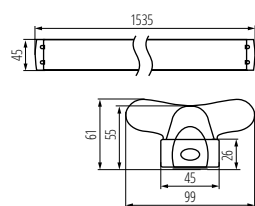

ALDO 4LED 2X150; 2X150R



MEBA 4LED

OPRAWA LINIOWA POD TUBY LED T8 ▶ T8 LED TUBE LINEAR FITTINGS



MEBA 4LED 2X60 PS



MEBA 4LED 2X60 OP PS

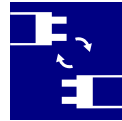

Kanlux MEBA 4LED to ledowa wersja oprawy liniowej Kanlux MEBA. Zastosowane w niej tuby ledowe T8 gwarantują oszczędniejsze i dłuższe działanie, co pozytywnie przekłada się na ich komfort użytkowania w salonach kosmetycznych, fryzjerskich i pomieszczeniach biurowych.

oprawy są przeznaczone do źródeł T8 LED 220-240 V-; 50/60 Hz z zasilaniem jednostronnym

Materiał obudowy: tworzywo sztuczne, stal
Materiał klosza: PS

Kanlux MEBA 4LED is a LED version of Kanlux MEBA linear luminaire. T8 LED tubes used in it guarantee more economical and longer operation, which positively translates into the comfort of use in beauty and hairdresser salons, and office spaces.

the fittings are intended for sources T8 LED 220-240 V-; 50/60 Hz with one-sided power supply

Enclosure material: plastic, steel

Lampshade material: PS



MEBA 4LED 2X120 PS



MEBA 4LED 2X120 OP PS



MEBA 4LED 2X150 PS



MEBA 4LED 2X150 OP PS



MEBA 4LED 2X60 PS	26960	5905339269607	2 x max 18	T8 LED	G13	biały white
MEBA 4LED 2X120 PS	26961	5905339269614	2 x max 36	T8 LED	G13	biały white
MEBA 4LED 2X150 PS	26962	5905339269621	2 x max 58	T8 LED	G13	biały white
MEBA 4LED 2X60 OP PS	26963	5905339269638	2 x max 18	T8 LED	G13	biały white
MEBA 4LED 2X120 OP PS	26964	5905339269645	2 x max 36	T8 LED	G13	biały white
MEBA 4LED 2X150 OP PS	26965	5905339269652	2 x max 58	T8 LED	G13	biały white

[V] 220-240 AC	[Hz] 50/60	T8 LED	IP 20	5+25	1-2,5	0,5m	CE	ERC	Kanlux
--------------------------	----------------------	--------	-------	------	-------	------	----	-----	--------

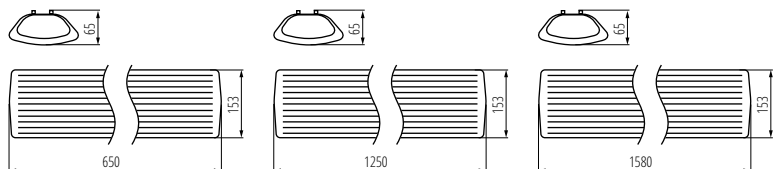

MEBA 4LED 2X60

MEBA 4LED 2X120

MEBA 4LED 2X150

Kanlux

DABA LED ECO

PLAFONIERA LED ► CEILING-MOUNTED LED LIGHT FITTING



DABA LED ECO DL-100



DABA LED ECO DL-100 | **19061** | 5905339190611 | 10 | 520 | 4000 | biały | white | mikrofalowy | microwave

[V] 220-240 AC	[Hz] 50/60	 ≥10000	 20000	 Ra ≥80	 SMD	 micro wave	
IP 40		 5÷25	 IK 07	 max 8	 H360/ V170	 10-12	 micro wave
 3-2000	 0,5m						

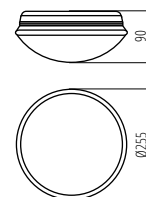

DABA LED ECO DL-100

Oprawa Kanlux DABA LED ECO to plafoniera wykorzystująca diody SMD. Wyposażona jest w mikrofalowy czujnik ruchu, który posiada 8 metrowy zasięg wykrywania ruchu. Czasu świecenia można regulować w zakresie od 10 sek do 12 min.

oprawa wykorzystuje diody LED SMD 3528

wyposażona w mikrofalowy czujnik ruchu

maksymalny horyzontalny kąt działania czujnika ruchu wynoszący 360°

maksymalny wertykalny kąt działania czujnika ruchu wynoszący 170°

możliwość regulacji czasu świecenia od 10s do 12min

maksymalny zasięg wykrywania ruchu wynoszący 8m, wykrywanie ruchu 0.3...3m/s (1...10km/h), regulacja czułości w zakresie 3...2000lx

DABA LED ECO luminaire is a ceiling light fixture using SMD diodes. It is equipped with a microwave motion detector of 8-metre range of motion detection. The lighting time can be adjusted in the range from 10 seconds to 12 minutes.

the light fixture uses LED SMD 3528 diodes

provided with an MW motion sensor

maximum horizontal adjustment range for the motion sensor: 360°

maximum vertical motion sensor angle: 170°

lighting time adjustable in the range of 10 s to 12 min

maximum motion detection range: 8 m, motion detection 0.3...3 m/s (1...10 km/h), sensitivity adjustment range: 3...2,000 lx

Kanlux

DABA N LED SMD

PLAFONIERA LED ► CEILING-MOUNTED LED LIGHT FITTING

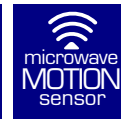

DABA N LED SMD DL-16W



DABA N LED SMD DL-16W | **19062** | 5905339190628 | 16 | 1300 | 4000 | biały | white | mikrofalowy | microwave
DABA N LED SMD DL-22W | **19063** | 5905339190635 | 22 | 1900 | 4000 | biały | white | mikrofalowy | microwave

[V] 220-240 AC	[Hz] 50/60	 120	 ≥20000	 40000	 Ra ≥80	 SMD	 micro wave
IP 66		 -15÷35	 IK 10	 0,75-2,5	 max 8	 H360	 10-10
 5/15/50/2000	 0,5m						



DABA N LED SMD DL-16W

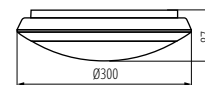

DABA N LED SMD DL-22W

Energooszczędna oprawa Kanlux DABA N daje możliwość zmniejszenia kosztów zużycia energii, dzięki zastosowanym czujnikom ruchu i zmierzchu. To powoduje, że świeci ona tylko wtedy gdy jest to konieczne. Ponadto jej parametry (IP66, IK10) sprawiają, że można ją zamontować praktycznie w każdym miejscu! Funkcja STAND BY DIMMING sprawia, że po zaprogramowanym czasie przy braku ruchu, plafoniera wchodzi w tryb czuwania i zmniejsza strumień świetlny do 20%.

Atest PZH: Numer BK/K/0352/02/2018, ważny do 2023-05-30

Materiał obudowy: tworzywo sztuczne

Materiał klosza: tworzywo sztuczne

Kanlux DABA N is an energy-efficient luminaire allows for decreasing energy consumption costs due to the use of motion detectors and dusk-to-dawn sensors. Therefore, it emits light only when it is necessary. Moreover, its parameters (IP66, IK10) allow for mounting it in almost every place! The ceiling luminaire enters standby mode and decreases the luminous flux to 20% after the pre-set time in the absence of motion using the STAND BY DIMMING function.

Enclosure material: plastic

Lampshade material: plastic

VARSO LED

PLAFONIERA LED ► CEILING-MOUNTED LED LIGHT FITTING



VARSO LED 18W-O; VARSO LED 18W-O-SE



VARSO LED 18W-L; VARSO LED 18W-L-SE



VARSO LED 24W-O; VARSO LED 24W-O-SE



Kanlux VARSO LED to rodzina plafonier hermetycznych ze zintegrowanym źródłem światła LED. Jest to znakomita propozycja zarówno dla inwestycji (spółdzielnie mieszkaniowe, hotele) jak i indywidualnych gospodarstw domowych gdzie potrzebna jest podwyższona odporność na wilgoć (IP54).

Atest PZH: Numer BK/K/0352/01/2018, ważny do 2023-05-30

Materiał obudowy: tworzywo sztuczne

Materiał klosza: tworzywo sztuczne

Kanlux VARSO LED is a family of hermetic ceiling light fixtures with an integrated LED light source. It is a great choice both for investment (housing co-operatives, hotels) and for individual households where increased resistance to humidity (IP54) is needed.

PZH attestation: Number BK/K/0352/01/2018, valid until 2023-05-30

VARSO LED + SE - version with a motion sensor

Enclosure material: plastic

Lampshade material: plastic



VARSO LED 18W-WW-O	26440	5905339264404	18	1620	3000	biały white
VARSO LED 18W-NW-O	26441	5905339264411	18	1700	4000	biały white
VARSO LED 18W-WW-L	26442	5905339264428	18	1620	3000	biały white
VARSO LED 18W-NW-L	26443	5905339264435	18	1700	4000	biały white
VARSO LED 24W-WW-O	26444	5905339264442	24	2160	3000	biały white
VARSO LED 24W-NW-O	26445	5905339264459	24	2280	4000	biały white
VARSO LED 24W-WW-L	26446	5905339264466	24	2160	3000	biały white
VARSO LED 24W-NW-L	26447	5905339264473	24	2280	4000	biały white
VARSO LED 18W-NW-L-SE	26980	5905339269805	18	1700	4000	biały white mikrofalowy microwave
VARSO LED 18W-NW-O-SE	26981	5905339269812	18	1700	4000	biały white mikrofalowy microwave
VARSO LED 24W-NW-L-SE	26983	5905339269836	24	2280	4000	biały white mikrofalowy microwave
VARSO LED 24W-NW-O-SE	26984	5905339269843	24	2280	4000	biały white mikrofalowy microwave

[VI] 220-240 AC	[Hz] 50/60	120	≥20000	20000	≤60 MacAdam	Ra ≥80	SMD	IP 54	🏠
🌡️ -20+35	🔧	📦	📏 0,5-2,5	📏 0,5m	🚫	CE	EAC	Kanlux	🔌

Kanlux

VARSO LED

PLAFONIERA LED ► CEILING-MOUNTED LED LIGHT FITTING



VARSO LED 18W-O; VARSO LED 18W-O-SE



VARSO LED 18W-L; VARSO LED 18W-L-SE



VARSO LED 24W-O; VARSO LED 24W-O-SE



VARSO LED 24W-L; VARSO LED 24W-L-SE

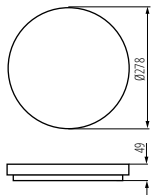

VARSO LED 18W-O; VARSO LED 18W-O-SE

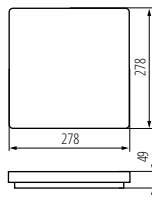

VARSO LED 18W-L; VARSO LED 18W-L-SE

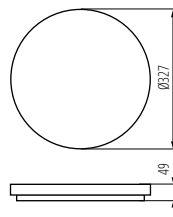

VARSO LED 24W-O; VARSO LED 24W-O-SE

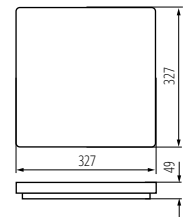

VARSO LED 24W-L; VARSO LED 24W-L-SE



ORTE LED

PLAFONIERA LED ► CEILING-MOUNTED LED LIGHT FITTING

NEW



ORTE LED 18W-NW-O; 18W-O-SE



ORTE LED 18W-O; ORTE LED 18W-O-SE

ORTE LED 24W-O; ORTE LED 24W-O-SE

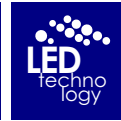

Kanlux ORTE LED to nowa rodzina plafonier gdzie szczególną uwagę zwróciliśmy na design i łatwość instalacji. Dla dodatkowej wygody proponujemy Wam również wersje z czujnikiem ruchu.

Materiał obudowy: tworzywo sztuczne
Materiał klosza: tworzywo sztuczne



Kanlux ORTE LED is a new family of wall and ceiling fixtures in which particular attention has been paid to design and ease of installation. For added convenience, you can also choose from various motion detector versions.

Enclosure material: plastic
Lampshade material: plastic



ORTE LED 18W-NW-O	29160	5905339291608	18	1600	4000	biały white	
ORTE LED 24W-NW-O	29161	5905339291615	24	2200	4000	biały white	
ORTE LED 18W-NW-O-SE	29162	5905339291622	18	1600	4000	biały white	mikrofalowy microwave
ORTE LED 24W-NW-O-SE	29163	5905339291639	24	2200	4000	biały white	mikrofalowy microwave

[V]	[Hz]	[°]	[lm]	[h]	[Ra]	[SMD]	[IP]
220-240 AC	50/60	120	≥20000	20000	≤60 MacAdam	≥80	54
[°C]	[mm²]	[m]	[m]	[m]	[m]	[m]	[m]
-20+35	0,75+2,5	0,5m					

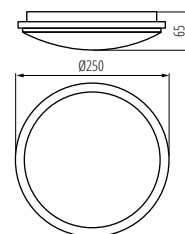

ORTE LED 18W-O; ORTE LED 18W-O-SE

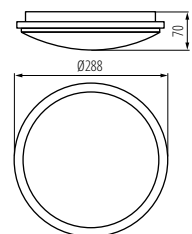

ORTE LED 24W-O; ORTE LED 24W-O-SE

Kanlux

FOGLER LED

PLAFONIERA LED ► CEILING-MOUNTED LED LIGHT FITTING



FOGLER LED 14W-NW



FOGLER LED 14W-NW | 18121 | 5905339181213 | 14 | 800 | 4000 | biały | white | PIR

[V]	[Hz]	[lm]	[h]	[Ra]	[SMD]	[IP]	[°C]
220-240 AC	50/60	≥15000	20000	≥80	SMD	IP 20	5+25
[mm]	[m]	[s]	[s]	[s]	[lx]	[m]	
0,5-2,5	max 6	360	10-5	PIR	5-2000	0,5m	

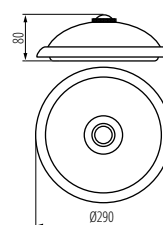

FOGLER LED 14W-NW

Kanlux

SANSO LED

PLAFONIERA LED ► CEILING-MOUNTED LED LIGHT FITTING



SANSO LED 15W-NW-SE



SANSO LED 15W-NW-SE | 26520 | 5905339265203 | 15 | 1250 | 4000 | biały | white | PIR

[V]	[Hz]	[°]	[lm]	[h]	[Ra]	[SMD]	[IP]	[°C]
220-240 AC	50/60	120	≥15000	15000	≥80	SMD	IP 44	-20+35
[mm]	[m]	[s]	[s]	[s]	[lx]	[m]		
0,5-1,5	max 6	H160	5-5	PIR	8-2000	0,5m		



Plafoniera Kanlux SANSO LED z wbudowanym czujnikiem ruchu PIR pozwala na dostosowanie jej do własnych potrzeb. Charakteryzuje się ona także podwyższoną szczelnością (IP 44), dzięki czemu jej wnętrze chronione jest przed kurzem i pyłem.

Materiał obudowy: PC
Materiał klosza: PC

Kanlux SANSO LED ceiling luminaire with a built-in motion detector PIR allows for its customisation depending on your needs. It is also characterised by increased tightness (IP 44) so its inside is protected against dust and dirt.

Enclosure material: PC
Lampshade material: PC

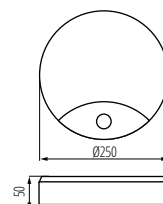

SANSO LED 15W-NW-SE

BIGGE LED

PLAFONIERA LED ► CEILING-MOUNTED LED LIGHT FITTING

NEW



BIGGE LED 42W-O



BIGGE LED 42W-O



BIGGE LED 42W-L



Kanlux BIGGE LED to seria plafonier o dużych mocach i rozmiarach. Świetnie sprawdzą się jako oświetlenie ciągów komunikacyjnych, klatek schodowych i korytarzy, a także dużych, otwartych przestrzeni.

Materiał obudowy: stal

Materiał klosza: tworzywo sztuczne



Kanlux BIGGE LED is a series of large, high-power and wall and ceiling fixtures. They are perfect for illuminating communication routes, staircases and corridors, as well as large, open spaces.

Enclosure material: steel

Lampshade material: plastic

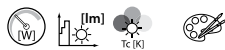

BIGGE LED 42W-NW-O	28721	5905339287212	42	2700	4000	biały white
BIGGE LED 42W-WW-L	28722	5905339287229	42	2700	3000	biały white
BIGGE LED 42W-WW-O	28720	5905339287205	42	2700	3000	biały white
BIGGE LED 42W-NW-L	28723	5905339287236	42	2700	4000	biały white

[V] 220-240 AC	[Hz] 50/60	[lm] 120	[h] ≥20000	[h] 25000	[lm] ≤ 6x MacAdam	Ra ≥80	SMD	CE	ERC	IP 20	1,5+2,5	0,5m	CE	ERC	Kanlux
-------------------	---------------	-------------	---------------	--------------	----------------------	-----------	-----	----	-----	----------	---------	------	----	-----	--------

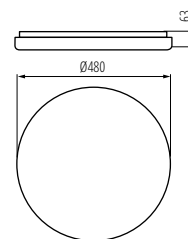

BIGGE LED 42W-O

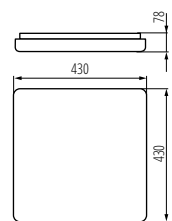

BIGGE LED 42W-L

Kanlux TYBIA LED

PLAFONIERA LED ► CEILING-MOUNTED LED LIGHT FITTING



TYBIA LED 38W-NW; NW-SE



Kanlux TYBIA LED to oprawa oświetlenia ogólnego, w której zastosowano diody SMD. Montaż oprawy TYBIA LED w korytarzach, klatkach schodowych, pokojach socjalnych czy gospodarczych, gwarantuje znaczne oszczędności nie tylko związane z poborem energii ale także jej długoterminową, bezobsługową eksploatacją.

Materiał obudowy: stop aluminium
Materiał klosza: PMMA

Kanlux TYBIA LED is a general lighting luminaire using SMD diodes. When mounted in corridors, staircases, social or utility rooms, TYBIA LED allows for significant savings related to both reduced energy consumption and the long-term maintenance-free operation.

Enclosure material: aluminum alloy
Lampshade material: PMMA



TYBIA LED 38W-NW	24640	5905339246400	38	3500	4000	szary / biały grey / white
TYBIA LED 38W-NW-SE	24641	5905339246417	38	3500	4000	szary / biały grey / white mikrofalowy microwave

[V]	[Hz]	[°]	[h]	[lm]	[K]	[Ra]	[SMD]	[Sensor]
220-240 AC	50/60	110	≥20000	30000	≤6xMaxdam	≥80	SMD	SENSOR
IP 20	House icon	5+25	Mounting icon	1-2,5	0,5m	CE	ERAC	Kanlux logo

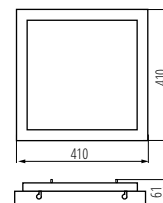

TYBIA LED 38W; 38W SE

Kanlux PORTOS LED

PLAFONIERA LED ► CEILING-MOUNTED LED LIGHT FITTING



PORTOS LED



Kanlux PORTOS to wytrzymała i odporna na działanie czynników zewnętrznych oprawa LED. Może być stosowana zarówno w pomieszczeniach, jak i na zewnątrz, bez obaw, że wilgoć i pył zmniejszą jej wydajność pracy.

Materiał obudowy: tworzywo sztuczne
Materiał klosza: tworzywo sztuczne

The Kanlux PORTOS is a LED fixture which is durable and resistant to exposure to external factors. It can be used both indoors and outdoors, without the risk of moisture and dust reducing its efficiency.

Enclosure material: plastic
Lampshade material: plastic

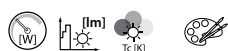

PORTOS LED	29070	5905339290700	5	500	4000	biały white
------------	--------------	---------------	---	-----	------	---------------

[V]	[Hz]	[°]	[h]	[lm]	[K]	[Ra]	[SMD]	[Sensor]
220-240 AC	50/60	120	≥10000	30000	4000	≤6xMaxdam	≥80	SMD
IP 54	House icon	-10+35	Mounting icon	0,5+1,5	0,5m	CE	ERAC	Kanlux logo

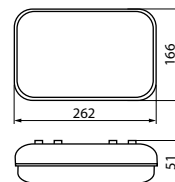

PORTOS LED

Kanlux

FOGLER DL

PLAFONIERA Z WYMIENNYM ŹRÓDŁEM ŚWIATŁA ► CEILING-MOUNTED LIGHT FITTING WITH REPLACEABLE LIGHT SOURCE



FOGLER DL-2400



FOGLER DL-2400 | 18120 | 5905339181206 | 2 x max 40 | GLS/CFL/LED | E27 | biały | white

[V] 220-240 AC	[Hz] 50/60	⊕	IP 20	🏠	🌡️ 5+25	🔧	📦	📏 1-2,5
📶 max 8	📶 H360/ V120	🕒 12-5	📷 PIR	📏 3-2000	📏 0,5m	💡	CE	EAC

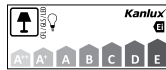

Plafoniera Kanlux FOGLER DL z wymiennym źródłem światła doskonale sprawdzi się na klatkach schodowych, piwnicach, strycharzach i innych tego typu pomieszczeniach. Wbudowany czujnik z maksymalnym kątem (360°) wykrywania ruchu, gwarantuje, że oprawa włączy się dokładnie wtedy, kiedy potrzebujemy światła.

wyposażona w czujnik ruchu
maksymalny horyzontalny kąt działania czujnika ruchu wynoszący 360°
maksymalny wertykalny kąt działania czujnika ruchu wynoszący 120°
możliwość regulacji czasu świecenia od 5s do 5min
maksymalny zasięg wykrywania ruchu wynoszący 8m
wykrywanie ruchu 0.3...3m/s (1...10km/h)
Materiał obudowy: żelazo
Materiał klosza: szkło

Kanlux FOGLER DL ceiling light fixture with a replaceable light source is a great choice for staircases, basements, attics and similar spaces. The built-in detector with the maximum angle (360°) of motion detection guarantees that the light turns on exactly when we need it.

provided with a motion sensor
maximum horizontal adjustment range for the motion sensor: 360°
maximum vertical motion sensor angle: 120°
lighting time adjustable in the range of 5 s to 5 min
maximum motion detection range: 8 m
motion detection 0.3...3 m/s (1...10 km/h)
Enclosure material: iron
Lampshade material: glass

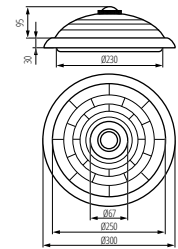

FOGLER DL-2400

Kanlux

JURBA DL

PLAFONIERA Z WYMIENNYM ŹRÓDŁEM ŚWIATŁA ► CEILING-MOUNTED LIGHT FITTING WITH REPLACEABLE LIGHT SOURCE



JURBA DL-2180



JURBA DL-2180 | 08980 | 5905339089809 | 2 x max 18 | CFL/LED | E27 | nikiel satynowy | nickel satin
JURBA DL-218L | 08981 | 5905339089816 | 2 x max 18 | CFL/LED | E27 | nikiel satynowy | nickel satin

[V] 220-240 AC	[Hz] 50/60	□	IP 44	🏠	🌡️ -10+35	🔧	IK 10
📦	📏 1-2,5	📏 0,1m	💡	CE	EAC	📏	Kanlux G



JURBA DL-218L



Plafoniera hermetyczna Kanlux JURBA to doskonała jakość wykonania. Oprawę można montować zarówno na ścianie jak i na suficie, wewnątrz i na zewnątrz budynków. Oprawy Kanlux JURBA posiadają podwyższony stopień pyłoszczelności jak i wodoszczelności - IP44.

Materiał obudowy: stal
Materiał klosza: PC

Kanlux JURBA is a hermetic ceiling light fixture of excellent workmanship. The fixture can be mounted both on ceilings and on walls, indoors and outdoors. Kanlux JURBA luminaires have increased resistance to dust and water - IP44.

Enclosure material: steel
Lampshade material: PC

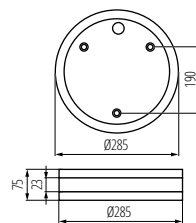

JURBA DL-2180

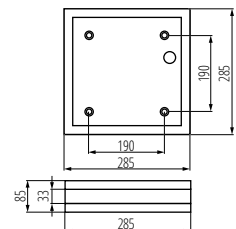

JURBA DL-218L

Kanlux

KIRA DL

PLAFONIERA Z WYMIENNYM ŹRÓDŁEM ŚWIATŁA ► CEILING-MOUNTED LIGHT FITTING WITH REPLACEABLE LIGHT SOURCE



KIRA DL-75B



KIRA DL-75B | **07900** | 5905339079008 max 75 GLS/CFL/LED E27 biały | white

[V] 220-240 AC	[Hz] 50/60		IP 44		
IK 10	 0,5m				

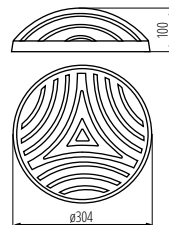

KIRA DL-75B



Plafoniera Kanlux KIRA posiada klosz wykonany z poliwęglanu, co czyni ją niezwykle odporną na uderzenia (IK10). Stopień IP44 informuje że można ją zamontować w pomieszczeniach, w których panuje wilgoć i zapylenie.

wysoka odporność na promieniowanie UV (PIKTO)
wysoka odporność na uderzenia

Kanlux KIRA ceiling light fixture has a shade made of polycarbonate, which makes it extremely impact resistant (IK10). IP44 class informs that it can be mounted in rooms in which there is moisture and pollution.

high UV resistance (PICTO)
high impact resistance

Kanlux

MARC DL

PLAFONIERA Z WYMIENNYM ŹRÓDŁEM ŚWIATŁA ► CEILING-MOUNTED LIGHT FITTING WITH REPLACEABLE LIGHT SOURCE



MARC DL-60



MARC DL-60 | **07015** | 5905339070159 max 60 GLS/CFL/LED E27 biały | white

[V] 220-240 AC	[Hz] 50/60		IP 54			IK 10
	 1-1,5	 0,5m				

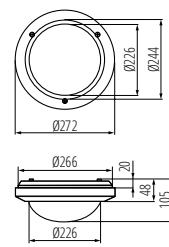

MARC DL-60



Plafoniera Kanlux MARC DL to prosty design, za którym kryje się jednak duża wytrzymałość oprawy na uderzenia (IK10). Wysoka odporność na zapylenie, wilgoć (IP54) i promieniowanie UV to dodatkowe atuty tej oprawy.

wysoka odporność na promieniowanie UV (PIKTO)
wysoka odporność na uderzenia

Kanlux MARC DL ceiling light fixture combines simple design and high impact resistance of the luminaire (IK10). High resistance to dust, moisture (IP54) and UV radiation are other assets of the luminaire.

high UV resistance (PICTO)
high impact resistance

PIRES DL

PLAFONIERA Z WYMIENNYM ŹRÓDŁEM ŚWIATŁA

► CEILING-MOUNTED LIGHT FITTING WITH REPLACEABLE LIGHT SOURCE



PIRES DL-600



PIRES DL-600 NS



PIRES ECO DL-250



PIRES ECO DL-250 NS



PIRES DL-600	08810	5905339088109	max 60	GLS/CFL/LED	E27	biały white	mikrofalowy microwave
PIRES DL-600 NS	08811	5905339088116	max 60	GLS/CFL/LED	E27	biały white	
PIRES ECO DL-250	19000	5905339190000	max 25	CFL/LED	E27	biały white	mikrofalowy microwave
PIRES ECO DL-250 NS	19001	5905339190017	max 25	CFL/LED	E27	biały white	

[V] 220-240 AC	[Hz] 50/60	IP 44	°C 5÷35

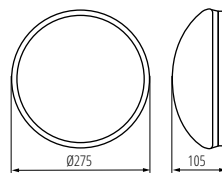

PIRES DL-600

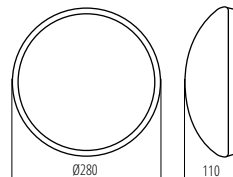

PIRES DL-600 NS

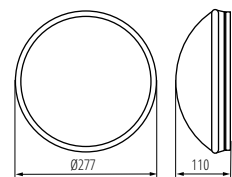

PIRES ECO DL-250; PIRES ECO DL-250 NS



Kanlux PIRES to plafoniera o minimalistycznym wyglądzie, którą dzięki stopniowi szczelności IP44 zastosujemy również na zewnątrz. Dla większego komfortu proponujemy Wam również wersje wyposażone w mikrofalowy czujnik ruchu (kod 19000 i 8810), którego zasięg wynosi 9 metrów.

wyposażona w mikrofalowy czujnik ruchu
maksymalny horyzontalny kąt działania czujnika ruchu wynoszący 360°
maksymalny wertykalny kąt działania czujnika ruchu wynoszący 140°
możliwość regulacji czasu świecenia od 8s do 12min
maksymalny zasięg wykrywania ruchu wynoszący 9m
wykrywanie ruchu 0.3...3m/s (1...10km/h), regulacja czułości w zakresie 2...2000lx
Materiał obudowy: stal

Kanlux PIRES is a ceiling light fixture with minimalistic appearance which can be used outside too thanks to IP44 degree of tightness. To increase comfort, we also propose versions equipped with a microwave motion detector (code 19000 and 8810) the range of which comes to 9 metres).

provided with a MW motion sensor
maximum horizontal adjustment range for the motion sensor: 360°
maximum vertical motion sensor angle: 140°
lighting time adjustable in the range of 8 s to 12 min
maximum motion detection range: 9 m
motion detection 0.3...3 m/s (1...10 km/h), sensitivity adjustment range: 2...2,000 lx
Enclosure material: steel

Kanlux TYBIA

PLAFONIERA Z WYMIENNYM ŹRÓDŁEM ŚWIATŁA ► CEILING-MOUNTED LIGHT FITTING
WITH REPLACEABLE LIGHT SOURCE



TYBIA DL-224L



TYBIA DL-224L | 19010 | 5905339190109 | 2 x 24 | 2G11 | szary / biały | grey / white

[V] 220-240 AC	[Hz] 50/60	PL-L		IP 20	5+25	
		EVG BALLAST	0,5m	CE	EAC	

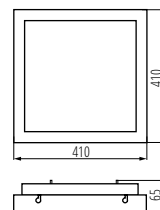

TYBIA DL-224L



Kanlux TYBIA to oprawa oświetlenia ogólnego, w której stosuje się świetlówki wtykowe typu PL-L. Dzięki konstrukcji tej plafonierzy uzyskujemy nie tylko estetyczny efekt rozświetlenia sufitu wokół oprawy, ale również poprawia się równomierność rozłożenia światła, czyli komfort pracy w całym oświetlanym pomieszczeniu. Znakomicie nadaje się do oświetlania pomieszczeń w których pożądane jest miękkie rozproszone światło.

możliwość montażu na linkach

Materiał obudowy: stal

Materiał klosza: PMMA

Kanlux TYBIA is a luminaire for general lighting using PL-L plug-in fluorescent bulbs. Due to its construction, we add an aesthetic effect of illumination of the ceiling around the luminaire and improve even light distribution, that is comfort of work in the whole illuminated room. A great choice for lighting rooms in which we need soft diffused light.

optional installation as a cord-hanging light fixture

Enclosure material: steel

Lampshade material: PMMA

Kanlux INES

OPRAWA KANAŁOWA ► BULKHEAD FIXTURE



INES 7061N



INES 7061N | 70525 | 5905339705259 | max 100 | GLS/CFL/LED | E27 | biały | white

[V] 220-240 AC	[Hz] 50/60	IP 43			
		EVG BALLAST	0,5m		CE



Kanlux INES to wytrzymała oprawa hermetyczna (IK08), z wymiennym źródłem światła, która posiada dodatkową ochronę w postaci metalowej siatki.

Materiał obudowy: tworzywo sztuczne

Materiał klosza: szkło

Kanlux INES is a durable hermetic luminaire (IK08) with a replaceable light source and additional protection - a metal mesh.

Enclosure material: plastic

Lampshade material: glass

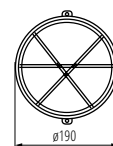
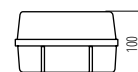

INES 7061N

Kanlux MILE

OPRAWA KANAŁOWA ► BULKHEAD FIXTURE



MILE 7041S

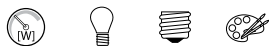

MILE 7041S | **14613** | 5907540956888 | max 60 | GLS/CFL/LED | E27 | biały | white

[V] 220-240 AC	[Hz] 50/60	□ IP 54	🏠 E27	
🔧	📏 0,5m	💡	CE	

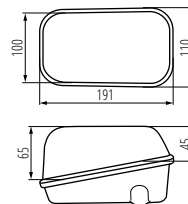

MILE 7041S



Kanlux MILE to klasyczna oprawa kanałowa, która przeznaczona jest do oświetlenia pomieszczeń technicznych, garaży, piwnic czy klatek schodowych.

Materiał klosza: PC

Kanlux MILE is a classic channel luminaire designed for lighting of technical rooms, garages, basements or staircases.

Lampshade material: PC

Kanlux MILO

OPRAWA KANAŁOWA ► BULKHEAD FIXTURE



MILO 7040T



MILO 7040T | **70522** | 5905339705228 | max 60 | GLS/CFL/LED | E27 | szary | grey
MILO 7040T/P | **70523** | 5905339705235 | max 60 | GLS/CFL/LED | E27 | szary | grey

[V] 220-240 AC	[Hz] 50/60	□ IP 54	🏠 E27	🔧	IK 06	
🔧	📏 1-1,5	📏 0,5m	💡	CE	ERAC	



MILO 7040T/P



Kanlux MILO to klasyczna oprawa kanałowa którą zwykle stosuje się w pomieszczeniach technicznych, garażach, piwnicach, klatkach schodowych, korytarzach itp. Oprawa ta posiada metalową (7040T) lub plastikową (7040T/P) siatkę ochronną, która dodatkowo chroni klosz oprawy przed uszkodzeniami mechanicznymi.

Materiał obudowy: tworzywo sztuczne

Materiał klosza: szkło

Kanlux MILO is a classic channel luminaire used usually in technical rooms, garages, basements, staircases, corridors, etc. The luminaire has a metal (7040T) or plastic (7040T/P) protective mesh which protects the shade from mechanical damage.

Enclosure material: plastic

Lampshade material: glass

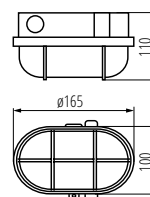

MILO 7040T

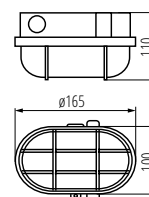

MILO 7040T/P

Kanlux HERMI

OPRAWA KANAŁOWA ► BULKHEAD FIXTURE



HERMI 7063NB



HERMI 7063NB | 70524 | 5905339705242 | max 100 | GLS/CFL/LED | E27 | szary | grey

[V] 220-240 AC	[Hz] 50/60	[mm] 1-1,5	IP 54	CE	EAC	Kanlux

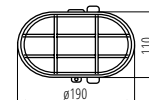
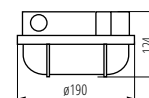

HERMI 7063NB



Kanlux HERMI to oprawa kanałowa z wysokim stopniem szczelności (IP54), który świadczy o jej ochronie przed zapyleniem i bryzgami wody. Oprawa ta posiada dodatkowo metalową siatkę, która chroni klosz oprawy przed uszkodzeniami mechanicznymi.

Materiał obudowy: tworzywo sztuczne

Materiał klosza: szkło

Kanlux HERMI is a channel luminaire with a high tightness rating (IP54), which means high protection against dust and water splashes. The luminaire also has a metal mesh which protects the shade from mechanical damage.

Enclosure material: plastic

Lampshade material: glass



Kanlux TURK

PLAFONIERA Z WYMIENNYM ŹRÓDŁEM ŚWIATŁA ► CEILING-MOUNTED LIGHT FITTING WITH REPLACEABLE LIGHT SOURCE



TURK DL-60



TURK DL-60 | 07025 | 5905339070258 | max 60 | E27 | biały | white

[V] 220-240 AC	[Hz] 50/60	□	IP 54	🏠	🔧	
💡	🔌 1-2,5	📏 0,5m	💡	CE	EMC	

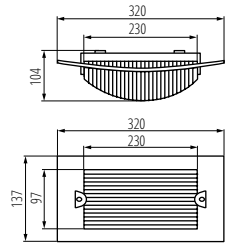

TURK DL-60

Kanlux SHARK N

PLAFONIERA Z WYMIENNYM ŹRÓDŁEM ŚWIATŁA ► CEILING-MOUNTED LIGHT FITTING WITH REPLACEABLE LIGHT SOURCE



SHARK N EL-60



SHARK N EL-60 | 29060 | 5905339290601 | max 40 | E27 | GLS/CFL/LED | szary | grey

[V] 220-240 AC	[Hz] 50/60	⊕	IP 44	🏠	🔧	
💡	🔌 1-1,5	📏 0,5m	💡	CE	EMC	

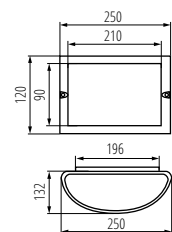

SHARK N EL-60



Kanlux TURK to bardzo wytrzymała na uderzenia plafoniera (IK10). Dodatkowa wysoka odporność na promieniowanie UV sprawia, że doskonale sprawdzi się w warunkach użytkowania zewnętrznego, np. na elewacji budynku, tarasie czy balkonie.

wysoka odporność na promieniowanie UV (PIKTO)

wysoka odporność na uderzenia

Kanlux TURK is an extremely impact resistant ceiling light fixture (IK10). Additional high resistance to UV radiation makes it perfect for outdoor use, e.g. on building façade, terrace or balcony.

high UV resistance (PIKTO)

high impact resistance



Kanlux SHARK to tradycyjna oprawa hermetyczna dla użytkowników, którzy cenią sobie wymienne źródło światła w tego typu oświetleniu. Charakteryzuje się wysoką odpornością na promieniowanie UV i uderzenia.

Materiał obudowy: stop aluminium

Materiał klosza: PC

Kanlux SHARK is a traditional hermetic fixture for those who appreciate a replaceable light source in this type of light fixture. It is characterised by its high resistance to UV radiation and impact.

Enclosure material: aluminum alloy

Lampshade material: PC

Kanlux

SANGA DL

PLAFONIERA Z WYMIENNYM ŹRÓDŁEM ŚWIATŁA ► CEILING-MOUNTED LIGHT FITTING WITH REPLACEABLE LIGHT SOURCE



SANGA DL-100



SANGA DL-100 | 08050 | 5905339080509 | max 100 | GLS/CFL/LED | E27 | biały | white

[V] 220-240 AC	[Hz] 50/60	IP 44							
	 1-1,5	 0,5m							

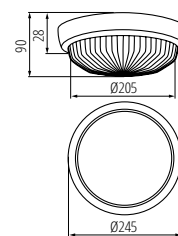

SANGA DL-100



Plafoniera Kanlux SANGA to ekonomiczne rozwiązanie dla klatek schodowych, piwnic, strychów, garaży, lecz także dla tarasów i balkonów.

Materiał obudowy: tworzywo sztuczne
Materiał klosza: szkło

Kanlux SANGA ceiling fixture is an economical solution for staircases, basements, attics, garages, and also for terraces and balconies.

Enclosure material: plastic
Lampshade material: glass

Kanlux

TUNA

PLAFONIERA Z WYMIENNYM ŹRÓDŁEM ŚWIATŁA ► CEILING-MOUNTED LIGHT FITTING WITH REPLACEABLE LIGHT SOURCE



TUNA S1101-W



TUNA S1101-W | 04260 | 5905339042606 | max 100 | GLS/CFL/LED | E27 | biały | white
TUNA MINI N | 08091 | 5905339080912 | max 100 | GLS/CFL/LED | E27 | biały | white

[V] 220-240 AC	[Hz] 50/60	IP 44							
	 1-1,5	 0,5m							



TUNA MINI N



Plafoniera kanlux TUNA to rozwiązanie dla klatek schodowych, piwnic, strychów i innych tego typu pomieszczeń. Odpowiedni stopień ochrony przed zapyleniem i wilgocią umożliwia stosowanie oprawy zarówno wewnątrz jak i na zewnątrz budynków.

Materiał obudowy: tworzywo sztuczne
Materiał klosza: szkło

Kanlux TUNA ceiling light fixture is a good choice for staircases, basements, attics and other such rooms. Proper level of protection against dust and moisture allows for its use both indoors and outdoors.

Enclosure material: plastic
Lampshade material: glass

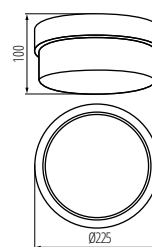

TUNA S1101

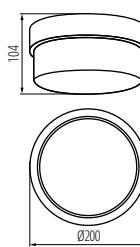

TUNA MINI

MATEO

OPRAWA TYPU DOWNLIGHT ► DOWNLIGHT FITTING



MATEO DLP-150-GR



MATEO DLP-250-GR



MATEO DLP-350-GR

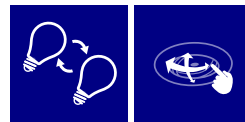

Kanlux MATEO to elegancka oprawa sufitowa posiadająca efektowny odbłyśnik. Połączenie srebrnego i czarnego koloru dodaje oprawom elegancji i wyrazistego oblicza. Dzięki regulacji kątowej możemy skierować światło na wybrany przez nas punkt.



Materiał obudowy: stal

Kanlux MATEO is an elegant ceiling luminaire with a spectacular reflector. The combination of silver and black colour makes the luminaires smart and distinct. Owing to angular adjustment, we can direct the light towards the selected point.



Enclosure material: steel

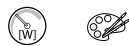

MATEO DLP-150-GR	04960	5905339049605	max 50	szary grey
MATEO DLP-250-GR	04961	5905339049612	2 x max 50	szary grey
MATEO DLP-350-GR	04962	5905339049629	3 x max 50	szary grey

IvI 12 AC; 12 DC	G53	III	IP 20	5+25
A+ A A B C D E				

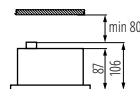
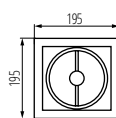

MATEO DLP-150

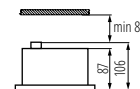
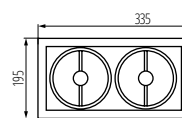

MATEO DLP-250

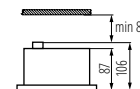
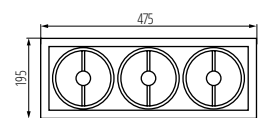

MATEO DLP-350

Kanlux ARTO

OPRAWA TYPU DOWNLIGHT ► DOWNLIGHT FITTING



ARTO 10-SR



ARTO 2L-SR



ARTO 3L-SR



ARTO 1L-W



ARTO 1L-W	26610	5905339266101	max 35	biały white
ARTO 10-SR	26613	5905339266132	max 35	srebrny silver
ARTO 2L-SR	26614	5905339266149	2 x max 35	srebrny silver
ARTO 3L-SR	26616	5905339266163	3 x max 35	srebrny silver

[V] 12 AC; 12 DC	AR-111	G53	IP 20	
5-25		15/15	1m	
A+ A- A B C D E				

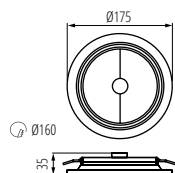

ARTO 10

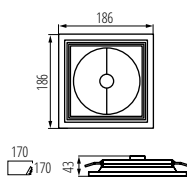

ARTO 1L

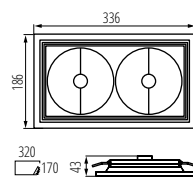

ARTO 2L

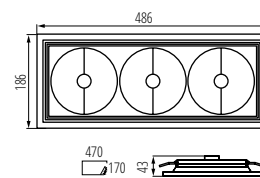

ARTO 3L

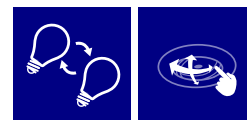

Oprawy Kanlux ARTO przeznaczone są dla źródeł światła typu AR111. To oprawa dyskretna o prostej stylistyce, z możliwością regulacji kąta padania światła.

Materiał obudowy: stal

Kanlux ARTO luminaires are designed for AR111 light sources. The luminaire is discrete, has a simple design and allows for adjusting the angle of light incidence.

Enclosure material: steel

Kanlux OZON

OPRAWA TYPU DOWNLIGHT ► DOWNLIGHT FITTING



OZON DLBS-1AV/27-W



OZON DLBS-1AV/27-W | 00905 | 590533909050 max 60 biały | white

[V] 220-240 AC	[Hz] 50/60	E27	⊕	IP 20	House icon	°C 5÷25	Light bulb icon
Light bulb icon	1-1,5	125-135	0,5m	CE	ERL	Kanlux G A A A B C D E	



Kanlux OZON to downlight do wnętrza, w którym mocowane jest źródło o trzonku E27. Jest to oprawa podtynkowa i możemy ją zastosować w pomieszczeniach mieszkalnych jak np. salon, przedpokój, sypialnia.

Materiał obudowy: stal

Materiał odbłyśnika: stop aluminium

Kanlux OZON is an indoor downlight with the light source mounted to an E27 screw. It is a recessed luminaire that can be used in living spaces such as dining rooms, hallways, bedrooms.

Enclosure material: steel

Reflector material: aluminum alloy

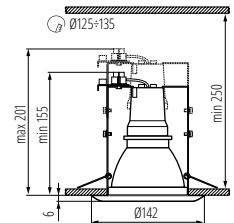

OZON DLBS-1AV/27-W

Kanlux RALF

OPRAWA TYPU DOWNLIGHT ► DOWNLIGHT FITTING



RALF DL-220-W



RALF DL-220-W | 04820 | 5905339048202 2 x max 20 biały | white

[V] 220-240 AC	[Hz] 50/60	E27	⊕	IP 20	House icon	°C 5÷25	Light bulb icon
Light bulb icon	1-2,5	Ø210	0,5m	CE	ERL	Kanlux G A A A B C D E	



Oprawa typu downlight Kanlux RALF przeznaczona jest do wbudowania w sufit podwieszany. Z powodzeniem może być zastosowana w pomieszczeniach zarówno mieszkalnych jak i użyteczności publicznej.

Materiał obudowy: stal

Materiał klosza: szkło

Materiał odbłyśnika: stop aluminium

Kanlux RALF downlight luminaire is designed for mounting in suspended ceilings. It is perfect for both residential and public spaces.

Enclosure material: steel

Lampshade material: glass

Reflector material: aluminum alloy

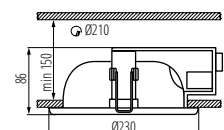

RALF DL-220-W

Kanlux TIBERI

OPRAWA TYPU DOWNLIGHT ► DOWNLIGHT FITTING



TIBERI LED SMD 24W-0



TIBERI LED SMD 36W-0



Okragłe oprawy Kanlux TIBERI wykorzystują diody LED SMD do emitowania intensywnego światła, dzięki temu świetnie sprawdzą się w wyższych pomieszczeniach biurowych czy przemysłowych. Podwyższona szczelność IP44, chroni je przed kurzem, pyłem i wilgocią.

Materiał obudowy: stop aluminium

Materiał klosza: PS

Round Kanlux TIBERI luminaires use SMD LEDs to emit intense light. Owing to this, they work well in high office or industrial rooms. Increased tightness of IP44 protects them from dust, dirt and moisture.

Enclosure material: aluminum alloy

Lampshade material: PS

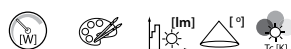

TIBERI LED SMD 24W-0	25510	5905339255105	24	biały white	2400	100	4000
TIBERI LED SMD 36W-0	25511	5905339255112	36	biały white	3900	100	4000

[V] 220-240 AC	[Hz] 50/60	≥15000	20000	ellipse ≤ 6x MacAdam	Ra ≥80	SMD	CE	ERAC
IP 44/20	5±25	0,5m	0,5m	0,5m	0,5m	0,5m	0,5m	0,5m

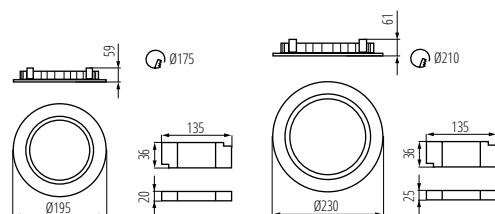

TIBERI LED SMD 24W

TIBERI LED SMD 36W

Kanlux IVIAN

OPRAWA PUNKTOWA LED IP44 ► LED SPOTLIGHT FITTING, IP44



IVIAN LED 4,5W W-WW



IVIAN LED 4,5W SN-WW



Kanlux IVIAN LED to rodzina opraw typu downlight. Charakteryzuje się podwyższonym stopniem szczelności – IP44, co pozwala na zastosowanie jej w łazienkach i pomieszczeniach o zwiększonej wilgotności. Źródło światła stanowią diody LED SMD, a obudowa wykonana jest z tworzywa sztucznego.

Materiał obudowy: tworzywo sztuczne

Materiał klosza: tworzywo sztuczne

Kanlux IVIAN LED is a family of downlight type holders. It is characterized by an increased degree of tightness - IP44, which allows using it in bathrooms and rooms with increased humidity. LED SMD diodes are the light source and the casing is made of plastic.

Enclosure material: plastic

Lampshade material: plastic

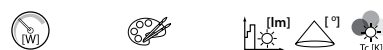

MAN LED 4,5W W-WW	25780	5905339257802	4,5	biały white	340	100	3000
MAN LED 4,5W SN-WW	25781	5905339257819	4,5	nikiel satynowy nickel satin	340	100	3000
MAN LED 4,5W W-NW	25782	5905339257826	4,5	biały white	370	100	4000
MAN LED 4,5W SN-NW	25783	5905339257833	4,5	nikiel satynowy nickel satin	370	100	4000

[V] 220-240 AC	[Hz] 50/60	≥25000	15000	ellipse ≤ 6x MacAdam	Ra ≥80	SMD	CE	ERAC	IP 44
0,65	5±25	0,5m	0,5m	0,5m	0,5m	0,5m	0,5m	0,5m	0,5m

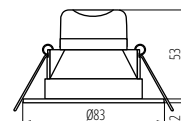

IVIAN LED 4,5W

Kanlux LITEN

OPRAWA TYPU DOWNLIGHT ► DOWNLIGHT FITTING



LITEN LED 6W-NW



Oprawy downlight Kanlux LITEN ze zintegrowanym źródłem światła LED, przeznaczone są do zamontowania w suficie podwieszanym. Wszystkie oprawy sufitowe Kanlux LITEN posiadają wbudowany zasilacz umożliwiający podłączenie opraw do instalacji 230V AC.

Materiał obudowy: tworzywo sztuczne
Materiał klosza: tworzywo sztuczne

Kanlux LITEN downlights with integrated LED light source are designed for mounting in suspended ceilings. All Kanlux LITEN ceiling luminaires have a built-in power supply enabling connection of the luminaires to an AC grid.

Enclosure material: plastic
Lampshade material: plastic

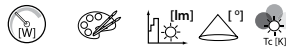

LITEN LED 6W-WW	25560	5905339255600	6	biały white	390	110	3000
LITEN LED 6W-NW	25561	5905339255617	6	biały white	390	110	4000
LITEN LED 8W-WW	25562	5905339255624	8	biały white	550	110	3000
LITEN LED 8W-NW	25563	5905339255631	8	biały white	550	110	4000

[V]	[Hz]	[h]	[h]	[lm]	[°]	[K]	[m]	[m]	[m]	[m]	[m]
220-240 AC	50/60	≥25000	20000	≤6 MacAdam	≥80	SMD	CE	ERAC	IP 40/20	5+25	0,5m

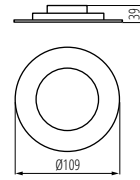

LITEN LED 6W

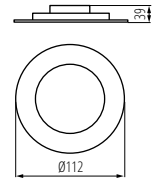

LITEN LED 8W

Kanlux ARME LED

OPRAWA TYPU DOWNLIGHT ► DOWNLIGHT FITTING



ARME LED L 5W-WW

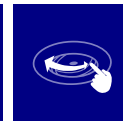

Kanlux ARME LED to niewielkich rozmiarów oprawa ze zintegrowanym źródłem światła LED. Jest prosta w formie, wyposażona w zintegrowany zasilacz. Kanlux ARME LED posiada możliwość regulacji kierunku świecenia w zakresie 35°. Sprawdza się pojedynczo jako doświetlenie lub w grupie jako oświetlenie większych powierzchni.

Materiał obudowy: tworzywo sztuczne
Materiał klosza: tworzywo sztuczne

The Kanlux ARME LED is a small fixture with an integrated LED light source. It is simple in form, and equipped with a integrated power supply. The Kanlux ARME LED has the facility to adjust the direction of illumination within the range of 35°. It can be used individually as an additional illumination or in a group as an illumination of larger areas.

Enclosure material: plastic
Lampshade material: plastic

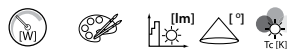

ARME LED L 5W-WW	28250	5905339282507	5	biały white	370	40	3000
ARME LED O 5W-WW	28251	5905339282514	5	biały white	370	40	3000

[V]	[Hz]	[h]	[h]	[lm]	[°]	[K]	[m]	[m]	[m]	[m]	[m]
220-240 AC	50/60	≥15000	20000	≤6 MacAdam	≥80	SMD	CE	ERAC	IP 20	5+25	0,5m

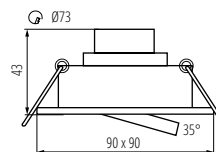

ARME LED L

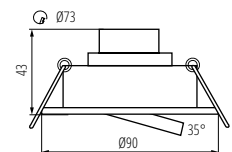

ARME LED O

AREL LED

OPRAWA TYPU DOWNLIGHT ► DOWNLIGHT FITTING

NEW



AREL LED DO 20W



AREL LED DL 10W



IP 65/20

ultra SLIM panel

HIGH quality

Kanlux AREL LED to nowa rodzina downlightów, które nie posiadają ramki. Wysoka klasa szczelności IP65/20 oraz wyjątkowy, prosty, a zarazem zaskakujący design sprawia, że Kanlux AREL LED wpasuje się w każde wnętrze. Dzięki unikatowej konstrukcji, panel ma grubość zaledwie 9 mm – to najcieńszy panel dostępny na rynku.

Materiał obudowy: tworzywo sztuczne

Materiał klosza: PMMA

Kanlux AREL LED is a new family of downlights which do not have a frame. High tightness class IP65/20 and exceptional, simple, and at the same time surprising design make Kanlux AREL LED fit into each interior. Thanks to the unique structure, the panel is only 9 mm thick - it is the thinnest panel available on the market.

Enclosure material: plastic

Lampshade material: PMMA



Model	Code	Power (W)	Color	Beam Diameter (mm)	Beam Length (mm)	Beam Height (mm)
AREL LED DO 6W-NW	29580	6	biały white	410	120	4000
AREL LED DO 6W-WW	29581	6	biały white	380	120	3000
AREL LED DL 6W-NW	29582	6	biały white	410	120	4000
AREL LED DL 6W-WW	29583	6	biały white	380	120	3000
AREL LED DO 10W-NW	29584	10	biały white	830	120	4000
AREL LED DO 10W-WW	29585	10	biały white	790	120	3000
AREL LED DL 10W-NW	29586	10	biały white	830	120	4000
AREL LED DL 10W-WW	29587	10	biały white	790	120	3000
AREL LED DO 14W-NW	29588	14	biały white	1150	120	4000
AREL LED DO 14W-WW	29589	14	biały white	1100	120	3000
AREL LED DL 14W-NW	29590	14	biały white	1150	120	4000
AREL LED DL 14W-WW	29591	14	biały white	1100	120	3000
AREL LED DO 20W-NW	29592	20	biały white	1710	120	4000
AREL LED DO 20W-WW	29593	20	biały white	1650	120	3000
AREL LED DL 20W-NW	29594	20	biały white	1710	120	4000
AREL LED DL 20W-WW	29595	20	biały white	1650	120 </td <td>3000</td>	3000

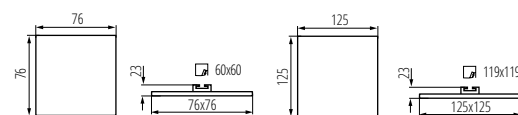

AREL LED DL 6W

AREL LED DL 10W

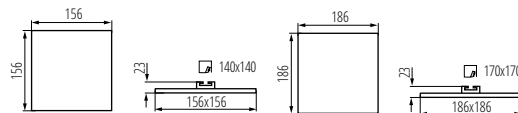

AREL LED DL 14W

AREL LED DL 20W

[V] 220-240 AC	[Hz] 50/60	≥15000	30000	ellipse ≤ 6x MacAdam	Ra ≥80	SMD	IP 65/20
5+25	0,75-1,5	0,5m	CE	ERL			

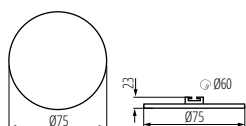

AREL LED DO 6W

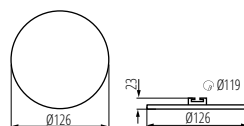

AREL LED DO 10W

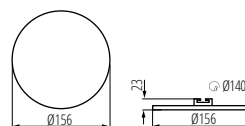

AREL LED DO 14W

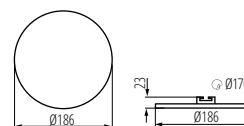

AREL LED DO 20W



ROUNDA V2LED

OPRAWA TYPU DOWNLIGHT ► DOWNLIGHT FITTING



ROUND A V2LED6W-NW-W



ROUND A V2LED12W-NW-SR



ROUND A V2LED18W-NW-SN



ROUND A V2LED24W-NW-SN

ROUND A V2LED12W-NW-SN	27218	5905339272188	12	nikiel satynowy nickel satin	780	110	4000					
ROUND A V2LED18W-NW-SN	27219	5905339272195	18	nikiel satynowy nickel satin	1250	110	4000					
ROUND A V2LED24W-NW-SN	27220	5905339272201	24	nikiel satynowy nickel satin	1700	110	4000					
ROUND A V2LED6W-NW-SN	27221	5905339272218	6	nikiel satynowy nickel satin	300	110	4000					
ROUND A V2LED12W-NW-SR	28930	5905339289308	12	srebrny silver	660	110	4000					
ROUND A V2LED12W-NW-W	28931	5905339289315	12	biały white	780	110	4000					
ROUND A V2LED12W-WW-W	28932	5905339289322	12	biały white	720	110	3000					
ROUND A V2LED18W-NW-SR	28933	5905339289339	18	srebrny silver	1080	110	4000					
ROUND A V2LED18W-NW-W	28934	5905339289346	18	biały white	1260	110	4000					
ROUND A V2LED18W-WW-W	28935	5905339289353	18	biały white	1200	110	3000					
ROUND A V2LED24W-NW-W	28936	5905339289360	24	biały white	1680	110	4000					
ROUND A V2LED6W-NW-W	28937	5905339289377	6	biały white	330	110	4000					
ROUND A V2LED6W-WW-W	28938	5905339289384	6	biały white	300	110	3000					



[V]	[Hz]								
220-240 AC	50/60	≥20000	15000	≥80	SMD			44/20	
5+25			0,05	0,75	0,5m				

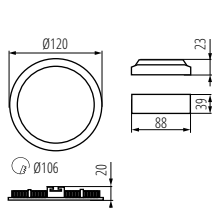

ROUND A V2LED6W

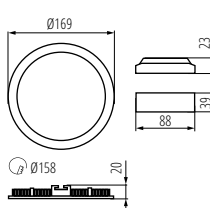

ROUND A V2LED12W

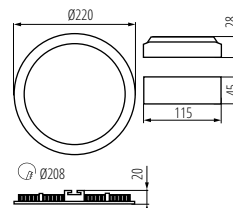

ROUND A V2LED18W

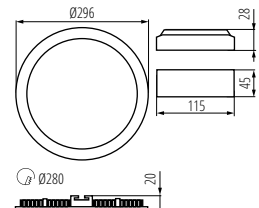

ROUND A V2LED24W



Kanlux ROUNDA V2LED to nowa wersja popularnych okrągłych opraw typu downlight do użytku wewnętrznego. Downlighty te łączą w sobie estetyczne wzornictwo ze światłem uzyskiwanym dzięki technologii LED. Wysoka klasa szczelności IP44 zapobiega wnikaniu wody i kurzu do wnętrza.

Materiał obudowy: stop aluminium

Materiał klosza: tworzywo sztuczne

Kanlux ROUNDA V2LED is a new version of popular round downlight luminaires for indoor use. The downlights combine aesthetic design with light obtained thanks to LED technology. No water or dust can get to the inside owing to the high class of tightness (IP44).

Enclosure material: aluminum alloy

Lampshade material: plastic

KATRO V2LED

OPRAWA TYPU DOWNLIGHT ► DOWNLIGHT FITTING



KATRO V2LED 18W-NW-W



KATRO V2LED 12W-NW-SR



KATRO V2LED 18W-NW-SN



KATRO V2LED 24W-NW-SN



Kanlux KATRO V2LED to nowa wersja opraw KATRO N LED, popularnych kwadratowych downlightów do użytku wewnętrznego. Łączą w sobie estetyczne wzornictwo ze światłem uzyskiwanym dzięki technologii LED. Wysoka klasa szczelności IP44 zapobiega wnikaniu wody i kurzu do wnętrza.

Materiał obudowy: stop aluminium

Materiał klosza: tworzywo sztuczne

Kanlux KATRO V2LED is a new version of KATRO N LED luminaires, popular square downlights for indoor use. They combine aesthetic design with light obtained owing to LED technology. No water or dust can get to the inside owing to the high class of tightness (IP44).

Enclosure material: aluminum alloy

Lampshade material: plastic



KATRO V2LED	Model	Wattage	Color	Length [mm]	Width [mm]	Height [mm]
KATRO V2LED 12W-NW-SN	27214	5905339272140	12 nikiel satynowy nickel satin	780	110	4000
KATRO V2LED 18W-NW-SN	27215	5905339272157	18 nikiel satynowy nickel satin	1250	110	4000
KATRO V2LED 24W-NW-SN	27216	5905339272164	24 nikiel satynowy nickel satin	1700	110	4000
KATRO V2LED 6W-NW-SN	27217	5905339272171	6 nikiel satynowy nickel satin	300	110	4000
KATRO V2LED 12W-NW-SR	28939	5905339289391	12 srebrny silver	660	110	4000
KATRO V2LED 12W-NW-W	28940	5905339289407	12 biały white	780	110	4000
KATRO V2LED 12W-WW-W	28941	5905339289414	12 biały white	720	110	3000
KATRO V2LED 18W-NW-SR	28942	5905339289421	18 srebrny silver	1080	110	4000
KATRO V2LED 18W-NW-W	28943	5905339289438	18 biały white	1260	110	4000
KATRO V2LED 18W-WW-W	28944	5905339289445	18 biały white	1200	110	3000
KATRO V2LED 24W-NW-W	28945	5905339289452	24 biały white	1680	110	4000
KATRO V2LED 6W-NW-W	28946	5905339289469	6 biały white	330	110	4000
KATRO V2LED 6W-WW-W	28947	5905339289476	6 biały white	300	110	3000

[V] 220-240 AC	[Hz] 50/60	[h] ≥20000	[h] 15000	[lm] ≤ 6x MacAdam	Ra ≥80	SMD	CE	ERL	IP 44/20	House icon
5+25	220V	Warranty icon	0,05	0,75	0,5m	RoHS icon	CE	ERL	Kanlux logo	RoHS icon

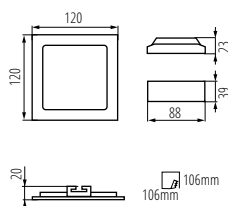

KATRO V2LED 6W

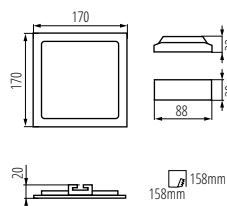

KATRO V2LED 12W

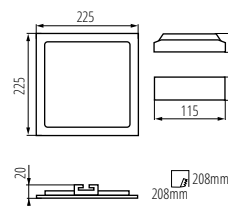

KATRO V2LED 18W

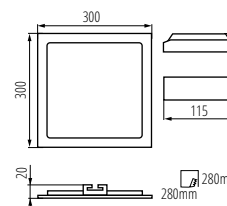

KATRO V2LED 24W

NIKOR

OPRAWA TYPU DOWNLIGHT ► DOWNLIGHT FITTING



NIKOR DLP-60-W



NIKOR DLP-75-W



NIKOR DLP-60-W	07210	5905339072108	max 60	biały white
NIKOR DLP-75-W	07211	5905339072115	max 75	biały white

[V] 220-240 AC	[Hz] 50/60	E27	IP 20	5+25



Kanlux NIKOR to oprawa typu downlight o nowoczesnym wzornictwie. Atrakcyjny wygląd, przemyślana konstrukcja i łatwy montaż to jej główne atuty. Do oprawy dopasujemy wybrane źródło światła z trzonkiem E27. Kanlux NIKOR dzięki nowoczesnemu wzornictwu idealnie pasują zarówno do wnętrz mieszkalnych jak i powierzchni komercyjnych.

Materiał obudowy: stal

Materiał odbłyśnika: stop aluminium

Kanlux NIKOR is a downlight luminaire of modern design. Attractive design, well-thought construction and easy assembly are its core assets. We can match the selected light source with an E27 screw. Owing to their modern design, Kanlux NIKOR perfectly match both residential interiors and commercial spaces.

Enclosure material: steel

Reflector material: aluminum alloy

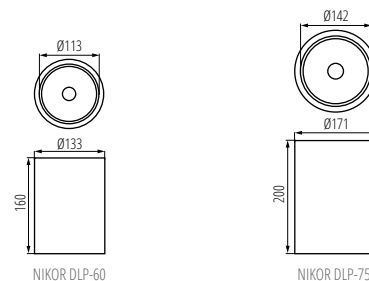

OMERIS

OPRAWA TYPU DOWNLIGHT ► DOWNLIGHT FITTING



OMERIS N LED 35W-NW-W



OMERIS N LED 25W-NW-W



OMERIS N LED 25W-NW-W	23362	5905339233622	25	biały white	1950	85	4000
OMERIS N LED 35W-NW-W	23363	5905339233639	35	biały white	2800	85	4000

[V] 220-240 AC	[Hz] 50/60	≥15000	30000	≤60 MacAdam	Ra ≥80	SMD	IP 20



Kanlux OMERIS to nowoczesna, zintegrowana oprawa typu downlight o prostym uniwersalnym kształcie. Oprawa wykonana jest z aluminium malowanego na kolor biały. Dzięki ponadczasowemu wzornictwu, oprawy Kanlux OMERIS idealnie pasują zarówno do wnętrz mieszkalnych jak i powierzchni komercyjnych.

łatwy montaż, nowoczesny design

Materiał obudowy: stop aluminium

Materiał klosza: tworzywo sztuczne

Kanlux OMERIS is a modern, integrated downlight luminaire of a simple, universal shape. It is made of aluminium painted in white. With their timeless design, Kanlux OMERIS luminaires are perfect for lighting residential interiors and office rooms.

easy installation, modern design

Enclosure material: aluminum alloy

Lampshade material: plastic

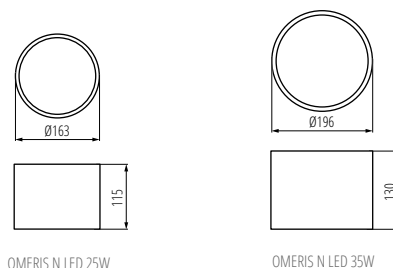

Kanlux

CARSA V2LED

OPRAWA TYPU DOWNLIGHT ► DOWNLIGHT FITTING



CARSA V2LED 12W-NW-SN



Kanlux CARSA V2 LED to okrągła oprawa natynkowa charakteryzująca się harmonijnym połączeniem technologii LED z atrakcyjnym i nowoczesnym wyglądem. Wyróżnia się wysoką energooszczędnością, przy jednoczesnym zachowaniu doskonałych parametrów świetlnych. Kanlux CARSA V2 LED doskonale sprawdza się w oświetleniu wnętrz mieszkalnych jak i pomieszczeń biurowych.

Materiał obudowy: stop aluminium

Materiał klosza: tworzywo sztuczne

Kanlux CARSA V2 LED is a round façade luminaire characterised by harmonious combination of LED technology with attractive and modern looks. It is distinguished by high energy efficiency with maintained excellent light parameters. Kanlux CARSA V2 LED is perfect for lighting residential interiors and office rooms.

Enclosure material: aluminum alloy

Lampshade material: plastic

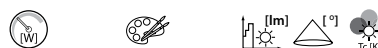

CARSA V2LED 12W-NW-SN	27210	5905339272102	12	nikiel satynowy nickel satin	720	110	4000
CARSA V2LED 18W-NW-SN	27211	5905339272119	18	nikiel satynowy nickel satin	1200	110	4000
CARSA V2LED 12W-NW-W	28948	5905339289483	12	biały white	780	110	4000
CARSA V2LED 18W-NW-W	28949	5905339289490	18	biały white	1260	110	4000

[V] 220-240 AC	[Hz] 50/60	≥20000	(h) 15000	ellipse ≤ 6x MacAdam	Ra ≥80	SMD	0,05	0,75	0,5m
IP 20	5+25	5+25	5+25	5+25	5+25	5+25	5+25	5+25	5+25
CE	ERAC								

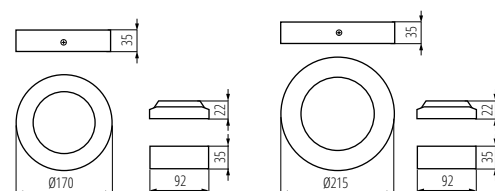

CARSA V2LED 12W

CARSA V2LED 18W

Kanlux

KANTI V2LED

OPRAWA TYPU DOWNLIGHT ► DOWNLIGHT FITTING



KANTI V2LED 18W-NW-SN



Kanlux KANTI V2 LED to kwadratowa oprawa natynkowa charakteryzująca się harmonijnym połączeniem nowoczesnej technologii z atrakcyjnym i nowoczesnym wyglądem. Wyróżnia się wysoką energooszczędnością, przy jednoczesnym zachowaniu doskonałych parametrów świetlnych. Kanlux KANTI V2 LED doskonale sprawdza się w oświetleniu wnętrz mieszkalnych i pomieszczeń biurowych.

Materiał obudowy: stop aluminium

Materiał klosza: tworzywo sztuczne

Kanlux KANTI V2 LED is a square façade luminaire characterised by harmonious combination of modern technology with attractive and modern looks. It is distinguished by high energy efficiency with maintained excellent light parameters. Kanlux KANTI V2 LED is perfect for lighting residential interiors and office rooms.

Enclosure material: aluminum alloy

Lampshade material: plastic



KANTI V2LED 12W-NW-SN	27212	5905339272126	12	nikiel satynowy nickel satin	720	110	4000
KANTI V2LED 18W-NW-SN	27213	5905339272133	18	nikiel satynowy nickel satin	1200	110	4000
KANTI V2LED 12W-NW-W	28950	5905339289506	12	biały white	780	110	4000
KANTI V2LED 18W-NW-W	28951	5905339289513	18	biały white	1260	110	4000

[V] 220-240 AC	[Hz] 50/60	≥20000	(h) 15000	ellipse ≤ 6x MacAdam	Ra ≥80	SMD	0,05	0,75	0,5m
IP 20	5+25	5+25	5+25	5+25	5+25	5+25	5+25	5+25	5+25
CE	ERAC								

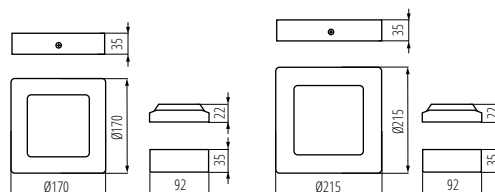

KANTI V2LED 12W

KANTI V2LED 18W

DORTO LED

PROJEKTOR NA SZYNOPRZEWÓD ► RAIL-MOUNTED PROJECTOR



DORTO LED COB-20



DORTO LED COB-40



Kanlux DORTO LED to projektor na szynoprzewód TEAR TR. Dedykowana jest do oświetlenia przestrzeni sklepowych czy wystawowych. System ten z powodzeniem zastosujemy również we wnętrzach mieszkalnych o dużym metrażu. Kanlux DORTO pozwala ciekawie wyeksponować detale lub (w większej ilości) oświetlić wybrany obszar.

do montażu na szynoprzewodzie TEAR TR
Materiał obudowy: stop aluminium
Materiał szyby ochronnej: szkło hartowane
Materiał odbłyśnika: stop aluminium

Kanlux DORTO LED is a projector for TEAR TR busbars. It is dedicated for lighting of store or exhibition spaces. The system also is a good choice for residential spaces of large surface area. Kanlux DORTO allows for interesting highlighting of details or (in larger quantities) illuminating the selected area.

for installation on the TEAR TR busbar
Enclosure material: aluminum alloy
Protective glass material: Tempered glass
Reflector material: aluminum alloy

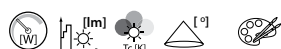

DORTO LED COB-20	22630	5905339226303	20	1565	4000	38	biały white
DORTO LED COB-40	22631	5905339226310	40	2925	4000	60	biały white

[V]	[Hz]		[h]		Ra		
220-240 AC	50/60	≥15000	30000	≤60 MacAdam	≥80	COB	
IP 20							
		5+25		0,5m			

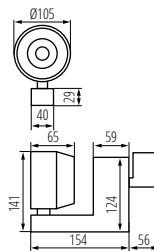

DORTO LED COB-20

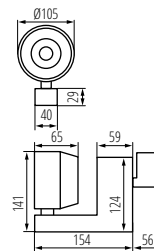

DORTO LED COB-40

TRAKO LED

PROJEKTOR NA SZYNOPRZEWÓD ► RAIL-MOUNTED PROJECTOR



TRAKO LED COB-11



TRAKO LED COB-20



Kanlux TRAKO LED to projektor na szynoprzewód TEAR TR. Przeznaczony jest głównie do oświetlania miejsc w sklepach czy galeriach na które chcemy zwrócić uwagę. Kanlux TRAKO LED będzie znakomicie komponować się z innymi oprawami kompatybilnymi z systemem TEAR.

do montażu na szynoprzewodzie TEAR TR
Materiał obudowy: stop aluminium
Materiał szyby ochronnej: szkło hartowane
Materiał odbłyśnika: stop aluminium

Kanlux TRAKO LED is a projector for TEAR TR busbars. It is designed mainly to illuminate places in shops or galleries which we want to highlight. Kanlux TRAKO LED will perfectly blend in with other luminaires compatible with TEAR system.

for installation on the TEAR TR busbar
Enclosure material: aluminum alloy
Protective glass material: Tempered glass
Reflector material: aluminum alloy

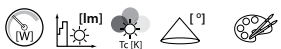

TRAKO LED COB-11	22620	5905339226204	11	750	4000	24	biały white
TRAKO LED COB-20	22621	5905339226211	20	1590	4000	36	biały white

[V]	[Hz]		[h]		Ra		
220-240 AC	50/60	≥15000	30000	≤60 MacAdam	≥80	COB	
IP 20							
		5+25		0,5m			

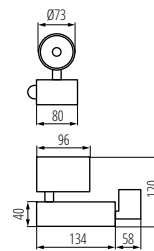

TRAKO LED COB-11

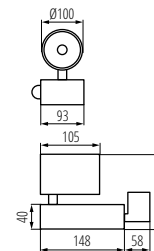

TRAKO LED COB-20

Projektor na szynę / Tracklight				
TEAR PR-90A-WH	22580	5905339225801	Elementy systemu szynowego TEAR (łącznik 90° lewy) TEAR busbar system components (left 90° connector)	służy do połączenia dwóch odcinków szynoprzewodu pod kątem 90° designed for connecting two busbar sections at 90°
TEAR PR-90B-WH	22581	5905339225818	Elementy systemu szynowego TEAR (łącznik 90° prawy) TEAR busbar system components (right 90° connector)	służy do połączenia dwóch odcinków szynoprzewodu pod kątem 90° designed for connecting two busbar sections at 90°
TEAR PR-CORD-WH	22582	5905339225825	Elementy systemu szynowego TEAR (linka stalowa) TEAR busbar system components (steel cord)	
TEAR PR-FLEX-WH	22583	5905339225832	Elementy systemu szynowego TEAR (łącznik) TEAR busbar system components (connector)	służy do połączenia dwóch odcinków szynoprzewodu designed for connecting two busbar sections
TEAR PR-I-B-WH	22584	5905339225849	Elementy systemu szynowego TEAR (łącznik prosty) TEAR busbar system components (straight connector)	służy do liniowego połączenia dwóch odcinków szynoprzewodu designed for linear connection of two busbar sections
TEAR PR-I-WH	22585	5905339225856	Elementy systemu szynowego TEAR (łącznik prosty) TEAR busbar system components (straight connector)	służy do połączenia na kształt litery "I" trzech odcinków szynoprzewodu / designed for connecting three busbar sections into a I shape
TEAR PR-PLUG-WH	22586	5905339225863	Elementy systemu szynowego TEAR (zaśleпка) TEAR busbar system components (end cap)	służy do zaślepienia wolnych końców szynoprzewodu TEAR TR designed for closing free ends of the TEAR TR busbar
TEAR PR-T-LLR-WH	22587	5905339225870	Elementy systemu szynowego TEAR (łącznik "T") TEAR busbar system components (T connector)	służy do połączenia na kształt litery "T" trzech odcinków szynoprzewodu TEAR PR-T: designed for connecting three busbar sections into a T shape
TEAR PR-T-RRL-WH	22589	5905339225894	Elementy systemu szynowego TEAR (łącznik "T") TEAR busbar system components (T connector)	służy do połączenia na kształt litery "T" trzech odcinków szynoprzewodu designed for connecting three busbar sections into a T shape
TEAR PR-WH	22590	5905339225900	Elementy systemu szynowego TEAR (przyłącze prądowe) TEAR busbar system components (current connector)	służy do podłączenia zasilania do szynoprzewodu designed for connecting the power supply to the busbar
TEAR PR-X-WH	22591	5905339225917	Elementy systemu szynowego TEAR (łącznik "X") TEAR busbar system components (X connector)	służy do połączenia na kształt litery "X" czterech odcinków szynoprzewodu designed for connecting four busbar sections into an X shape
TEAR TR 1M-WH	22592	5905339225924	Elementy systemu szynowego TEAR (szynoprzewód 3-obwodowy) TEAR busbar system components (3-circuit busbar)	przeznaczona do zamontowania opraw oświetleniowych TRAKO, DORTO / designed for mounting TRAKO, DORTO fixtures
TEAR TR 2M-WH	22593	5905339225931	Elementy systemu szynowego TEAR (szynoprzewód 3-obwodowy) TEAR busbar system components (3-circuit busbar)	przeznaczona do zamontowania opraw oświetleniowych TRAKO, DORTO / designed for mounting TRAKO, DORTO fixtures



FL MASTER LED

NAŚWIETLACZ LED ► LED FLOODLIGHT



FL MASTER LED 100W-NW



FL MASTER LED 100W-NW



FL MASTER LED 140W-NW



FL MASTER LED 220W-NW

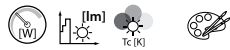

FL MASTER LED 100W-NW	28490	5905339284907	100	13000	4000	czarny black
FL MASTER LED 140W-NW	28491	5905339284914	140	18200	4000	czarny black
FL MASTER LED 220W-NW	28492	5905339284921	220	28600	4000	czarny black

[V] 220-240 AC	[Hz] 50/60	[°] 120	[lm] ≥15000	[h] 50000	[lm] ≤ 6lx Max/beam	Ra ≥80	SMD	1-10V	IP 65	°C -40÷40
	IK 08	[m] 0,4	[m] 1	[m] 1m						



65IP

HIGH
efficacy

BRANDED
components

5+
WARRANTY
5 years

Kanlux FL MASTER to przede wszystkim niezawodność i odporność na warunki atmosferyczne. Jego dodatkowe atuty to wysoka szczelność, stabilna obudowa i zasilacz współpracujący ze ściemniaczem. Markowe komponenty naświetlacza to dodatkowa gwarancja jego skuteczności.

5 lat Gwarancji na warunkach oświadczenia gwarancyjnego, dostępnego na stronie internetowej

Materiał obudowy: stop aluminium

Materiał szyby ochronnej: szkło hartowane

The Kanlux FL MASTER is, above all, about reliability and resistance to weather conditions. Its additional advantages are the high tightness level, stable casing, and power supply, which works with the dimmer. The branded components of the floodlight mean an additional guarantee of its effectiveness.

5 years Warranty under the terms of the warranty statement, available on our website

Enclosure material: aluminum alloy

Protective glass material: Tempered glass

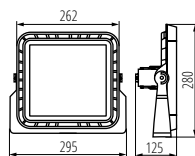

FL MASTER LED 100W

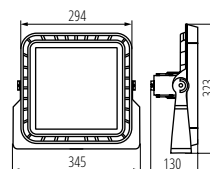

FL MASTER LED 140W

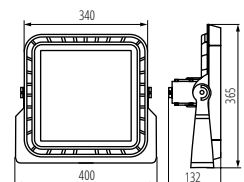

FL MASTER LED 220W

FLM LED

NAŚWIETLACZ LED ▶ LED FLOODLIGHT



FLM LED 100W-NW



FLM LED 100W-NW



FLM LED 140W-NW



FLM LED 220W-NW



Model	Code	Power [W]	Beam Angle [°]	Luminous Flux [lm]	Beam Diameter [mm]	Beam Diameter at 1m [mm]	Beam Diameter at 2m [mm]	Color
FLM LED 100W-NW-60D	28520	5905339285201	100	12750	4000	60		czarny black
FLM LED 100W-NW110/150	28521	5905339285218	100	12100	4000	X110/Y150		czarny black
FLM LED 140W-NW-60D	28522	5905339285225	140	17850	4000	60		czarny black
FLM LED 140W-NW110/150	28523	5905339285232	140	16950	4000	X110/Y150		czarny black
FLM LED 220W-NW-60D	28524	5905339285249	220	28050	4000	60		czarny black
FLM LED 220W-NW110/150	28525	5905339285256	220	26600	4000	X110/Y150		czarny black

[V]	[Hz]	⚡	(h)	⊕ ellipse	Ra	⊙ SMD	⚡	⚡	IP	🏠	🌡️
220-240 AC	50/60	≥15000	50000	≤ 6x MacAdam	≥80			65			-40+40
🔧	180	IK 08	🔧	0,4	1	1m	🔧	CE	ERL	🔧	Kanlux

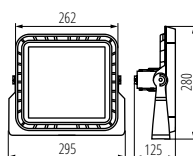

FLM LED 100W

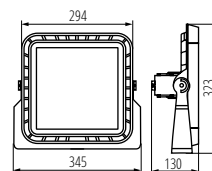

FLM LED 140W

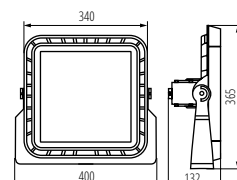

FLM LED 220W



65IP

HIGH
efficacy

BRANDED
components

5
WARRANTY
5 years

Naświetlacz Kanlux FLM MASTER to specjalna wersja naświetlacza FL MASTER, który wyposażony jest w dodatkowe typy soczewek: wąskostrumieniową - która zmienia kąt świecenia na 60° lub asymetryczną przy której kąt świecenia wynosi odpowiednio: X=110°, Y=150.

Produkty na indywidualne zamówienie po konsultacji z działem handlowym.

5 lat Gwarancji na warunkach oświadczenia gwarancyjnego, dostępnego na stronie internetowej

Materiał obudowy: stop aluminium

Materiał szyby ochronnej: szkło hartowane

Kanlux FLM MASTER floodlight is a special version of the FL MASTER floodlight, which is equipped with additional types of lenses - narrow-beam - which changes the angle of illumination to 60° - or asymmetrical - for which the beam angle is respectively: X=110°, Y=150.

Products available on individual order after consultation with the sales department

5 years Warranty under the terms of the warranty statement, available on our website

Enclosure material: aluminum alloy

Protective glass material: Tempered glass

ANTRA LED

NAŚWIETLACZ LED ► LED FLOODLIGHT



ANTRA LED100W-NW GR



ANTRA LED10W-NW-SE GR	25580	5905339255808	10	750	4000	44	szary grey	PIR
ANTRA LED30W-NW-SE GR	25581	5905339255815	30	2300	4000	44	szary grey	PIR
ANTRA LED50W-NW-SE GR	25582	5905339255822	50	3700	4000	44	szary grey	PIR
ANTRA LED10W-NW GR	25583	5905339255839	10	750	4000	65	szary grey	
ANTRA LED30W-NW GR	25584	5905339255846	30	2300	4000	65	szary grey	
ANTRA LED50W-NW GR	25585	5905339255853	50	3700	4000	65	szary grey	
ANTRA LED100W-NW GR	25586	5905339255860	100	7400	4000	65	szary grey	
ANTRA LED150W-NW GR	25587	5905339255877	150	11900	4000	65	szary grey	
ANTRA LED20W-NW-SE GR	25588	5905339255884	20	1500	4000	44	szary grey	PIR
ANTRA LED20W-NW GR	25589	5905339255891	20	1500	4000	65	szary grey	
ANTRA LED200W-NW GR	25700	5905339257000	200	15000	4000	65	szary grey	
ANTRA LED10W-NW-SE B	25701	5905339257017	10	750	4000	44	czarny black	PIR
ANTRA LED20W-NW-SE B	25702	5905339257024	20	1500	4000	44	czarny black	PIR
ANTRA LED10W-NW B	25703	5905339257031	10	750	4000	65	czarny black	
ANTRA LED20W-NW B	25704	5905339257048	20	1500	4000	65	czarny black	
ANTRA LED30W-NW B	25705	5905339257055	30	2300	4000	65	czarny black	
ANTRA LED30W-NW-SE B	25706	5905339257062	30	2300	4000	44	czarny black	PIR
ANTRA LED50W-NW B	25707	5905339257079	50	3700	4000	65	czarny black	
ANTRA LED50W-NW-SE B	25708	5905339257086	50	3700	4000	44	czarny black	PIR

[V] 220-240 AC	[Hz] 50/60	△ 110	□ ≥15000	⌚ 25000	⊕ ellipse ≤ 6x MacAdam	☀️ Ra ≥80	
	[mm] 0,2	[mm] 1	[mm] 0,5m				



Naświetlacze Kanlux ANTRA LED idealne są do oświetlania zewnętrznych elewacji czy okolic posesji. Sprawdzają się też przy tworzeniu kompozycji świetlnych w ogrodach, na działkach czy w parkach.

Materiał obudowy: stop aluminium

Materiał szyby ochronnej: szkło hartowane

Materiał odbłyśnika: stop aluminium

Kanlux ANTRA LED floodlights are perfect for illuminating external façades or areas surrounding the property. They are a good choice for creating light compositions in gardens, plots and parks.

Floodlight ANTRA LED + SE - version with a motion sensor

Enclosure material: aluminum alloy

Protective glass material: Tempered glass

Reflector material: aluminum alloy



ANTRA LED50W-NW-SE GR



ANTRA LED50W-NW-SE B



ANTRA LED50W-NW B



B / GR

ANTRA LED

NAŚWIETLACZ LED ► LED FLOODLIGHT

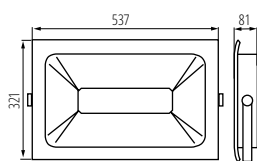

ANTRA LED200W

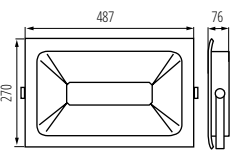

ANTRA LED150W

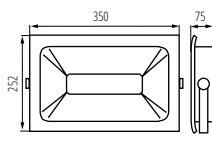

ANTRA LED100W

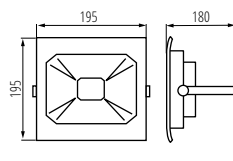

ANTRA LED 50W

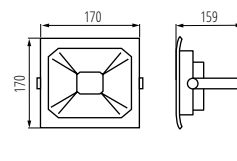

ANTRA LED 20W; 30W

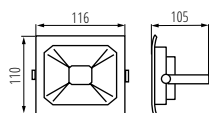

ANTRA LED 10W

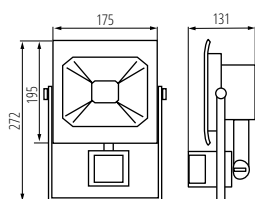

ANTRA LED 50W SE

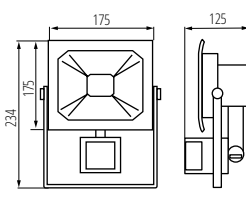

ANTRA LED 20W; 30W SE

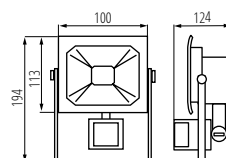

ANTRA LED10W SE



ANTOS LED

NAŚWIETLACZ LED ► LED FLOODLIGHT



ANTOS LED 10W-NW-SE B



ANTOS LED 20W-NW B



ANTOS LED 30W-NW B



ANTOS LED 50W-NW-SE B



Kanlux ANTOS LED to stylowe, ultrakompaktowe naświetlacze LED. Ważną cechą tych opraw jest wyprofilowany wysięgnik, dzięki któremu możemy zamocować je bez konieczności demontażu uchwytu.

Wersja naświetlacza ANTOS + SE - z czujnikiem ruchu
Materiał obudowy: stop aluminium
Materiał szyby ochronnej: szkło hartowane
Materiał odbłyśnika: stop aluminium

Kanlux ANTOS LED are stylish, ultra-compact LED floodlights. What is important, the luminaires have a profiled arm allowing for mounting with no need to disassemble the handle.

Version of the floodlight ANTOS + SE - with a motion sensor

Enclosure material: aluminum alloy

Protective glass material: Tempered glass

Reflector material: aluminum alloy



Model	Code	Power [W]	Beam angle [°]	Light output [lm]	IP	Color
ANTOS LED 10W-NW B	27090	10	800	4000	65	czarny black
ANTOS LED 20W-NW B	27091	20	1600	4000	65	czarny black
ANTOS LED 30W-NW B	27092	30	2400	4000	65	czarny black
ANTOS LED 50W-NW B	27093	50	4000	4000	65	czarny black
ANTOS LED 10W-NW-SE B	27094	10	800	4000	44	czarny black PIR
ANTOS LED 20W-NW-SE B	27095	20	1600	4000	44	czarny black PIR
ANTOS LED 30W-NW-SE B	27096	30	2400	4000	44	czarny black PIR
ANTOS LED 50W-NW-SE B	27097	50	4000	4000	44	czarny black PIR

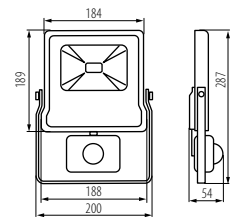

ANTOS LED 50W-SE

[V] 220-240 AC	[Hz] 50/60	[°] 120	[lm] ≥15000	[h] 25000	[Ra] ≥80	[SMD]	[Sensor]
[Grounding]	[Household]	[Temp] -20÷35	[Beam]	[Beam]	[Beam]	[Beam]	[Beam]
[No touch]	CE	EAC	Kanlux				

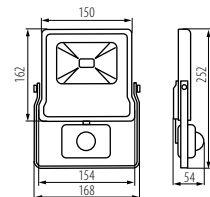

ANTOS LED 30W-SE

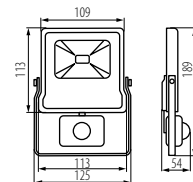

ANTOS LED 20W-SE

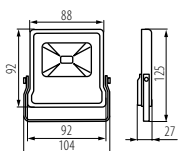

ANTOS LED 10W

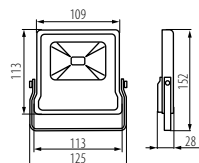

ANTOS LED 20W

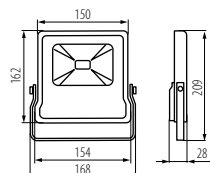

ANTOS LED 30W

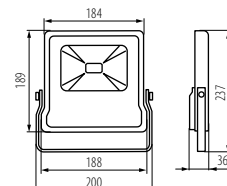

ANTOS LED 50W

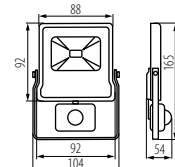

ANTOS LED 10W-SE

Kanlux STATO LED

NAŚWIETLACZ LED ▶ LED FLOODLIGHT

NEW



STATO LED



Kanlux STATO LED to przenośny naświetlacz o wysokiej szczelności (IP65). Polecany jako oświetlenie przy remontach czy pracach budowlanych. Regulacja kąta nachylenia naświetlacza i statywu pozwala na doświetlanie powierzchni w wielu płaszczyznach, wyższy współczynnik oddawania barw niż większość naświetlaczy (CRI>80) to możliwość używania wewnątrz pomieszczeń (przy remontach lepiej widać barwy oświetlanej powierzchni). W Kanlux STATO LED w komplecie znajduje się 2 metrowy kabel z wtyczką.

Materiał obudowy: stop aluminium
Materiał szyby ochronnej: szkło hartowane
Materiał wysięgnika: stal

Kanlux STATO LED is a portable floodlight with high tightness (IP65). Recommended as lighting during renovations or building works. Adjustment of the inclination angle of the floodlight and the stand allows to additionally light up surface in a lot of planes, higher colour rendering index than most floodlights (CRI>80) is a possibility of using inside rooms (during renovations, colours of lighted surface are better visible). In Kanlux STATO LED the set contains a 2-metre cable with a plug.

Enclosure material: aluminum alloy
Protective glass material: Tempered glass
Extension-arm material: steel



STATO LED 30W-B	29220	5905339292209	30	2700	4000	czarny black
STATO LED 50W-B	29221	5905339292216	50	4500	4000	czarny black

[V]	[Hz]	[°]	[lm]	[h]	[lm]	[Ra]	[SMD]	[IP]
220-240 AC	50/60	120	≥15000	25000	≤6x Nachdam	≥80	SMD	IP 65
[°C]	[m]	[mm]	[m]	[m]	[m]	[m]	[m]	[m]
-20+35	2	1	1m	1m	1m	1m	1m	1m

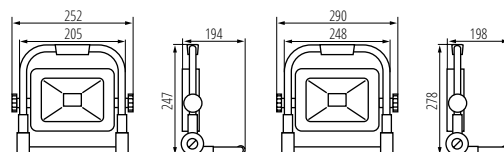

STATO LED 30W-B

STATO LED 50W-B

Kanlux ELIOT

NAŚWIETLACZ Z WYMIENNYM ŹRÓDŁEM ŚWIATŁA ▶ FLOODLIGHT WITH REPLACEABLE LIGHT SOURCE



ELIOT ZW3-L500P-B



ELIOT ZW3-L500P-B	00620	5905339006202	max 500	J-118mm	R7s	czarny black
-------------------	--------------	---------------	---------	---------	-----	----------------

[V]	[Hz]	[IP]	[°C]	[m]	[mm]	[m]	[m]	[m]
220-240 AC	50/60	54	-20+35	1,7	1	1m	1m	1m
[°]	[m]	[mm]	[m]	[m]	[m]	[m]	[m]	[m]
50	1,7	1	1m	1m	1m	1m	1m	1m



Przenośny naświetlacz Kanlux ELIOT to praktyczne rozwiązanie dla tych, którzy potrzebują dodatkowego, mobilnego źródła oświetlenia. Oprawa posiada wysoki stopień szczelności IP54.

Materiał obudowy: stop aluminium
Materiał szyby ochronnej: szkło hartowane
Materiał odbłyśnika: stop aluminium

Kanlux ELIOT mobile floodlight is a practical solution for everyone who needs additional, mobile light source. The luminaire has a high rating of tightness IP54.

Enclosure material: aluminum alloy
Protective glass material: Tempered glass
Reflector material: aluminum alloy

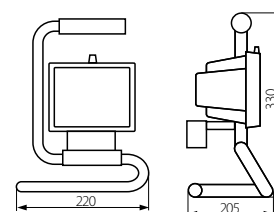

ELIOT ZW3-L500P-B

Kanlux

AVIA MTH

NAŚWIETLACZ Z WYMIENNYM ŹRÓDŁEM ŚWIATŁA
▶ FLOODLIGHT WITH REPLACEABLE LIGHT SOURCE



AVIA MTH-478/400W-B



AVIA MTH-478/400W-B



AVIA MTH-478/250W-B

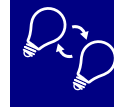

IP65

Kanlux AVIA MTH to naświetlacz z wymiennym źródłem światła o trzonku E40. Posiada wysoki stopień szczelności IP65, świetnie więc sprawdzi się w oświetleniu dużych obiektów, tj. boisk, hal, parkingów, placów itp.

Materiał obudowy: stop aluminium

Materiał szyby ochronnej: szkło hartowane

Materiał odbłyśnika: stop aluminium

Kanlux AVIA MTH is a floodlight with a replaceable light source with an E40 screw. Owing to the high rating of tightness IP65, it is a good choice for lighting large venues, e.g. pitches, halls, parking lots, squares, etc.

Enclosure material: aluminum alloy

Protective glass material: Tempered glass

Reflector material: aluminum alloy



AVIA MTH-478/400W-B	04011	5905339040114	400	MTH	E40	czarny black
AVIA MTH-478/250W-B	04013	5905339040138	250	MTH	E40	czarny black

[V] 220-240 AC	[Hz] 50/60	METALHALIDE	IP 65	°C -20÷35	[L] 180
1-2,5	2m				

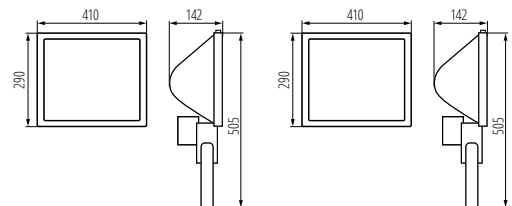

AVIA MTH-400W

AVIA MTH-250W

Kanlux

ADAMO MTH

NAŚWIETLACZ Z WYMIENNYM ŹRÓDŁEM ŚWIATŁA
▶ FLOODLIGHT WITH REPLACEABLE LIGHT SOURCE



ADAMO MTH-250/S



ADAMO MTH-250/A



ADAMO MTH-400/S



ADAMO MTH-400/A



Kanlux ADAMO MTH to naświetlacz metalohalogenkowy z wymiennym źródłem światła. Posiada wysoki stopień szczelności IP65, świetnie więc sprawdzi się w oświetleniu dużych obiektów, tj. boisk, hal, parkingów, placów itp.

Materiał obudowy: stop aluminium
Materiał szyby ochronnej: szkło hartowane
Materiał odbłyśnika: stop aluminium

Kanlux ADAMO MTH is a metal-halide floodlight with a replaceable light source. Owing to the high rating of tightness IP65, it is a good choice for lighting large venues, e.g. pitches, halls, parking lots, squares, etc.

Enclosure material: aluminum alloy
Protective glass material: Tempered glass
Reflector material: aluminum alloy



ADAMO MTH-250/S	04841	5905339048417	250	MTH	E40	czarny black
ADAMO MTH-400/S	04842	5905339048424	400	MTH	E40	czarny black
ADAMO MTH-250/A	04845	5905339048455	250	MTH	E40	czarny black
ADAMO MTH-400/A	04846	5905339048462	400	MTH	E40	czarny black

[V] 220-240 AC	[Hz] 50/60	METALHALIDE	IP 65	[-20+35]	180
1-2,5	2m	CE			

AKCESORIA ▶ ACCESSORIES

GL-ADAMO 250/400	72372	5905339723727	szybka ochronna do oprawy ADAMO MTH, GL-ADAMO 250/400, (72372) / protective glass for ADAMO MTH light fixtures, GL-ADAMO 250/400, (72372)
------------------	--------------	---------------	---

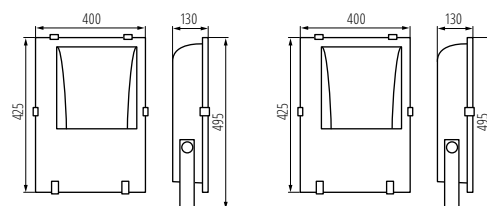

ADAMO MTH-250

ADAMO MTH-400

HB MASTER LED

OPRAWA LED HIGH BAY ► HIGH-BAY LED LIGHT FITTING



HB MASTER LED 100W



HB MASTER LED 100W



HB MASTER LED 150W



HB MASTER LED 200W

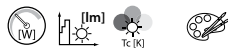

HB MASTER LED 100W	28530	5905339285300	100	13000	4000	czarny black
HB MASTER LED 150W	28531	5905339285317	150	19500	4000	czarny black
HB MASTER LED 200W	28532	5905339285324	200	26000	4000	czarny black

[V]	[Hz]	[°]	[lm]	[h]	[mm]	[mm]	[mm]	[mm]
220-240 AC	50/60	120	≥15000	50000	≤ 6x MacAdam	Ra ≥80	SMD	0,4
IP 65			[-30+40]		IK 08			1
1m								



IP65

HIGH BAY
efficiency

BRANDED
components

5+
WARRANTY
5 years

Kanlux HB MASTER to profesjonalne oprawy oświetleniowe typu HIGH BAY. Oprawy te mają szereg akcesoriów, dzięki którym zmodyfikujesz oprawę. Uchwyty, klosze, soczewki, siatki ochronne - wszystko aby spełnić wymagania każdej inwestycji.

5 lat Gwarancji na warunkach oświadczenia gwarancyjnego, dostępnego na stronie internetowej

Materiał obudowy: stop aluminium

Materiał szyby ochronnej: szkło hartowane

The Kanlux HB MASTER floodlight is one of the professional HIGH BAY fixture range. These fixtures have a variety of accessories which will allow you to modify them. Handles, lampshades, lenses, protective nets - everything to meet the requirements of any investment.

5 years Warranty under the terms of the warranty statement, available on our website

Enclosure material: aluminum alloy

Protective glass material: Tempered glass

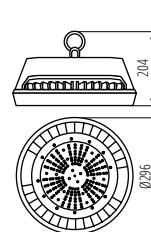

HB MASTER LED 100W, HB MASTER LED 150W

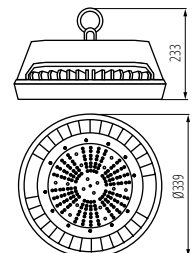

HB MASTER LED 200W

HB MASTER LED

OPRAWA LED HIGH BAY ► HIGH-BAY LED LIGHT FITTING



HBM BRACKET 100/150/200W



HBM GRID 100/150/200W



HBM LENS 60D 100/150/200W



HBM LENS 90D 100/150/200W



HBM PC 100D 100/150W



HBM REF ALU100/150W



HBM REF PC100/150W



HBM PC 100D 200W



HBM REF ALU200W



HBM REF PC200W

AKCESORIA ► ACCESSORIES

HBM BRACKET 100/150W	28543	Uchwyt montażowy do oprawy HB MASTER 100W, 150W Assembly handle for HB MASTER 100W & 150W fixtures
HBM GRID 100/150W	28545	Siatka ochronna do oprawy HB MASTER 100W, 150W Protective net for HB MASTER 100W & 150W fixtures
HBM LENS 60D 100/150W	28537	Soczewka 60 stopni do oprawy HB MASTER 100W, 150W 60-degree lens for HB MASTER 100W & 150W fixtures
HBM LENS 90D 100/150W	28538	Soczewka 90 stopni do oprawy HB MASTER 100W, 150W 90-degree lens for HB MASTER 100W & 150W fixtures
HBM PC 100D 100/150W	28539	Oslona PC zapewniająca IK10 do oprawy HB MASTER 100W, 150W PC cover providing IK10 for HB MASTER 100W & 150W fixtures
HBM REF ALU100/150W	28533	Klosz ALU do oprawy HB MASTER 100W, 150W ALU lampshade for HB MASTER 100W & 150W fixtures
HBM REF PC100/150W	28535	Klosz PC do oprawy HB MASTER 100W, 150W PC lampshade for HB MASTER 100W & 150W fixtures
HBM BRACKET 200W	28544	Uchwyt montażowy do oprawy HB MASTER 200W Assembly handle for HB MASTER 200W fixture
HBM GRID 200W	28546	Siatka ochronna do oprawy HB MASTER 200W Protective net for HB MASTER 200W fixture
HBM LENS 60D 200W	28540	Soczewka 60 stopni do oprawy HB MASTER 200W 60-degree lens for HB MASTER 200W fixture
HBM LENS 90D 200W	28541	Soczewka 90 stopni do oprawy HB MASTER 200W 90-degree lens for HB MASTER 200W fixture
HBM PC 100D 200W	28542	Oslona PC zapewniająca IK10 do oprawy HB MASTER 200W PC cover providing IK10 for HB MASTER 200W fixture
HBM REF ALU200W	28534	Klosz ALU do oprawy HB MASTER 200W ALU lampshade for HB MASTER 200W fixture
HBM REF PC200W	28536	Klosz PC do oprawy HB MASTER 200W PC lampshade for HB MASTER 200W fixture

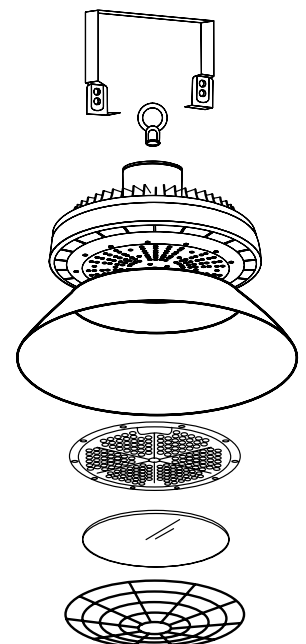

HB PRO LED

OPRAWA LED HIGH BAY ► HIGH-BAY LED LIGHT FITTING



HB PRO LED 100W-NW



HB PRO LED 100W-NW



HB PRO LED 150W-NW



Kanlux HB PRO LED to oprawy typu „High Bay”. Oprócz energooszczędności jaką gwarantuje zastosowana w nich technologia LED, cechuje je też niezwykle duża trwałość i wysoki stopień szczelności IP65. Idealnie sprawdzą się w wysokich halach magazynowych, produkcyjnych czy sklepowych, a także w nowoczesnych loftach.

5 lat Gwarancji na warunkach oświadczenia gwarancyjnego, dostępnego na stronie internetowej Atest PZH: Numer BK/K/0536/01/2018, ważny do 2023-07-02

Materiał obudowy: stop aluminium

Materiał klosza: tworzywo sztuczne

Materiał szyby ochronnej: tworzywo sztuczne

Kanlux HB MASTER to profesjonalne oprawy oświetleniowe typu HIGH BAY. Oprawy te mają szereg akcesoriów, dzięki którym zmodyfikujesz oprawę. Uchwyty, klosze, soczewki, siatki ochronne - wszystko aby spełnić wymagania każdej inwestycji. Kanlux HB PRO LED are “High Bay” luminaires. Apart from the energy efficiency of the applied LED technology, they are characterised by extremely high durability and a high rating of tightness IP65. It is a perfect choice for high-storage, production or shop halls and modern lofts.

5 years Warranty under the terms of the warranty statement, available on our website

Enclosure material: aluminum alloy

Lampshade material: plastic

Protective glass material: plastic

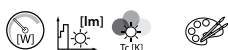

HB PRO LED 100W-NW	27150	5905339271501	100	12000	4000	czarny black
HB PRO LED 150W-NW	27151	5905339271518	150	18000	4000	czarny black

[V]	[Hz]	[°]	[lm]	[h]	[Ra]	[SMD]	[IP]	[°C]	[mm]	[mm]
220-240 AC	50/60	90	≥25000	50000	≤6x MacAdam	≥80	IP65	-20+40	30	1
1m	CE	EAC								

AKCESORIA ► ACCESSORIES

HB REF 15 AL	27152	5905339271525	Klosz do opraw HB PRO 100W, HB REF 15 AL, srebrny,(27152) / Shade for fittings HB PRO 100W, HB REF 15 AL, silver,(27152)			
HB REF 17 AL	27153	5905339271532	Klosz do opraw HB PRO 150W, HB REF 17 AL, srebrny,(27153) / Shade for fitting HB PRO 150W, HB REF 17 AL, silver,(27153)			

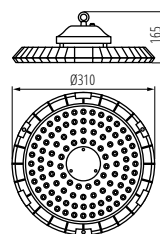

HB PRO LED 100W

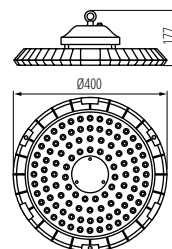

HB PRO LED 150W

EURO MTH

OPRAWA METALOHALOGENOWA HIGH BAY
▶ HIGH-BAY METAL HALIDE LIGHT FITTING



EURO MTH-250-16PC



Oprawa metalohalogenowa Kanlux EURO MTH to rozwiązanie typu „High Bay” na wymienne źródło światła o trzonku E40. Przeznaczona jest do oświetlenia hal przemysłowych, magazynów, warsztatów czy większych przestrzeni handlowych.

Materiał obudowy: stop aluminium

Kanlux EURO MTH metal-halogen luminaire is a “High Bay” solution using a replaceable light source with an E40 screw. It is designed for lighting of industrial halls, storehouses, workshops or large commercial spaces.

Enclosure material: aluminum alloy



EURO MTH-250-16PC



EURO MTH-250-22PC



EURO MTH-250-21AL



EURO MTH-250-16PC	07860	5905339588128	250	MTH	E40	szary grey
EURO MTH-400-16PC	07861	5905339588159	400	MTH	E40	szary grey
EURO MTH-250-22PC	07862	5905339588142	250	MTH	E40	szary grey
EURO MTH-400-22PC	07863	5905339588173	400	MTH	E40	szary grey
EURO MTH-250-21AL	07864	5905339588135	250	MTH	E40	szary grey
EURO MTH-400-21AL	07865	5905339588166	400	MTH	E40	szary grey

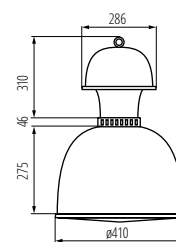

EURO MTH-250/400-16PC

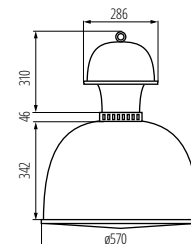

EURO MTH-250/400-22PC

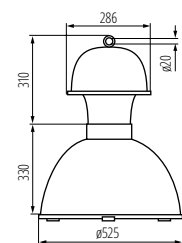

EURO MTH-250/400-21AL



STREET LED

OPRAWA PARKINGOWA LED ► PARKING LIGHTING LED



STREET LED 4000 NW



STREET LED 4000 NW

STREET LED 8000 NW

STREET LED 12000 NW



Model	Code	Part No.	Watt	lm	Beam	Temp	Color
STREET LED 4000 NW	27330	5905339273307	30	3900	4000	X100/Y145	szary grey
STREET LED 8000 NW	27331	5905339273314	60	7800	4000	X100/Y145	szary grey
STREET LED 12000 NW	27332	5905339273321	90	11700	4000	X100/Y145	szary grey

[V]	[Hz]	[lm]	[h]	[SMD]	[IP]	[Temp]
220-240 AC	50/60	≥20000	35000	SMD	IP 65	-35+40
[mm]	[mm]	[m]	[CE]	[EAC]	[Kanlux]	
0,4	1	1m				

AKCESORIA ► ACCESSORIES

STREET LED ADTR 15D	27333	5905339273338	Regulowany adapter do opraw parkingowych, STREET LED ADTR 15D, szary (27333) / Adjustable adaptor intended for installing STREET LED parking fixtures on vertical posts with Ø 60mm to Ø 63mm diameter ends.				
---------------------	-------	---------------	---	--	--	--	--



Kanlux STREET LED wyposażone są w diody bardzo wysokiej jakości, które umieszczone są na wymiennych modułach. Ich skuteczność to 130 lumenów z Wata! Ich nowoczesny design bardzo dobrze komponuje się z przestrzenią miejską. Do opraw polecamy adapter ADTR15D.

Materiał obudowy: stop aluminium
Materiał klosza: tworzywo sztuczne

The Kanlux STREET LED is equipped with very-high quality LED's, which are fitted in replaceable modules. Their efficacy is at least 130 lumen for 1 Watt! Their modern design fits in very well with urban spaces. We recommend the ADTR15D adapter for these fixtures.

Enclosure material: aluminum alloy
Lampshade material: plastic

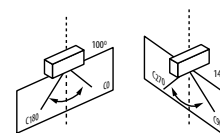
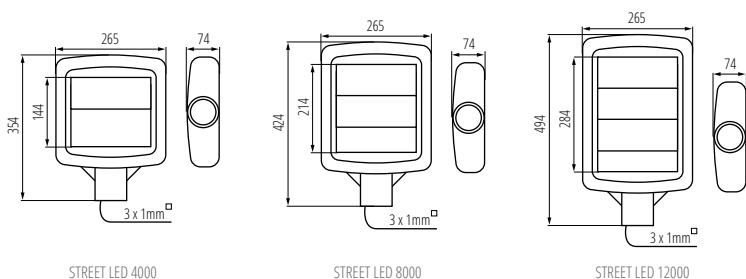



LART EL

OPRAWA ELEWACYJNA ► FACADE LUMINAIRE



LART EL-160-GR



LART EL-160-GR



LART EL-260-GR

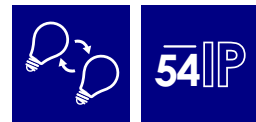

Seria elewacyjnych opraw Kanlux LART to surowa i jednocześnie klasyczna linia opraw fasadowych w obudowie wykonanej z aluminium. Powierzchnia zewnętrzna oprawy wykończona jest w kolorze grafitowym. Kanlux LART perfekcyjnie prezentują się zarówno w pojedynkę jak i w instalacji kilku opraw - subtelnie dopełniając świetlne aranżacje na tarasach czy elewacjach budynków.

Materiał obudowy: stop aluminium
Materiał szyby ochronnej: szkło

A series of facade Kanlux LART luminaires is a raw and at the same time classic line of facade luminaires in a casing made of aluminium. The external surface of the luminaire is completed in a graphite colour. Kanlux LART look perfect both on a single basis and in combination of several luminaires - subtly complementing light arrangements on terraces or facades of buildings.

Enclosure material: aluminum alloy
Protective glass material: glass

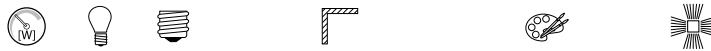

LART EL-160-GR	29832	5905339298324	60	GLS/CFL/LED	E27	do nadbudowania na ścianie wall mounted	antracyt anthracite	dół down
LART EL-260-GR	29833	5905339298331	2x60	GLS/CFL/LED	E27	do nadbudowania na ścianie wall mounted	antracyt anthracite	góra i dół up and down

[V] 220-240 AC	[Hz] 50/60	Light bulb icon	Grounding icon	IP 54	0,5m	Mounting icon
Temperature icon -20+25	Mounting icon	Beam spread icon 1+2,5	CE	ERAC	Kanlux logo	Color selection icon

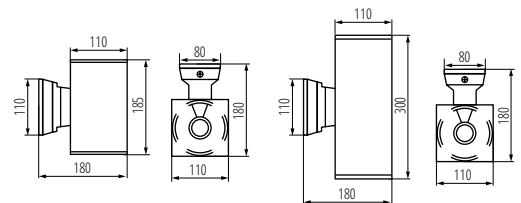

LART EL-160-GR

LART EL-260-GR

BART EL

OPRAWA ELEWACYJNA ► FACADE LUMINAIRE



BART EL-135



BART EL-235



BART EL-160



BART EL-260



Kanlux BART EL to oprawa natynkowa, która świetnie wkomponuje się zarówno w elewację nowoczesnego budynku jak i zabudowania o bardziej klasycznej stylistyce. Stopień szczelności IP54, jaki posiada oprawa Kanlux BART EL gwarantuje odporność na działanie czynników atmosferycznych.

Materiał obudowy: stop aluminium

Materiał szyby ochronnej: szkło hartowane

Kanlux BART EL is a façade luminaire which perfectly blends into a modern building and constructions of a more classic style. The rating of tightness (IP54) of Kanlux BART EL luminaire ensures resistance to weather conditions.

Enclosure material: aluminum alloy

Protective glass material: Tempered glass

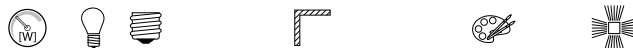

BART EL-135	07079	5905339070791	max 35	PAR16	GU10	do nadbudowania na ścianie wall mounted	szary grey	góra Top
BART EL-235	07080	5905339070807	2 x max 35	PAR16	GU10	do nadbudowania na ścianie wall mounted	szary grey	góra i dół up and down
BART EL-160	07081	5905339070814	max 60	A60	E27	do nadbudowania na ścianie wall mounted	szary grey	góra Top
BART EL-260	07082	5905339070821	2 x max 60	A60	E27	do nadbudowania na ścianie wall mounted	szary grey	góra i dół up and down

[VI] 220-240 AC	[Hz] 50/60			IP 54	 0,5m		 -20+35	
	 1+2,5	CE	ERC	 Kanlux A+ A- A B C D E				

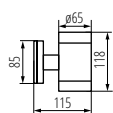

BART EL-135

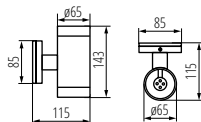

BART EL-235

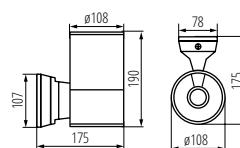

BART EL-160

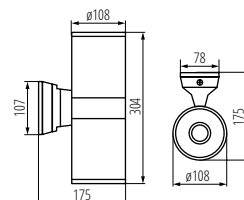

BART EL-260

Kanlux

BART DL

OPRAWA ELEWACYJNA ► FACADE LUMINAIRE



BART DL-125



BART DL-160



Kanlux BART DL to klasyczny design, do którego sami dobierzecie źródło światła (polecamy szczególnie źródła IQ-LED lub PRO GU10). Oprawa Kanlux BART DL ma wysoką klasę szczelności, dlatego też świetnie nadaje się do zamontowania na stropie lub na podsufitce na zewnątrz.

Materiał obudowy: stop aluminium
Materiał szyby ochronnej: szkło hartowane

The Kanlux BART DL is a classic design for which you can choose a light source (we especially recommend IQ-LED or PRO GU10 sources). The Kanlux BART DL fixture has a high tightness classification, so it is perfect for installation on the ceiling or on a soffit outside.

Enclosure material: aluminum alloy
Protective glass material: Tempered glass

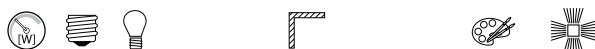

BART DL-125	28800	5905339288004	max 25	GU10	PAR16	do nadbudowania na suficie	ceiling mounted	szary grey	dół down
BART DL-160	28801	5905339288011	max 60	E27	A60	do nadbudowania na suficie	ceiling mounted	szary grey	dół down

[V]	[Hz]	Light bulb icon	Grounding symbol	IP	Distance icon	House icon	Temperature icon	Mounting icon
220-240 AC	50/60			54	0,5m		-20÷35	
Light bulb icon	Light bulb icon	Light bulb icon	CE	ERAC	Kanlux logo and A-E energy efficiency scale			

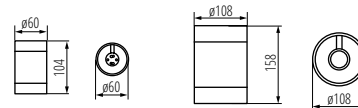

BART DL-125

BART DL-160

Kanlux

MAGRA EL

OPRAWA ELEWACYJNA ► FACADE LUMINAIRE



MAGRA EL-135



MAGRA EL-235



Kanlux MAGRA EL to ścienny kinkiet zewnętrzny w szarym, neutralnym kolorze. Zbudowany ze stali nierdzewnej i szkła hartowanego zapewnia trwałość i komfort użytkowania.

Materiał obudowy: stal nierdzewna
Materiał szyby ochronnej: szkło hartowane

Kanlux MAGRA EL is an external sconce in gray, neutral colour. It is made of stainless steel and tempered glass, ensuring durability and comfort of use.

Enclosure material: stainless steel
Protective glass material: Tempered glass



MAGRA EL-135	18010	5905339180100	1 x max 35	PAR16	GU10	do nadbudowania na ścianie	wall mounted	stal nierdzewna stainless steel	góra Top
MAGRA EL-235	18011	5905339180117	2 x max 35	PAR16	GU10	do nadbudowania na ścianie	wall mounted	stal nierdzewna stainless steel	góra i dół up and down

[V]	[Hz]	Light bulb icon	Grounding symbol	IP	Distance icon	House icon	Temperature icon	Mounting icon
220-240 AC	50/60			44	0,5m		-20÷35	
Light bulb icon	Light bulb icon	Light bulb icon	CE	ERAC	Kanlux logo and A-E energy efficiency scale			

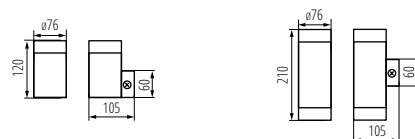

MAGRA EL-135

MAGRA EL-235

Kanlux

ZEW EL

OPRAWA ELEWACYJNA ► FACADE LUMINAIRE



ZEW EL-235J-B



ZEW EL-235U-B



ZEW EL-235J-GR



ZEW EL-235U-GR



Oprawy Kanlux ZEW doskonale nadają się do oświetlenia elewacji budynków różnego typu, a dzięki strumieniowi światła, który skierowany jest zarówno w górę jak i w dół, kreślą one na elewacji piękne, dekoracyjne akcenty świetlne. Wysoka klasa szczelności IP44 sprawia, że oprawy można montować w miejscach bezpośrednio narażonych na działanie czynników atmosferycznych.

Materiał obudowy: stop aluminium
Materiał szyby ochronnej: szkło hartowane

Kanlux ZEW luminaires are a perfect solution for illuminating facades of buildings of various types, while the light flux directed both upwards and downwards, they create one beautiful decorative light accents on the façade. Owing to the high class of tightness (IP44), the luminaires can be mounted in places directly exposed to weather conditions.

Enclosure material: aluminum alloy
Protective glass material: Tempered glass



ZEW EL-235J-B	22440	5905339224408	2 x max 35	PAR16	GU10	do nadbudowania na ścianie wall mounted	czarny black	góra i dół up and down
ZEW EL-235U-B	22441	5905339224415	2 x max 35	PAR16	GU10	do nadbudowania na ścianie wall mounted	czarny black	góra i dół up and down
ZEW EL-235J-GR	22442	5905339224422	2 x max 35	PAR16	GU10	do nadbudowania na ścianie wall mounted	szary grey	góra i dół up and down
ZEW EL-235U-GR	22443	5905339224439	2 x max 35	PAR16	GU10	do nadbudowania na ścianie wall mounted	szary grey	góra i dół up and down

[V] 220-240 AC	[Hz] 50/60	PAR16			IP 44	 0,5m		 -20+35
	 1+2,5							

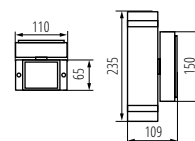

ZEW EL-235J

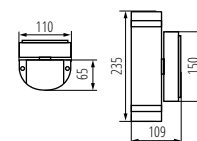

ZEW EL-235U

ELNER LED

OPRAWA ELEWACYJNA ► FACADE LUMINAIRE



ELNER LED 8W-NW-B



ELNER LED 15W-NW-B



ELNER LED 8W-NW-SE-B



ELNER LED 15W-NW-SE-B



Model	Power [W]	SKU	Beam Angle [°]	Light Output [lm]	Color Temp [K]	Material	Mounting
ELNER LED 8W-NW-B	27560	5905339275608	8	360	4000	czarny black	54
ELNER LED 15W-NW-B	27561	5905339275615	15	660	4000	czarny black	54
ELNER LED 8W-NW-SE-B	27562	5905339275622	8	360	4000	czarny black	44 PIR
ELNER LED 15W-NW-SE-B	27563	5905339275639	15	660	4000	czarny black	44 PIR

[V]	[Hz]	[°]	[h]	[lm]	Ra	SMD	IP	SENSOR	0,5m
220-240 AC	50/60	120	≥20000	30000	≥80				
[°C]	[mm]	CE	EAC	Kanlux					
-20+40	0,75+1,5								

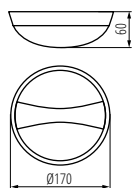

ELNER LED 8W

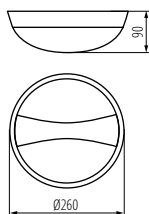

ELNER LED 15W

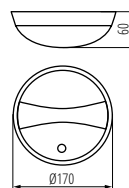

ELNER LED 8W-SE

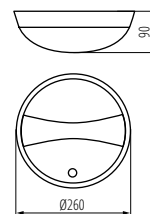

ELNER LED 15W-SE



Oprawy hermetyczne Kanlux ELNER LED to nieodłączne oświetlenie elewacji, czy miejsc o podwyższonej wilgotności. Ponadto Kanlux ELNER LED to atrakcyjny wygląd w klasycznej kolorystyce i mleczny klosz równomiernie rozpraszający światło. Dodatkowym atutem opraw jest szybki i łatwy montaż, a także jej trwałość.

Materiał obudowy: tworzywo sztuczne
Materiał klosza: tworzywo sztuczne

The hermetic Kanlux ELNER LED fixtures are an indispensable source of lighting for facades, or places with increased humidity. Moreover, Kanlux ELNER LED has an attractive appearance with classic colours and a milky lampshade which evenly distributes light. An additional advantage of the fixture is quick and easy assembly, as well as its durability..

Enclosure material: plastic
Lampshade material: plastic

Kanlux

REKA LED

OPRAWA ELEWACYJNA ► FACADE LUMINAIRE

NEW



REKA LED EL 7W-L-GR



REKA LED EL 7W-O-GR



REKA LED EL 7W-L-W



REKA LED EL 7W-O-W



Podstawową zaletą Kanlux REKA LED jest ciekawy wizualnie efekt świetlny, który lampa tworzy po włączeniu, a także dowolna regulacja strumienia światła za pomocą kłap maskujących. Kanlux REKA LED znajdzie zastosowanie przy oświetleniu elewacji budynków.

Regulacja kąta świecenia

Materiał obudowy: stop aluminium

The main advantage of the Kanlux REKA LED is an interesting visual effect, which the lamp creates when switched on, as well as the free luminous flux adjustment by means of masking flaps. The Kanlux REKA LED can be used for building-facade lighting.

Beam-angle adjustment

Enclosure material: aluminum alloy



Model	Code	Power [W]	Beam angle [°]	Light output [lm]	Temp. [K]	Mounting	Material	Beam direction
REKA LED EL 7W-L-GR	28990	5905339289902	7	max 360	4000	do nadbudowania na ścianie wall mounted	grafitowy graphite	góra i dół up and down
REKA LED EL 7W-O-GR	28991	5905339289919	7	max 380	4000	do nadbudowania na ścianie wall mounted	grafitowy graphite	góra i dół up and down
REKA LED EL 7W-L-W	28992	5905339289926	7	max 500	4000	do nadbudowania na ścianie wall mounted	biały white	góra i dół up and down
REKA LED EL 7W-O-W	28993	5905339289933	7	max 510	4000	do nadbudowania na ścianie wall mounted	biały white	góra i dół up and down

[V] 220-240 AC	[Hz] 50/60	[°] max 90	[h] ≥20000	[h] 30000	[lm] ≤ 6x Nachdam	Ra ≥80	COB	IP 54
0,5m	-15+35				1		CE EAC	Kanlux

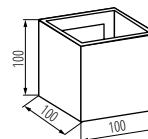

REKA LED EL-L

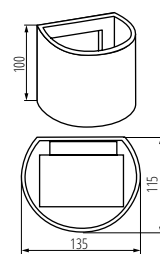

REKA LED EL-W

Kanlux BISO LED

OPRAWA ELEWACYJNA ► FACADE LUMINAIRE

NEW



BISO LED EL 8W-GR



BISO LED EL 8W-W



54IP

LED
technology

Kanlux BISO to oprawy elewacyjne, które charakteryzują się prostym i atrakcyjnym designem. Mogą być stosowane jako oprawa do wnętrz (posiadają odpowiedni współczynnik CRI), jednocześnie można stosować je na elewacjach budynku (IP54). W oprawie Kanlux BISO światło padające z modułu LED jest miękko rozpraszane na elewacji i tylnej części oprawy.

Materiał obudowy: stop aluminium

Materiał szyby ochronnej: tworzywo sztuczne

Kanlux BISO are facade fittings characterized by simple and attractive design. They can be used as a fitting for interiors (they have an appropriate CRI coefficient), at the same time they can be used on building facades (IP54). In Kanlux BISO holder light falling from the LED module is softly diffused on facade and rear part of the holder.

Enclosure material: aluminum alloy

Protective glass material: plastic



BISO LED EL 8W-GR	29260	5905339292605	8	140	4000	do nadbudowania na ścianie wall mounted	grafitowy graphite
BISO LED EL 8W-W	29261	5905339292612	8	375	4000	do nadbudowania na ścianie wall mounted	biały white

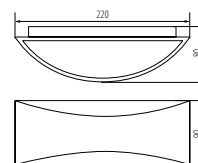

BISO LED EL 8W

[V]	[Hz]	[h]	[lm]	Ra	COB	[m]	CE	ERAC	[m]
220-240 AC	50/60	≥25000	25000	≥80	COB	1,5÷2,5	CE	ERAC	1,5÷2,5
IP 54	0,5m	-15÷40	≤60/No flicker	≥80	COB	1,5÷2,5	CE	ERAC	1,5÷2,5

Kanlux FORRO LED

OPRAWA ELEWACYJNA ► FACADE LUMINAIRE

NEW



FORRO LED EL 8W-GR



FORRO LED EL 8W-W



54IP

LED
technology

Kanlux FORRO to oprawy elewacyjne, które charakteryzują się prostym i atrakcyjnym designem. Mogą być stosowane jako oprawa do wnętrz (posiadają odpowiedni współczynnik CRI), jednocześnie można stosować je na elewacjach budynku (IP54). W Kanlux FORRO kierunek padania światła jest zwrócony na elewację, tworząc świetlny otok wokół oprawy.

Materiał obudowy: stop aluminium

Materiał szyby ochronnej: tworzywo sztuczne

Kanlux FORRO are facade fittings characterized by simple and attractive design. They can be used as a fitting for interiors (they have an appropriate CRI coefficient), at the same time they can be used on building facades (IP54). In Kanlux FORRO light is directed towards facade, creating a light rim around the holder.

Enclosure material: aluminum alloy

Protective glass material: plastic



FORRO LED EL 8W-GR	29250	5905339292506	8	330	4000	do nadbudowania na ścianie wall mounted	grafitowy graphite
FORRO LED EL 8W-W	29251	5905339292513	8	480	4000	do nadbudowania na ścianie wall mounted	biały white

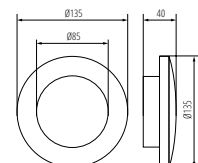

FORRO LED EL 8W

[V]	[Hz]	[h]	[lm]	Ra	SMD	[m]	CE	ERAC	[m]
220-240 AC	50/60	≥25000	25000	≥80	SMD	1,5÷2,5	CE	ERAC	1,5÷2,5
IP 54	0,5m	-15÷40	≤60/No flicker	≥80	SMD	1,5÷2,5	CE	ERAC	1,5÷2,5

Kanlux

GARTO LED

OPRAWA ELEWACYJNA ► FACADE LUMINAIRE

NEW



GARTO LED EL 8W-GR



GARTO LED EL 8W-W



Kanlux GARTO to oprawy elewacyjne, które charakteryzują się prostym i atrakcyjnym designem. Mogą być stosowane jako oprawa do wnętrz (posiadają odpowiedni współczynnik CRI), jednocześnie można stosować je na elewacjach budynku (IP54). W oprawie Kanlux GARTO światło na elewację pada od góry i od dołu będąc równomiernie rozproszone w obu kierunkach.

Materiał obudowy: stop aluminium
Materiał szyby ochronnej: tworzywo sztuczne

Kanlux GARTO are facade fittings characterized by simple and attractive design. They can be used as a fitting for interiors (they have an appropriate CRI coefficient), at the same time they can be used on building facades (IP54). In Kanlux GARTO holder light falls on facade from upwards and from downwards being evenly diffused in both directions.

Enclosure material: aluminum alloy
Protective glass material: plastic



GARTO LED EL 8W-GR	29270	5905339292704	8	300	4000	do nadbudowania na ścianie wall mounted	grafitowy graphite
GARTO LED EL 8W-W	29271	5905339292711	8	350	4000	do nadbudowania na ścianie wall mounted	biały white

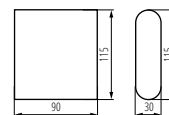

GARTO LED EL 8W

[V]	[Hz]	⚡	⌚	⊕	Ra	⊙	⚡	⊕	⊕
220-240 AC	50/60	≥25000	25000	ellipse ≤ 6x MacAdam	≥80	SMD			
IP 54	0,5m	🏠	🌡️	➡️	📏	CE	ERAC	Kanlux	
			-15+40		1,5+2,5			A A A A A A A A	

Kanlux

CROTO LED

OPRAWA NAŚCIENNA ► SURFACE-MOUNTED LIGHT FITTING



CROTO LED-GR-L



Kanlux CROTO to oprawa natynkowa w grafitowym kolorze, cechująca się nowoczesnym wzornictwem i energooszczędnością. Dzięki specyficznemu kształtowi panelu frontowego wydaje się, iż oprawa płasko przylega do ściany. Oprawa doskonale spełnia swoją funkcję jako oświetlenie dekoracyjne, lub doświetlające schody czy też ogólną przestrzeń wokół budynku.

Materiał obudowy: tworzywo sztuczne
Materiał szyby ochronnej: PC

Kanlux CROTO is a façade luminaire in graphite colour, characterised by modern design and energy efficiency. Due to the specific shape of the front panel, the luminaire seems to lie flat against the wall. The luminaire perfectly fulfills its function as a decorative lighting, additional stair lighting or illumination of spaces around buildings.

Enclosure material: plastic
Protective glass material: PC

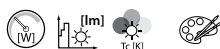

CROTO LED-GR-L	22770	5905339227706	1,1	30	6500	szary grey
----------------	-------	---------------	-----	----	------	--------------

[V]	[Hz]	⚡	⌚	⊕	Ra	⊙	⚡	⊕	⊕
220-240 AC	50/60	≥15000	20000	ellipse ≤ 6x MacAdam	≥80	SMD			
IP 65	0,2m	🏠	🌡️	➡️	📏	CE	ERAC	Kanlux	
			-20+35		0,5+1,5			A A A A A A A A	

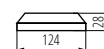
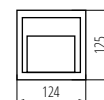

CROTO LED-GR-L

Kanlux

DORA LED

OPRAWA DO WBUDOWANIA ► RECESSED LIGHT FITTING



DORA LED-J01

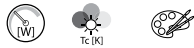

DORA LED-J01 | **04680** | 5905339046802 | 1,2 | 3800-4200 | szary | grey

[V]	[Hz]	(h)				IP	☰
220-240 AC	50/60	20000				65	0,2m
	[°C]				CE	ERC	
	-20÷35			0,75			

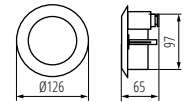

DORA LED-J01

LED
techno
logy

65IP

Kanlux LICA LED to oprawa do wbudowania z kategorii oświetlenia akcentowego. Można ją montować zarówno wewnątrz, jak i na zewnątrz budynków (IP54). Jest to idealne rozwiązanie do dekoracyjnego podświetlania schodów lub podestów.

możliwość zasilania przelotowego do 5 opraw
w zestawie plastikowa puszka do zabudowy

Kanlux LICA LED is a luminaire for embedding, classified as accent lighting. It can be installed both indoors and outdoors (IP54). A perfect choice for decorative lighting of stairs and platforms.

optional feed-through power supply for up to 5 light fixtures
included plastic junction box for installation

Kanlux

LICA LED

OPRAWA DO WBUDOWANIA ► RECESSED LIGHT FITTING



LICA LED-J04A



LICA LED-J04A | **04684** | 5905339046840 | 1,5 | 3800-4200 | szary | grey

[V]	[Hz]	(h)				IP	☰
220-240 AC	50/60	20000				65	0,2m
	[°C]				CE	ERC	
	-20÷35			0,75			

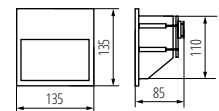

LICA LED-J04A

Kanlux LINDA LED

OPRAWA DO WBUDOWANIA ► RECESSED LIGHT FITTING



LINDA LED-J02

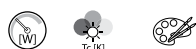

LINDA LED-J02 | 04681 | 5905339046819 | 1,2 | 3800-4200 | szary | grey

[V] 220-240 AC	[Hz] 50/60	[h] 20000	Tc (K) 3800-4200	[lm] 0,75	CE	ERAC	IP 65	0,2m
[°C] -20+35	[lm] 0,75	[mm] 0,75	CE	ERAC	Kanlux			

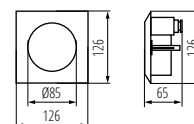

LINDA LED-J02

Kanlux ONSTAR LED

OPRAWA NAŚCIENNA ► SURFACE-MOUNTED LIGHT FITTING



ONSTAR LED-GR

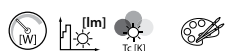

ONSTAR LED-GR | 22760 | 5905339227607 | 1,7 | 60 | 6500 | szary | grey

[V] 220-240 AC	[Hz] 50/60	[h] ≥15000	[h] 20000	Ra ≥80	SMD	[lm] 0,5+1,5	CE	ERAC	IP 65
[°C] -20+35	[lm] 0,5+1,5	[mm] 0,5+1,5	CE	ERAC	Kanlux				

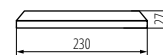
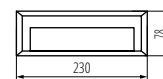

ONSTAR LED-GR



Kanlux LINDA LED to oprawa do wbudowania z kategorii oświetlenia akcentowego. Można ją montować zarówno wewnątrz, jak i na zewnątrz budynków (IP54). Jest to idealne rozwiązanie do dekoracyjnego podświetlania schodów lub podestów.

możliwość zasilania przelotowego do 5 opraw
w zestawie plastikowa puszka do zabudowy

Kanlux LINDA LED is a luminaire for embedding, classified as accent lighting. It can be installed both indoors and outdoors (IP54). A perfect choice for decorative lighting of stairs and platforms.

optional feed-through power supply for up to 5 light fixtures
included plastic junction box for installation



Kanlux ONSTAR to oprawa natynkowa w grafitowym kolorze, cechująca się nowoczesnym wzornictwem i energooszczędnością. Dzięki specyficznemu kształtowi panelu frontowego wydaje się, iż oprawa płasko przylega do ściany. Oprawa doskonale spełnia swoją funkcję jako oświetlenie dekoracyjne lub doświetlające schody czy też ogólną przestrzeń wokół budynku.

Materiał obudowy: tworzywo sztuczne
Materiał szyby ochronnej: PC

Kanlux ONSTAR is a facade luminaire in graphite colour, characterised by modern design and energy efficiency. Due to the specific shape of the front panel, the luminaire seems to lie flat against the wall. The luminaire perfectly fulfills its function as a decorative lighting, additional stair lighting or illumination of spaces around buildings.

Enclosure material: plastic
Protective glass material: PC

TAXI SMD

OPRAWA DO WBUDOWANIA ► RECESSED LIGHT FITTING



TAXI SMD L C/M-NW



TAXI SMD P C/M-NW



Kanlux TAXI SMD to ledowa oprawa akcentowa. Można ją montować zarówno wewnątrz, jak i na zewnątrz budynków (IP54). Jest to idealne rozwiązanie do dekoracyjnego podświetlania schodów lub podestów.

Materiał obudowy: metal
Materiał szyby ochronnej: szkło
Materiał panelu/ramki: stal nierdzewna

Kanlux TAXI SMD is a LED accent luminaire. It can be installed both indoors and outdoors (IP54). A perfect choice for decorative lighting of stairs and platforms.

Enclosure material: Metal
Protective glass material: glass
Panel/frame material: stainless steel



TAXI SMD L C/M-WW	26460	5905339264602	0,6	10	3000	chrom mat chrome matte
TAXI SMD L C/M-NW	26461	5905339264619	0,6	10	4000	chrom mat chrome matte
TAXI SMD P C/M-WW	26462	5905339264626	0,6	10	3000	chrom mat chrome matte
TAXI SMD P C/M-NW	26463	5905339264633	0,6	10	4000	chrom mat chrome matte

[V]	[Hz]	[h]	[h]	[lm]	[Ra]	[SMD]	[W]
220-240 AC	50/60	≥10000	20000	≤6x Macadam	≥80	SMD	W
[m]	[mm]	IP	[m]	[°C]	[°C]	[A]	[A]
0,22	0,75	54	0,1m	-20+35			
CE		EAC		Kanlux			

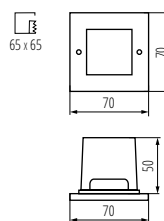

TAXI SMD L

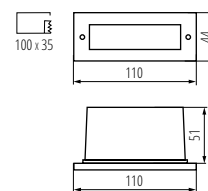

TAXI SMD P

Kanlux TURRO LED

OPRAWA DOGRUNTOWA ► IN-GROUND FIXTURE



TURRO LED 30W-NW



Kanlux TURRO LED to oprawa dogruntowa. Iluminacja fasad budynków czy elementów krajobrazu to główne zastosowanie tych opraw. Zastowane soczewki zapewniają wąski kąt świecenia, przez co oprawa idealnie oświetla powierzchnie otwarte, ale również ściany narożne, wnęki okienne, nisze, kolumny czy maszty flagowe.

Soczewkowy układ optyczny
Materiał obudowy: stop aluminium
Materiał szyby ochronnej: szkło hartowane

Kanlux TURRO LED is an in-ground fixture. Illumination of building façades or landscape elements is the main application of these fixtures. The lenses used here provide a narrow beam angle, so that the fixture perfectly illuminates open areas, but also corner walls, window recesses, niches, columns or flag poles.

Optical lens system
Enclosure material: aluminum alloy
Protective glass material: Tempered glass



TURRO LED 30W-NW | 18982 | 5905339189820 | 30 | 3000 | 4000 | 40 | stal nierdzewna | stainless steel

[V] 220-240 AC	[Hz] 50/60	 ≥15000	 25000	 elliptical ≤ 6x Max/diam	 Ra ≥70	 SMD	 No fire	 No open flame	 Grounding	IP 67
 1m	 House	 -25+35	 IK 10	 0,19	 1	 CE	 EAC			

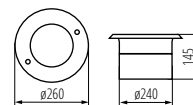

TURRO LED 30W-NW

Kanlux XARD DL

OPRAWA DOGRUNTOWA ► IN-GROUND FIXTURE



XARD DL-40



XARD DL-40 | 07195 | 5905339071958 | max 40 | A60 | E27 | stal nierdzewna | stainless steel

[V] 220-240 AC	[Hz] 50/60		 Grounding	IP 67	 0,5m	 House	 -20+35			
 IK 10	 0,22	 1	 CE	 EAC						

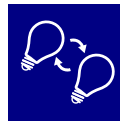

Oprawa dogruntowa Kanlux XARD charakteryzuje się największym stopniem odporności na uszkodzenia mechaniczne - tzw. „wandaloodporność” - IK10. Dodając do tego wysoki stopień szczelności IP67 otrzymujemy oprawę która jest świetnym rozwiązaniem dla oświetlenia elewacji budynków, skwerów, tarasów, parków, ścieżek, pasaży, podjazdów, schodów itp.

puszka montażowa w komplecie
całkowita długość źródła światła max 110mm
Materiał obudowy: stop aluminium
Materiał szyby ochronnej: szkło hartowane
Materiał panelu/ramki: stal nierdzewna

Kanlux XARD ground recessed luminaire is characterised by the highest level of resistance to mechanical damage - the so-called "vandal-resistance" - IK10. Add to this a high rating of tightness (IP67) and we get a luminaire which is a great solution for lighting façades of buildings, squares, terraces, parks, paths, passages, driveways, stairs, etc.

Junction box included
total light source length max 110 mm
Enclosure material: aluminum alloy
Protective glass material: Tempered glass
Panel/frame material: stainless steel

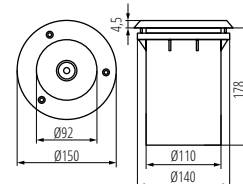

XARD DL-40

Kanlux

BERG DL

OPRAWA DOGRUNTOWA ► IN-GROUND FIXTURE



BERG DL-350



BERG DL-350	07170	5905339071705	max 35	PAR16	GU10	stal nierdzewna stainless steel
BERG DL-35L	07171	5905339071712	max 35	PAR16	GU10	stal nierdzewna stainless steel

[V] 220-240 AC	[Hz] 50/60	PAR16	GU10	IP 67	0,5m	-20+35
IK 08	1+2,5	CE	ERC	Kanlux		



Kanlux BERG to wytrzymała oprawa dogruntowa z wymiennym źródłem światła o trzonku GU10. Świetnie sprawdza się do podświetlania podjazdów, alejek, chodników itp. Wykonana jest z materiałów najwyższej jakości, dzięki czemu odporna jest na nacisk do 2 ton.

- puszka montażowa w komplecie
- możliwość łączenia przelotowego opraw
- ulepszona wymiana źródła światła
- Materiał obudowy: stal
- Materiał szyby ochronnej: szkło hartowane
- Materiał panelu/ramki: stal nierdzewna

Kanlux BERG is a durable ground-recessed luminaire using a replaceable light source with an GU10 screw. It works great in illumination of driveways, alleys, sidewalks etc. It is manufactured of best quality materials owing to which can resist pressure up to 2 tons.

- junction box included
- optional pass-through connection of light fixtures
- easier light source replacement
- Enclosure material: steel
- Protective glass material: tempered glass
- Panel/frame material: stainless steel

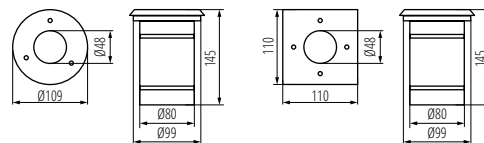

BERG DL-350

BERG DL-35L

Kanlux

GORDO LED14

OPRAWA DOGRUNTOWA ► IN-GROUND FIXTURE



GORDO LED14 SMD-0



GORDO LED14 SMD-0	22050	5905339220509	0,7	6500	stal nierdzewna stainless steel
GORDO LED14 SMD-L	22051	5905339220516	0,7	6500	stal nierdzewna stainless steel

[V] 220-240 AC	[Hz] 50/60	≥10000	20000	Ra ≥70	SMD	IP 66
0,1m	-25+35	0,3	1	CE	ERC	Kanlux



Kanlux GORDO LED14 to oprawa najazdowa ze zintegrowanym źródłem światła LED przeznaczona do wbudowania w podłoże. Wykonana jest z materiałów najwyższej jakości, dzięki czemu odporna jest na nacisk do 2 ton.

- puszka montażowa w komplecie
- Kanlux GORDO LED14 is an overrun luminaire with an integrated LED light source for embedding into the ground. It is manufactured of best quality materials owing to which can resist pressure up to 2 tons.
- Junction box included

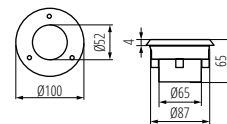

GORDO LED14 SMD-0

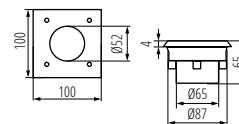

GORDO LED14 SMD-L

Kanlux MORO DL

OPRAWA DOGRUNTOWA ► IN-GROUND FIXTURE



MORO DL-35



MORO DL-35 | **04870** | 5905339048707 | max 35 | PAR16 | GU10 | stal nierdzewna | stainless steel

[VI]	[Hz]	Light bulb icon	Ground symbol	IP	Light fixture icon	Temperature icon	IK
220-240 AC	50/60			67	0,5m	-20+35	08
Light fixture icon	Dimensions icon	CE	EAC	Kanlux logo			
	0,75+1,5			A B C D E			

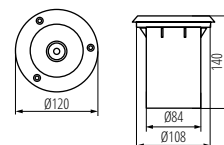

MORO DL-35

Kanlux ROGER DL

OPRAWA DOGRUNTOWA ► IN-GROUND FIXTURE



ROGER DL-LED12

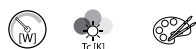

ROGER DL-LED12 | **07280** | 5905339072801 | 1 | 6000-6500 | szary | grey
ROGER DL-2LED6 | **07281** | 5905339072818 | 1 | 6000-6500 | szary | grey

[VI]	[Hz]	[h]	Light bulb icon	Ground symbol	IP	Light fixture icon	IK
220-240 AC	50/60	20000			66	0,1m	09
Temperature icon	Light fixture icon	Dimensions icon	Dimensions icon	CE	EAC	Kanlux logo	
-20+35		0,3	0,75	A B C D E			



Kanlux MORO DL to wytrzymała oprawa dogruntowa na wymienne źródła światła o trzonku GU10, którą wykorzystuje się do podświetlania podjazdów, alejek, chodników itp. Wykonana jest z materiałów najwyższej jakości dzięki czemu odporna jest na nacisk 20kN.

puszka montażowa w komplecie
do oprawy dedykowany jest przewód o średnicy max 5,5mm
Materiał obudowy: stop aluminium
Materiał szyby ochronnej: szkło hartowane
Materiał panelu/ramki: stal nierdzewna

Kanlux MORO DL is a durable ground-recessed luminaire using replaceable light sources with a GU10 screw used to illuminate driveways, alleys, sidewalks etc. It is manufactured of highest quality materials owing to which can resist pressure of 20kN.

Junction box included
the light fixture is provided with a dedicated cable of max 5.5 mm in diameter
Enclosure material: aluminum alloy
Protective glass material: Tempered glass
Panel/frame material: stainless steel



ROGER DL-2LED6



Kanlux ROGER DL to oprawa dogruntowa z wbudowanym modulem LED. Specyficzny kształt klosza rozprowadza światło równomiernie, co przekłada się na wyjątkowy efekt świetlny. Oprawa cechuje się wysokim stopniem szczelności IP66 i odpornością na uszkodzenia mechaniczne IK09.

puszka montażowa w komplecie
Materiał obudowy: stal
Materiał szyby ochronnej: tworzywo sztuczne
Materiał panelu/ramki: stop aluminium

Kanlux ROGER DL is a ground-recessed luminaire with a built-in LED module. The specific shape of the shade distributes light evenly, which produces a unique light effect. The luminaire has a very high rating of tightness (IP66) and resistance to mechanical damage (IK09).

Junction box included
Enclosure material: steel
Protective glass material: plastic
Panel/frame material: aluminum alloy

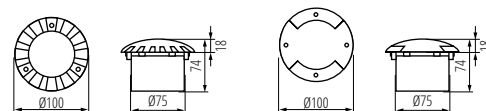

ROGER DL-LED12

ROGER DL-2LED6



INVO OP

OPRAWA ARCHITEKTONICZNA Z WYMIENNYM ŹRÓDŁEM ŚWIATEŁA
 ► ARCHITECTURAL LIGHTING WITH REPLACEABLE SOURCE OF LIGHT

NEW



INVO OP 77-L-GR



INVO OP EL-53-L-GR



INVO OP 47-L-GR



INVO OP 107-L-GR

54 IP XXL size



Kanlux INVO OP to seria zewnętrznych opraw architektonicznych. Cała rodzina składa się z słupków oraz oprawy elewacyjnej. W oprawach Kanlux INVO zastosujesz ulubioną barwę światła, ponieważ jest ona przystosowana do wymiennych źródeł o trzonku E27.

Mleczny klosz

Materiał obudowy: tworzywo sztuczne

Materiał klosza: tworzywo sztuczne

Kanlux INVO OP is a series of external architectural luminaires. The whole family is composed of posts and façade luminaires. You can use your favourite light colour in Kanlux INVO luminaires since it is adapted for replaceable sources with a E27 screw.

Milky lampshade

Enclosure material: plastic

Lampshade material: plastic



INVO OP EL-53-L-GR	29170	5905339291707	max 20	GLS/CFL/LED	E27	grafitowy graphite	do nadbudowania na ścianie wall mounted
INVO OP 47-L-GR	29171	5905339291714	max 20	GLS/CFL/LED	E27	grafitowy graphite	do nadbudowania na podłożu surface mounted
INVO OP 77-L-GR	29172	5905339291721	max 20	GLS/CFL/LED	E27	grafitowy graphite	do nadbudowania na podłożu surface mounted
INVO OP 107-L-GR	29173	5905339291738	max 20	GLS/CFL/LED	E27	grafitowy graphite	do nadbudowania na podłożu surface mounted

[V] 220-240 AC	[Hz] 50/60			IP 54		
°C -20÷35		[mm] 0,75÷1,5	0,5m			

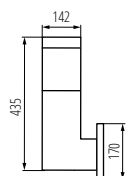

INVO OP EL-53

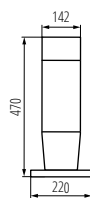

INVO OP 47

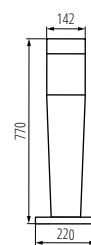

INVO OP 77

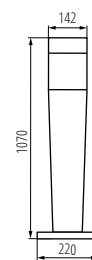

INVO OP 107

Kanlux

INVO TR

OPRAWA ARCHITEKTONICZNA Z WYMIENNYM ŹRÓDŁEM ŚWIATŁA
▶ ARCHITECTURAL LIGHTING WITH REPLACEABLE SOURCE OF LIGHT

NEW



INVO TR 77-O-GR



54IP **XXL** size



INVO TR EL-53-O-GR



INVO TR 47-O-GR



INVO TR 77-O-GR



Kanlux INVO TR to seria opraw architektonicznych z wymiennym źródłem światła GU10. Zewnętrzne słupki i oprawa elewacyjna bardzo efektywnie rozpraszają światło nie tylko w ogrodzie, ale również rozświetlają, alejki, ścieżki czy trasy spacerowe. Każda oprawa posiada miejsce na 3 źródła światła.

Transparentny klosz
Materiał obudowy: tworzywo sztuczne
Materiał klosza: tworzywo sztuczne

Kanlux INVO TR is a series of architectural luminaires with a replaceable GU10 light source. External posts and is a series of external architectural luminaires offer a very effective distribution of light in the garden and lighting of alleys, paths or walking routes. Each luminaire has a space for 3 light sources.

Transparent lampshade

Enclosure material: plastic
Lampshade material: plastic



INVO TR EL-53-O-GR	29174	5905339291745	3 x max 3,5	PAR16	GU10	grafitowy graphite	do nadbudowania na ścianie wall mounted
INVO TR 47-O-GR	29175	5905339291752	3 x max 3,5	PAR16	GU10	grafitowy graphite	do nadbudowania na podłożu surface mounted
INVO TR 77-O-GR	29176	5905339291769	3 x max 3,5	PAR16	GU10	grafitowy graphite	do nadbudowania na podłożu surface mounted
INVO TR 107-O-GR	29177	5905339291776	3 x max 3,5	PAR16	GU10	grafitowy graphite	do nadbudowania na podłożu surface mounted

[V] 220-240 AC	[Hz] 50/60	 PAR16			IP 54	
 -20+35		 0,75+2,5	 0,5m	CE	EAC	

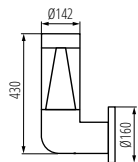

INVO TR EL-53

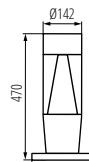

INVO TR 47

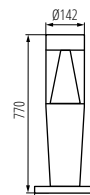

INVO TR 77

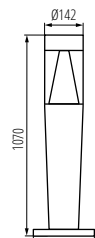

INVO TR 107

Kanlux

SEVIA LED

OPRAWA OGRODOWA LED ► LED GARDEN LIGHTING FIXTURE



SEVIA LED 26-SE



SEVIA LED 50



SEVIA LED 50-S0



SEVIA LED 80



Kanlux SEVIA to nowatorski design i czarny uniwersalny kolor, który sprawdzi się w każdej przestrzeni. Nietypowe oprawy wykonane są ze stopu aluminium i szkła.

SEVIA LED 26-SE wyposażona w czujnik ruchu/ możliwość regulacji czasu świecenia od 5s do 4 min/ maksymalny zasięg wykrywania ruchu do 3,5 m/ horizontalny kąt wykrywania ruchu 120°/ możliwość ustawienia poziomu natężenia oświetlenia otoczenia, przy którym urządzenie pracuje w zakresie 3...2000lx

Materiał obudowy: stop aluminium

Materiał szyby ochronnej: szkło

Kanlux SEVIA is an innovative design and black universal colour that will fit any space. The unusual frames are made of aluminum alloy and glass.

SEVIA LED 26-SE equipped with a motion sensor/adjustable on time from 5 s to 4 min/ maximum motion detection range up to 3.5 m/horizontal angle of motion detection 120°/ adjustable area illumination intensity at which the device operates at 3...2000lx range.

Enclosure material: aluminum alloy

Protective glass material: glass



SEVIA LED 26	23550	5905339235503	9	600	4000	do nadbudowania na ścianie wall mounted	czarny black
SEVIA LED 26-SE	23551	5905339235510	9,5	600	4000	do nadbudowania na ścianie wall mounted	czarny black
SEVIA LED 50	23552	5905339235527	9	600	4000	do nadbudowania na podłożu surface mounted	czarny black
SEVIA LED 50-S0	23553	5905339235534	9	600	4000	do nadbudowania na podłożu surface mounted	czarny black
SEVIA LED 80	23554	5905339235541	9	600	4000	do nadbudowania na podłożu surface mounted	czarny black

[V] 220-240 AC	[Hz] 50/60			
CE	EMC	Kanlux		

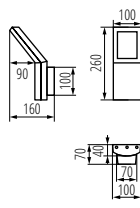

SEVIA LED 26; 26-SE

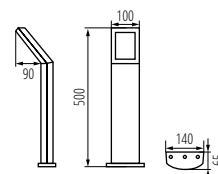

SEVIA LED 50; 50-S0

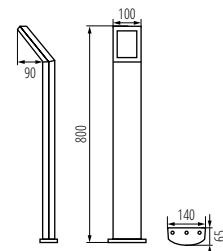

SEVIA LED 80

AGARA LED

OPRAWA OGRODOWA LED ► LED GARDEN LIGHTING FIXTURE



AGARA LED EL-14L-UP



AGARA LED EL-19I-UP



AGARA LED EL-50



AGARA LED EL-80



Kanlux AGARA LED to oprawy ogrodowe o kształcie walca wykonane ze stali nierdzewnej z wbudowanym źródłem światła. Transparentny klosz z tworzywa sztucznego efektywnie rozprasza światło, aby jak najlepiej doświetlić zakamarki ogrodu.

Materiał obudowy: stop metali niekorodujących

Materiał klosza: tworzywo sztuczne

Kanlux AGARA LED are cylinder-shaped garden luminaires made of stainless steel with a built-in light source. Transparent plastic shade effectively disperses light so as to best illuminate the nooks and crannies of the garden.

Enclosure material: non-corrosive metals alloy
Lampshade material: plastic



AGARA LED EL-14L-UP	18600	5905339186003	3	110	6500	do nadbudowania na ścianie wall mounted	stal nierdzewna stainless steel
AGARA LED EL-19I-UP	18601	5905339186010	3	110	6500	do nadbudowania na ścianie wall mounted	stal nierdzewna stainless steel
AGARA LED EL-50	18602	5905339186027	3	110	6500	do nadbudowania na podłożu surface mounted	stal nierdzewna stainless steel
AGARA LED EL-80	18604	5905339186041	3	110	6500	do nadbudowania na podłożu surface mounted	stal nierdzewna stainless steel

[V] 220-240 AC	[Hz] 50/60		 ≥15000	 20000	 ≤60° Max/klm	 Ra ≥70				IP 44
	 -20÷35		 0,5+2,5	 0,2m						

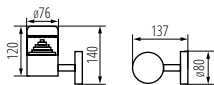

AGARA LED EL-14L-UP

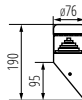

AGARA LED EL-19I-UP

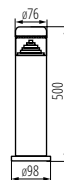

AGARA LED EL-50

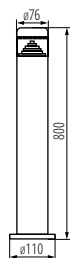

AGARA LED EL-80

Kanlux GORI

OPRAWA OGRODOWA Z WYMIENNYM ŹRÓDŁEM ŚWIATŁA
▶ GARDEN LIGHT FITTING WITH REPLACEABLE LIGHT SOURCE

NEW



GORI EL 235 D



GORI EL 135 D



GORI 50



GORI 80



GORI EL 135 D	29000	5905339290007	max 35	GU10	PAR16	antracyt anthracite	dół down
GORI EL 235 D	29001	5905339290014	2 x max 35	GU10	PAR16	antracyt anthracite	góra i dół up and down
GORI 50	29002	5905339290021	max 35	GU10	PAR16	antracyt anthracite	dół down
GORI 80	29003	5905339290038	max 35	GU10	PAR16	antracyt anthracite	dół down

[V] 220-240 AC	[Hz] 50/60	PAR16	1+2,5	0,5m	CE	EAC	IP 44	Kanlux		
°C -20+35	1+2,5	0,5m	CE	EAC	A	A	B	C	D	E

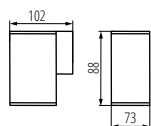

GORI EL 135

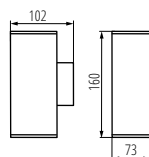

GORI EL 235

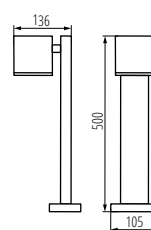

GORI 50

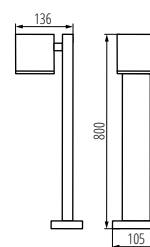

GORI 80



Oprawy ogrodowe Kanlux GORI to kompletna seria, która składa się z kinkietów i słupków. Ich kwadratowy, surowy kształt jest odpowiedzią na trendy na rynku. Wszystkie oprawy Kanlux GORI posiadają wymienne źródła światła, co daje możliwość dowolnego wyboru barwy i natężenia przydomowego światła.

Materiał obudowy: stop aluminium
Materiał szyby ochronnej: szkło hartowane

Kanlux GORI garden fixtures are a complete range, they consist of wall lamps and posts. Their square, austere shape is a direct response to market trends. All Kanlux GORI fixtures are equipped with replaceable light sources which give the possibility of a free choice of light colour and intensity around the house.

Enclosure material: aluminum alloy
Protective glass material: Tempered glass

Kanlux NOVIA

OPRAWA OGRODOWA Z WYMIENNYM ŹRÓDŁEM ŚWIATŁA
▶ GARDEN LIGHT FITTING WITH REPLACEABLE LIGHT SOURCE



NOVIA EL 220 U/D

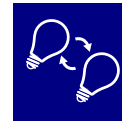

Oprawy Kanlux NOVIA znajdują swoich zwolenników wśród osób szukających oświetlenia zarówno ogólnego jak i akcentowego w swoim ogrodzie. Oprawy Kanlux NOVIA posiadają charakterystyczne „okienko” w części frontowej, które po zaświeceniu staje się dodatkowym akcentem świetlnym.

Materiał obudowy: stop aluminium
Materiał szyby ochronnej: szkło

Kanlux NOVIA luminaires will find their enthusiasts among people looking for both general and accent lighting in their gardens. Kanlux NOVIA luminaires are equipped with the characteristic “window” in the front part, which becomes an additional light accent when turned on.

Enclosure material: aluminum alloy
Protective glass material: glass



NOVIA EL 120 D



NOVIA 120 D



NOVIA 220 D



NOVIA 220 D	25660	5905339256607	2 x max 20	PAR16	GU10	do nadbudowania na podłożu surface mounted	czarny black	dół down
NOVIA 120 D	25661	5905339256614	max 20	PAR16	GU10	do nadbudowania na podłożu surface mounted	czarny black	dół down
NOVIA EL 120 D	25662	5905339256621	max 20	PAR16	GU10	do nadbudowania na ścianie wall mounted	czarny black	dół down
NOVIA EL 220 U/D	25663	5905339256638	2 x max 20	PAR16	GU10	do nadbudowania na ścianie wall mounted	czarny black	góra i dół up and down

[V] 220-240 AC	[Hz] 50/60				IP 44	
 -20+35		 0,5+2,5	 0,5m	CE	EAC	

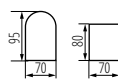

NOVIA EL 120 D

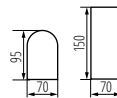

NOVIA EL 220 U-D

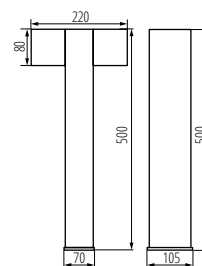

NOVIA 220 D

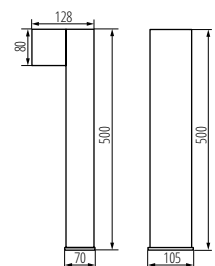

NOVIA 120 D

DARSA EL

OPRAWA OGRODOWA Z WYMIENNYM ŹRÓDŁEM ŚWIATŁA
 ► GARDEN LIGHT FITTING WITH REPLACEABLE LIGHT SOURCE



DARSA EL-135L-UP



DARSA EL-235T-UP



DARSA EL-135



DARSA EL-235T-UP



Kanlux DARSA to ponadczasowa i uniwersalna oprawa ogrodowa ze stali nierdzewnej. Wymienne źródła światła z trzonkiem GU10 w oprawie umieszczone są za osłoną z hartowanego szkła.

Materiał obudowy: stop metali niekorodujących

Materiał klosza: szkło hartowane

Materiał szyby ochronnej: szkło

Kanlux DARSA is a timeless and universal garden luminaire made of stainless steel. The replaceable light sources with GU10 screw are located in the luminaire behind a tempered glass cover.

Enclosure material: non-corrosive metals alloy

Lampshade material: Tempered glass

Protective glass material: glass



DARSA EL-135L-UP	19120	5905339191205	max 35	PAR16	GU10	do nadbudowania na ścianie wall mounted	stal nierdzewna stainless steel	dół down
DARSA EL-235T-UP	19121	5905339191212	2 x max 35	PAR16	GU10	do nadbudowania na ścianie wall mounted	stal nierdzewna stainless steel	góra i dół up and down
DARSA EL-135	19122	5905339191229	max 35	PAR16	GU10	do nadbudowania na podłożu surface mounted	stal nierdzewna stainless steel	dół down
DARSA EL-235A	19123	5905339191236	2 x max 35	PAR16	GU10	do nadbudowania na podłożu surface mounted	stal nierdzewna stainless steel	dół down

[V] 220-240 AC	[Hz] 50/60	PAR16	GU10	IP 44	CE	ERL	Kanlux
°C -20÷35	mm ² 0,5÷2,5	0,2m	A A B C D E				

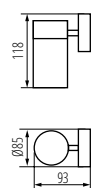

DARSA EL-135L-UP

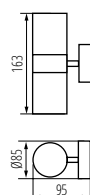

DARSA EL-235T-UP

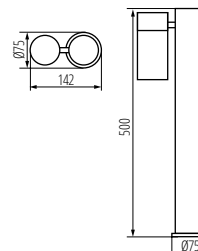

DARSA EL-135

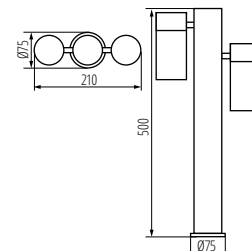

DARSA EL-235A

Kanlux SORTA

OPRAWA OGRODOWA Z WYMIENNYM ŹRÓDŁEM ŚWIATŁA
▶ GARDEN LIGHT FITTING WITH REPLACEABLE LIGHT SOURCE



SORTA 16L-UP-SE



SORTA 16L-UP



SORTA 30I-UP



SORTA 50



SORTA 80



SORTA 16L-UP	25680	5905339256805	max 20	GLS/CFL/LED	E27	do nadbudowania na ścianie wall mounted	czarny black
SORTA 16L-UP-SE	25681	5905339256812	max 20	GLS/CFL/LED	E27	do nadbudowania na ścianie wall mounted	czarny black
SORTA 30I-UP	25682	5905339256829	max 20	GLS/CFL/LED	E27	do nadbudowania na ścianie wall mounted	czarny black
SORTA 50	25683	5905339256836	max 20	GLS/CFL/LED	E27	do nadbudowania na podłożu surface mounted	czarny black
SORTA 80	25684	5905339256843	max 20	GLS/CFL/LED	E27	do nadbudowania na podłożu surface mounted	czarny black

[V] 220-240 AC	[Hz] 50/60			IP 44			Kanlux A+ A B C D E
0,5÷2,5	0,2m						

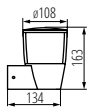

SORTA 16L-UP

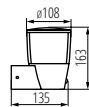

SORTA 16L-UP-SE

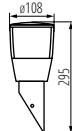

SORTA 30I-UP

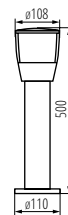

SORTA 50

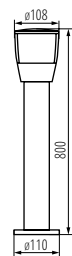

SORTA 80

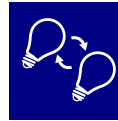

Kanlux SORTA to oprawy ogrodowe, które cechuje możliwość wymiany źródła światła, co pozwala na dostosowanie barwy i mocy oświetlenia do indywidualnych potrzeb. Oprawy zbudowane są ze szkła i aluminium, a ich czarno-biała kolorystyka wpisze się niemal w każdą scenię. Dodatkowym atutem jest opalizowany klosz, który równomiernie rozprasza światło.

max. szerokość źródła 55mm

SORTA 16L-UP-SE wyposażona w czujnik ruchu / możliwość regulacji czasu świecenia od 5s do 8 min / maksymalny zasięg wykrywania ruchu do 3m / horyzontalny kąt wykrywania ruchu 110°

Materiał obudowy: stop aluminium

Materiał klosza: PC

Kanlux SORTA are garden luminaires characterised by the option of changing the light source, which allows for adjusting the colour and power of lighting to individual needs. The luminaires are made of glass and aluminium. Their black and white colouring matches almost every scenery. The opal lampshade that evenly disperses light is its additional asset.

max. width of source 55mm

SORTA 16L-UP-SE equipped with a motion sensor / possibility of adjusting the time of lighting from 5s to 8 min / maximum motion detection range up to 3m / horizontal angle of motion detection 110°

Enclosure material: aluminum alloy

Lampshade material: PC

Kanlux

VADRA

OPRAWA OGRODOWA Z WYMIENNYM ŹRÓDŁEM ŚWIATŁA
 ► GARDEN LIGHT FITTING WITH REPLACEABLE LIGHT SOURCE

NEW



VADRA 21L-UP-SE



VADRA 16L-UP



VADRA 50



VADRA 80



VADRA 16L-UP	29010	5905339290106	max 11	E27	GLS/CFL/LED	antracyt anthracite
VADRA 21L-UP SE	29011	5905339290113	max 11	E27	GLS/CFL/LED	antracyt anthracite
VADRA 50	29012	5905339290120	max 11	E27	GLS/CFL/LED	antracyt anthracite
VADRA 80	29013	5905339290137	max 11	E27	GLS/CFL/LED	antracyt anthracite

[V] 220-240 AC	[Hz] 50/60			IP 44		 -20+35	
 1,5+2,5		 0,2m	CE	ERL	 		

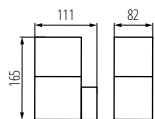

VADRA 16L

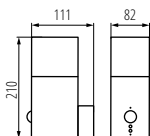

VADRA 21L

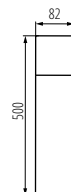

VADRA 50

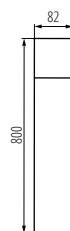

VADRA 80



Zewnętrzne oprawy oświetleniowe Kanlux VADRA przeznaczone są do montażu ściennego (kinkiety) lub na podłożu stałym (słupki). Kanlux VADRA posiadają wymienne źródła światła, co daje możliwość dowolnego wyboru barwy i natężenia przydomowego światła.

Maksymalna wysokość źródła światła 110mm
 VADRA 21L-UP-SE - oprawa z czujnikiem ruchu PIR

Materiał obudowy: stop aluminium
 Materiał klosza: tworzywo sztuczne

External Kanlux VADRA fixtures are designed for wall mounting (wall lamps) or on solid ground (posts). Kanlux VADRA are equipped with replaceable light sources which give the possibility of a free choice of light colour and intensity around the house.

Maximum light-source height 110mm

VADRA 21L-UP SE fixture with PIR motion sensor

Enclosure material: aluminum alloy
 Lampshade material: plastic



OPRAWA OGRODOWA Z WYMIENNYM ŹRÓDŁEM ŚWIATŁA
 ► GARDEN LIGHT FITTING WITH REPLACEABLE LIGHT SOURCE



RILA 23L-UP



RILA 23L-DOWN



RILA 81-PEND



RILA 30



RILA 100

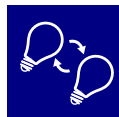

Kanlux RILA to oprawy ogrodowe z wymiennym źródłem światła o trzonku E27, które ze względu na swój oryginalny design pełnią również funkcję dekoracyjną. Dzięki zastosowaniu wysokiej jakości materiałów w postaci stopu aluminium będą nam służyć przez wiele lat.

Materiał obudowy: stop aluminium

Materiał szyby ochronnej: tworzywo sztuczne

Kanlux RILA are garden luminaires with replaceable light source with E27 screw that also have decorative function due to their original design. Owing to the use of high quality materials - an aluminum alloy, we can use them for long years.

Enclosure material: aluminum alloy

Protective glass material: plastic



RILA 23L-UP	23580	5905339235800	max 60	GLS/CFL/LED	E27	do nadbudowania na ścianie wall mounted	grafitowy graphite
RILA 23L-DOWN	23581	5905339235817	max 60	GLS/CFL/LED	E27	do nadbudowania na ścianie wall mounted	grafitowy graphite
RILA 81-PEND	23582	5905339235824	max 60	GLS/CFL/LED	E27	do nadbudowania na sufitcie ceiling mounted	grafitowy graphite
RILA 30	23583	5905339235831	max 60	GLS/CFL/LED	E27	do nadbudowania na ścianie wall mounted	grafitowy graphite
RILA 100	23584	5905339235848	max 60	GLS/CFL/LED	E27	do nadbudowania na podłożu surface mounted	grafitowy graphite

[V] 220-240 AC	[Hz] 50/60			IP 44			Kanlux G
			CE	EMC			
	0,5+2,5	0,2m					

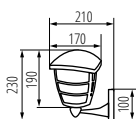

RILA 23L-UP

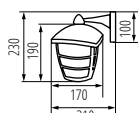

RILA 23L-DOWN

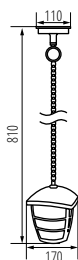

RILA 81-PEND

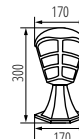

RILA 30

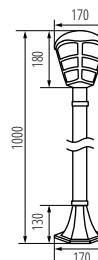

RILA 100

Kanlux

LUGEA

OPRAWA OGRODOWA Z WYMIENNYM ŹRÓDŁEM ŚWIATŁA
 ► GARDEN LIGHT FITTING WITH REPLACEABLE LIGHT SOURCE



LUGEA 28L-UP



LUGEA 31L-UP-SE



LUGEA 50



LUGEA 80



Futurystyczny design opraw Kanlux LUGEA doskonale dopasuje się do każdego ogrodu lub przestrzeni przydomowej. Stal nierdzewna oraz tworzywo sztuczne najwyższej jakości, z którego wykonano klosz oprawy, podkreślają walory ozdobne opraw Kanlux LUGEA.

LUGEA 31L-UP-SE wyposażona w czujnik ruchu/ możliwość regulacji czasu świecenia od 8s do 4,5 min/ maksymalny zasięg wykrywania ruchu do 7 m/maksymalny kąt działania czujnika ruchu wynoszący 110°/

Materiał obudowy: stop metali niekorodujących

Materiał klosza: tworzywo sztuczne

The futuristic design of Kanlux LUGEA luminaires perfectly matches any garden or backyard. Stainless steel and highest quality plastic used to manufacture the luminaire shade highlight the decorative qualities of the luminaires Kanlux LUGEA.

LUGEA 31L-UP-SE equipped with a motion sensor/adjustable on time from 8s to 4.5 min/maximum motion detection range is 7 m/maximum angle of motion detector operation is 110°

Enclosure material: non-corrosive metals alloy

Lampshade material: plastic

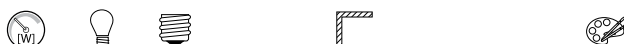

LUGEA 28L-UP	23530	5905339235305	max 60	GLS/CFL/LED	E27	do nadbudowania na ścianie wall mounted	stal nierdzewna stainless steel
LUGEA 31L-UP-SE	23531	5905339235312	max 60	GLS/CFL/LED	E27	do nadbudowania na ścianie wall mounted	stal nierdzewna stainless steel
LUGEA 50	23532	5905339235329	max 60	GLS/CFL/LED	E27	do nadbudowania na podłożu surface mounted	stal nierdzewna stainless steel
LUGEA 80	23533	5905339235336	max 60	GLS/CFL/LED	E27	do nadbudowania na podłożu surface mounted	stal nierdzewna stainless steel

[V] 220-240 AC	[Hz] 50/60			IP 44		 -20÷35
	 0,5+2,5	 0,2m	CE	ERL		

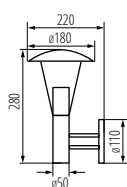

LUGEA 28L-UP

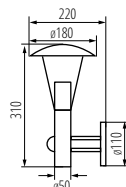

LUGEA 31L-UP-SE

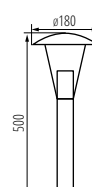

LUGEA 50

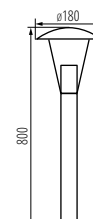

LUGEA 80

STONO

OPRAWA OGRODOWA Z WYMIENNYM ŹRÓDŁEM ŚWIATŁA
 ► GARDEN LIGHT FITTING WITH REPLACEABLE LIGHT SOURCE



STONO 50



STONO 20 N



STONO 30



STONO 40



STONO 30	24651	5905339246516	max 25	GLS/CFL/LED	E27	granit Granite
STONO 40	24652	5905339246523	max 25	GLS/CFL/LED	E27	granit Granite
STONO 50	24653	5905339246530	max 25	GLS/CFL/LED	E27	granit Granite
STONO 20 N	24654	5905339246547	max 15	GLS/CFL/LED	E27	granit Granite

[V] 220-240 AC	[Hz] 50/60			IP 65		 -20+35	
	 3	 1	 0,2m	CE	EAC		



65IP

MODERN
design



Oprawy ogrodowe Kanlux STONO to imitujące kamienie świetlne kule o średnicach od 20 do 50 cm. Idealnie wkomponują się w miejsca skalniaków czy w otoczenie krzewów. Każda z nich wyposażona jest w podstawę pozwalającą osadzić oprawę w gruncie.

Materiał obudowy: ABS
 Materiał klosza: PE

Garden luminaires Kanlux STONO are light balls imitating stones, available with diameters from 20 to 50 cm. They blend perfectly in rockeries or bushes. Each of them is equipped with a base allowing for fitting the luminaire in the ground.

Enclosure material: ABS
 Lampshade material: PE

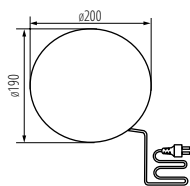

STONO 20 N

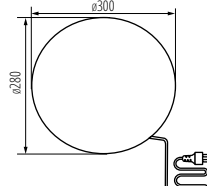

STONO 30

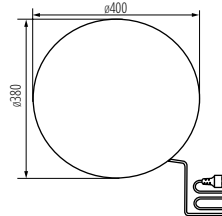

STONO 40

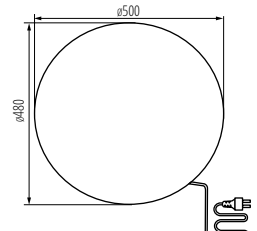

STONO 50



IDAVA

OPRAWA OGRODOWA Z WYMIENNYM ŹRÓDŁEM ŚWIATŁA
 ► GARDEN LIGHT FITTING WITH REPLACEABLE LIGHT SOURCE



IDAVA 25



IDAVA 25



IDAVA 35



IDAVA 47



IDAVA 25	23510	5905339235107	25	GLS/CFL/LED	E27	biały white
IDAVA 35	23511	5905339235114	40	GLS/CFL/LED	E27	biały white
IDAVA 47	23512	5905339235121	40	GLS/CFL/LED	E27	biały white

[V] 220-240 AC	[Hz] 50/60			IP 44		 -10+35	
	 3	 1	 0,2m	CE	ERC		

AKCESORIA ► ACCESSORIES

GL-IDAVA PS LS 25	23513	5905339235138	Klosz do oprawy IDAVA 25 / Shade for IDAVA 25 fitting
GL-IDAVA PS LS 35	23514	5905339235145	Klosz do oprawy IDAVA 35 / Shade for IDAVA 35 fitting
GL-IDAVA PS LS 47	23515	5905339235152	Klosz do oprawy IDAVA 47 / Shade for IDAVA 47 fitting
IDAVA SPIKE	23516	5905339235169	Podstawa do oprawy IDAVA / Base for IDAVA fitting



Niebanalna, a jednocześnie prosta w swej formie oprawa dogruntowa Kanlux IDAVA to idealny sposób na stworzenie jasnych przestrzeni w ogrodzie. Oprawy te cechuje wysoki stopień szczelności, a jej konstrukcja oraz tworzywo sztuczne, z którego wykonany jest klosz, dodatkowo chroni źródło światła przed wpływem czynników zewnętrznych.

w komplecie przewód 3m
 Materiał obudowy: tworzywo sztuczne
 Materiał klosza: tworzywo sztuczne

Extraordinary yet simple in its form - recessed ground lamp Kanlux IDAVA is perfect for creating bright spaces in the garden. The luminaires are characterised by a high degree of tightness, and its construction and plastic of which the shade is made, additionally protects the light source from the influence of external factors.

a cable of 3m in a set
 Enclosure material: plastic
 Lampshade material: plastic

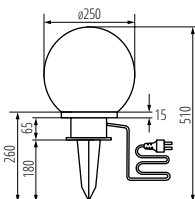

IDAVA 25

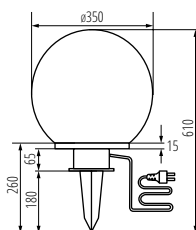

IDAVA 35

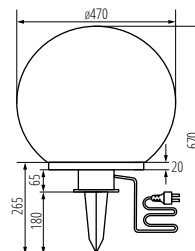

IDAVA 47

Kanlux

AKVEN LED

OPRAWA OGRODOWA Z WYMIENNYM ŹRÓDŁEM ŚWIATŁA ► GARDEN LIGHT FITTING
WITH REPLACEABLE LIGHT SOURCE



AKVEN LED



AKVEN LED | 25720 | 5905339257208 | max 35 | PAR16 | Gx5,3 | zielony | green

[W]	[Hz]	Light bulb icon	Light bulb icon	A*	[lm]	[°]	[h]	Tc [K]	ellipse ≤ 6x MacAdam	Ra	Light bulb icon	Light bulb icon
12 AC, 12 DC	50/60				370	120	≥15000	25000	3000	≥80		
IP 68	Light bulb icon	Temperature icon -20+35	Light bulb icon	Light bulb icon	Light bulb icon	Light bulb icon	Light bulb icon	Light bulb icon	Light bulb icon	Light bulb icon	Light bulb icon	Light bulb icon
					1-1,5	0,5m	CE	EAC	Kanlux logo			

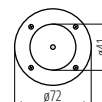
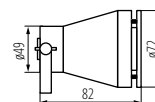

AKVEN LED



Wodoszczelna oprawa Kanlux AKVEN LED to idealne rozwiązanie do oświetlenia oczek wodnych. Wyposażona jest w wymienne źródło światła LED i przystosowana do długotrwałego zanurzenia w wodzie na głębokość do 3 metrów.

Materiał obudowy: stop aluminium
Materiał klosza: szkło
Materiał szyby ochronnej: szkło

Waterproof Kanlux AKVEN LED luminaire is a perfect solution for lighting ponds. It is equipped with a replaceable LED light source and adapted to long-term immersion in water, even 3 metres deep.

Enclosure material: aluminum alloy
Lampshade material: glass
Protective glass material: glass

Kanlux

GRIBLO LED

OPRAWA OGRODOWA LED ► LED GARDEN LIGHTING FIXTURE



GRIBLO LED SMD-NW

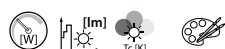

GRIBLO LED SMD-NW | 18131 | 5905339181312 | 4 | 170 | 5000 | szary | grey

[W]	[Hz]	Light bulb icon	Light bulb icon	A*	[lm]	[h]	Tc [K]	ellipse ≤ 6x MacAdam	Ra	Light bulb icon	Light bulb icon	Light bulb icon
220-240 AC	50/60				35	≥15000	30000	≤80	≥80	SMD		
IP 65	Light bulb icon	Temperature icon -15+35	Light bulb icon	Light bulb icon	Light bulb icon	Light bulb icon	Light bulb icon	Light bulb icon	Light bulb icon	Light bulb icon	Light bulb icon	Light bulb icon
					1	1	0,1m	CE	EAC	Kanlux logo		



Kanlux GRIBLO LED została wyposażona w diody LED SMD charakteryzujące się wysoką efektywnością oraz trwałością szacowaną na 30,000 h. Kanlux GRIBLO LED to oprawa dogruntowa o wysokim stopniu szczelności (IP65).

Materiał obudowy: stop aluminium
Materiał szyby ochronnej: szkło

Kanlux GRIBLO LED is equipped with SMD LEDs characterised by high energy efficiency and durability estimated at 30,000 hrs. Kanlux GRIBLO LED is a ground recessed luminaire with a high level of tightness (IP65).

Enclosure material: aluminum alloy
Protective glass material: glass

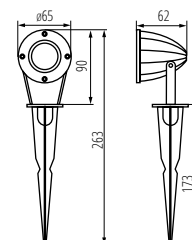

GRIBLO LED SMD-NW

Kanlux SOBI

OPRAWA SOLARNA LED ► SOLAR LED LIGHT FITTING



SOBI PV 21



Lampy ogrodowe Kanlux SOBI to stal nierdzewna, tworzywo PC i co najważniejsze, zintegrowany panel solarny. Klasyczny styl lamp i wygoda powodowana wbudowanymi akumulatorami, a tym samym niezależność od instalacji elektrycznej, to ich niewątpliwe atuty.

Materiał obudowy: stal nierdzewna
Materiał klosza: tworzywo sztuczne

Garden lamps Kanlux SOBI are made of stainless steel, PC material and, most importantly, they contain an integrated solar panel. The classic style of lamps and the comfort owing to the built-in rechargeable batteries, and thus independence from the electrical installation, are their undoubted advantages.

Enclosure material: stainless steel
Lampshade material: plastic

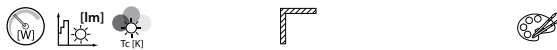

SOBI PV 21 | 25760 | 5905339257604 | 0,15 | 15 | 6500 | do nadbudowania na ścianie | wall mounted | stal nierdzewna | stainless steel

[V] 1,2 DC		 ≥15000	 15000	 ellipsoidal ≤ 60° Max/Min	 Ra ≥70		
	IP 44		 -15+40		 0,2m		

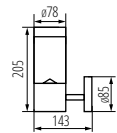

SOBI PV 21

Kanlux SOPER

OPRAWA SOLARNA LED
► SOLAR LED LIGHT FITTING



SOPER PV-SE



Lampy Kanlux SOPER to kinkiety ze zintegrowanym panelem solarnym. Nowoczesny styl lamp i niezależność od instalacji elektrycznej dzięki wbudowanym akumulatorom czyni je bardzo wygodną alternatywą dla klasycznych lamp zewnętrznych.

lampa jest wyposażona we wbudowane panele solarne
SOPER PV-SE wyposażona w czujnik ruchu
oprawa świeci przez 8 godzin po pełnym cyklu ładowania
oprawa wyposażona w akumulator: 500mAh 3.2V Ni-MH Battery
Materiał obudowy: stop metali niekorodujących
Materiał klosza: tworzywo sztuczne

Kanlux SOPER lamps are sconces with an integrated solar panel. The modern style of lamps and independence from electrical installation owing to the built-in rechargeable batteries make them a very comfortable alternative to classic outdoor lamps.

the lamp is equipped with built-in solar panels.
SOPER PV-SE provided with a movement sensor
the luminaire is lit for 8 hours after full charge
the luminaire is equipped with a battery: 500mAh 3.2V Ni-MH Battery
Enclosure material: non-corrosive metals alloy
Lampshade material: plastic

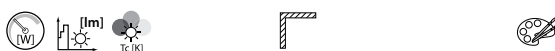

SOPER PV-SE | 25751 | 5905339257512 | 0,16 | 10 | 6500 | do nadbudowania na ścianie | wall mounted | stal nierdzewna | stainless steel

[V] 3,2 DC		 ≥15000	 15000	 ellipsoidal ≤ 60° Max/Min				IP 44
	 -20+50		 0,2m					

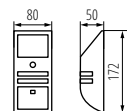

SOPER PV-SE

Kanlux SOALE

OPRAWA SOLARNA LED ► SOLAR LED LIGHT FITTING



SOALE PV 14



Oprawa Kanlux SOALE to solarna lampa LED RGB, która idealnie wkomponuje się w każdy ogród. W zależności od upodobań, lampę można przytwierdzić do ziemi, postawić na podstawie, lub umieścić ją w wodzie

Materiał obudowy: ABS

Materiał klosza: PS

Kanlux SOALE luminaire is a solar RGB LED lamp that perfectly fits in any garden. Depending on the preferences, the lamp can be fixed to the ground, put on a stand or placed in water.

Enclosure material: ABS

Lampshade material: PS

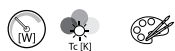

SOALE PV 14 | 25770 | 5905339257703 | 0,05 | RGB | biały | white

2 x 1,2 DC	≥15000	15000	≤ 60 Wmax/km	SMD			IP 66
			-20+50	0,2m			

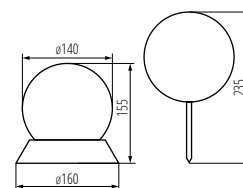

SOALE PV 14



Kanlux



OSPRZĘT ELEKTROINSTALACYJNY ELECTRICAL INSTALLATION EQUIPMENT

Zależy Ci na właściwie dobranych parametrach, wydajności i zabezpieczeniu termicznym, zwarciovym i przeciążeniowym. My damy Ci produkty przeznaczone do tych zadań. Zapewniamy komfort, niezawodność i bezpieczeństwo.

You want the properly adjusted parameters, efficiency and thermal, short-circuit and overload protection. We give you products designed for these tasks. We ensure comfort, reliability and safety.



*dane fotometryczne znajdziesz na:
photometric data you can find on:*

► [kanlux.com](https://www.kanlux.com)

ALER MINI

CZUJNIK RUCHU PIR ► PIR MOTION SENSOR



ALER MINI



ALER MINI-W	23450	5905339234506	800	do nadbudowania na ścianie wall mounted	H140/V45	10-15	PIR
-------------	--------------	---------------	-----	---	----------	-------	-----

[V] 220-240 AC	[Hz] 50/60	[VA] 800	IP 44	🏠	📐	📐	F	📏 (m) max 8
📡 H140/V45	🕒 (s) - (min) 10-15	📷 PIR	🌞 3-2000	🌡️ -20+40	📏 1+2,5	CE	ERC	

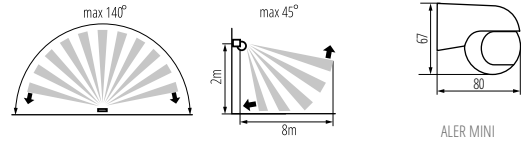

ALER MINI

Czujnik ALER MINI-W to niewielki czujnik na podczerwień o efektownym i minimalistycznym wyglądzie. Horyzontalny kąt działania czujnika wynosi 140°, a wertykalny 45°, a dzięki łatwej regulacji mechanicznej (pion 45°, poziom 90°) można dostosować go do swoich potrzeb. Posiada wysoką klasę szczelności (IP44), co sprawia, że czujnik ten można montować w miejscach bezpośrednio narażonych na działanie czynników atmosferycznych.

- maksymalny zasięg wykrywania ruchu wynoszący 8m
- maksymalny horyzontalny kąt działania czujnika ruchu wynoszący 140°
- możliwość regulacji czasu świecenia od 10s do 15min
- możliwość ustawienia poziomu natężenia oświetlenia otoczenia, przy którym urządzenie pracuje

Materiał: tworzywo sztuczne

ALER MINI-W sensor is a small infrared sensor with attractive and minimalistic design. The horizontal angle of the sensor work comes to 140°, and vertical 45°, and thanks to easy mechanical adjustment (vertical 45°, level 90°) it can be adapted to your needs. Owing to the high class of tightness (IP44), this sensor can be mounted in places directly exposed to weather conditions.

- Maximum movement detection up to 8m
 - Maximum horizontal angle of operation of the motion sensor – 140°
 - Light on time adjustable from 10s to 15min
 - Capability to set the light intensity of the environment in which the device works
- Material: plastic

ALER JQ

CZUJNIK RUCHU PIR ► PIR MOTION SENSOR



ALER JQ-30-W



ALER JQ-30-W	00460	5905339004604	1200	do nadbudowania na ścianie wall mounted	H160/V20	8-7	PIR
ALER JQ-30-B	00461	5905339004611	1200	do nadbudowania na ścianie wall mounted	H160/V20	8-7	PIR

[V] 220-240 AC	[Hz] 50/60	[VA] 1200	IP 44	🏠	📐	📐	F	📏 (m) max 12
📡 H160/V20	🕒 (s) - (min) 8-7	📷 PIR	🌞 3-2000	🌡️ -20+40	📏 1+2,5	CE	ERC	

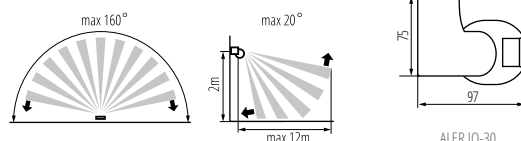

ALER JQ-30

Kanlux ALER JQ to czujnik ruchu, którego maksymalny zasięg wykrywania wynosi 12 metrów. Możemy ustawić regulację czasu świecenia jak i poziom natężenia oświetlenia, przy którym czujnik pracuje.

Kanlux ALER JQ is a motion detector whose maximum detection range comes to 12 metres. You can set adjustments of the lighting time and light intensity level at which the detector works.

Kanlux ZONA JQ

CZUJNIK RUCHU PIR ► PIR MOTION SENSOR



ZONA JQ

ZONA JQ-37-W	00464	5905339004642	1200	do nadbudowania na suficie ceiling mounted	H360\V120	15-7	PIR
--------------	-------	---------------	------	---	-----------	------	-----

[V]	[Hz]	[VA]	IP	🏠	🔧	📏	⚡	📏 [m]
220-240 AC	50\60	1200	20					max 10
H360\V120	(s) - (min)	PIR	3-2000	🌡️	📏 [mm]	CE	EAC	
	15-7		-20+40		1+2,5			

Kanlux ZONA JQ to czujnik ruchu, którego maksymalny zasięg wykrywania wynosi 10 metrów. Możemy ustawić regulację czasu świecenia jak i poziomu natężenia oświetlenia, przy którym czujnik pracuje.

maksymalny zasięg wykrywania ruchu wynoszący 10m

maksymalny poziomy kąt działania czujnika ruchu wynoszący 360°

maksymalny wertykalny kąt działania czujnika ruchu wynoszący 120°

możliwość regulacji czasu świecenia od 15s do 7min

możliwość ustawienia poziomu natężenia oświetlenia otoczenia, przy którym urządzenie pracuje

Materiał: tworzywo sztuczne

Kanlux ZONA JQ is a motion detector whose maximum detection range comes to 10 metres. You can set adjustments of the lighting time and light intensity level at which the detector works.

Maximum movement detection up to 10m

Maximum horizontal angle of operation of the motion sensor – 360°

Maximum vertical angle of operation of the motion sensor – 120°

Light on time adjustable from 15s to 7min

Capability to set the light intensity of the environment in which the device works

Material: plastic

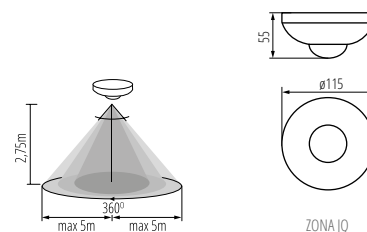

ZONA JQ

Kanlux MARID JQ

CZUJNIK RUCHU PIR ► PIR MOTION SENSOR



MARID JQ-L

MARID JQ-L	08910	5905339089106	40-500	do wbudowania w ścianę Recessed mount in the wall	H150\V30	10-7	PIR
------------	-------	---------------	--------	--	----------	------	-----

[V]	[Hz]	[VA]	IP	🏠	🔧	📏	⚡	📏 [m]
220-240 AC	50\60	40-500	20					max 12
H150\V30	(s) - (min)	PIR	3-2000	🌡️	📏 [mm]	CE	EAC	
	10-7		5+25		0,75+2,5			

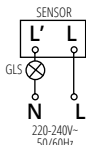

Kanlux MARID JQ to czujnik ruchu, którego maksymalny zasięg wykrywania wynosi 12 metrów. Możemy ustawić regulację czasu świecenia jak i poziomu natężenia oświetlenia, przy którym czujnik pracuje. Czujnik można uruchamiać również sygnałem dźwiękowym.

maksymalny zasięg wykrywania ruchu wynoszący 12m

maksymalny poziomy kąt działania czujnika ruchu wynoszący 150°

maksymalny wertykalny kąt działania czujnika ruchu wynoszący 30°

możliwość regulacji czasu świecenia od 10s do 7min

możliwość ustawienia poziomu natężenia oświetlenia otoczenia, przy którym urządzenie pracuje

wykrywanie ruchu 0.3...3m/s (1...10km/h)

regulacja czułości w zakresie 3...1000lx

możliwość uruchamiania czujnika sygnałem dźwiękowym w zakresie 30-90dB

przeznaczony jest tylko do odbiorników o charakterze rezystancyjnym

Materiał: tworzywo sztuczne

Kanlux MARID JQ is a motion detector whose maximum detection range comes to 12 metres. You can set adjustments of the lighting time and light intensity level at which the detector works. The detector can be activated by means of sound signal too.

Maximum movement detection up to 12m

Maximum horizontal angle of operation of the motion sensor – 150°

Maximum vertical angle of operation of the motion sensor – 30°

Light on time adjustable from 10s to 7min

Capability to set the light intensity of the environment in which the device works

Motion detection 0.3...3m/s (1...10km/h)

Sensitivity adjustment in the range of 3...1000lx

Capability to activate the sensor with a 30-90db sound signal

Designed only for resistive loads

Material: plastic

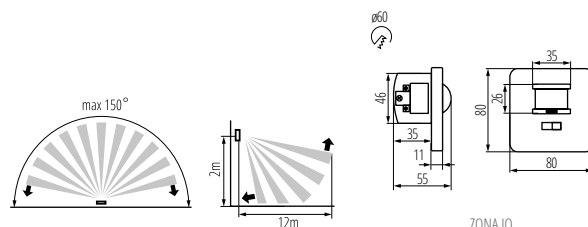

ZONA JQ

Kanlux

MERGE JQ

CZUJNIK RUCHU PIR ► PIR MOTION SENSOR



MERGE JQ-L

Kanlux MERGE JQ to czujnik ruchu, którego maksymalny zasięg wykrywania wynosi 5 metrów. Horyzontalny kąt działania czujnika wynosi 360 stopni. Możemy ustawić regulację czasu świecenia jak i poziom natężenia oświetlenia, przy którym czujnik pracuje.

- maksymalny zasięg wykrywania ruchu wynoszący 9m
- maksymalny horyzontalny kąt działania czujnika ruchu wynoszący 150°
- maksymalny wertykalny kąt działania czujnika ruchu wynoszący 60°
- możliwość regulacji czasu świecenia od 10s do 7min
- możliwość ustawienia poziomu natężenia oświetlenia otoczenia, przy którym urządzenie pracuje
- obciążenie rezystancyjne wynoszące max 1200W, obciążenie indukcyjne wynoszące max 400W
- Materiał: tworzywo sztuczne

Kanlux MERGE JQ is a motion detector whose maximum detection range comes to 5 metres. The horizontal angle of the detector work comes to 360 degrees. You can set adjustments of the lighting time and light intensity level at which the detector works.

- Maximum movement detection up to 9m
- Maximum horizontal angle of operation of the motion sensor – 150°
- Maximum vertical angle of operation of the motion sensor – 60°
- Light on time adjustable from 10s to 7min
- Capability to set the light intensity of the environment in which the device works
- Max 1200W resistive load, max. 400W inductive load
- Materiał: plastic



MERGE JQ-L | 07690 | 5905339076908 | 1200 | do wbudowania w ścianę Recessed mount in the wall | H150\V60 | 10-7 | PIR

[V]	[Hz]	[VA]	IP	House	Hand	Box	F	[m]
220-240 AC	50\60	1200	20					max 9
H150\V60	10-7	PIR	3-2000	5+25	1+2,5	CE	EAC	

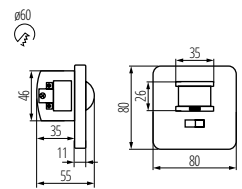
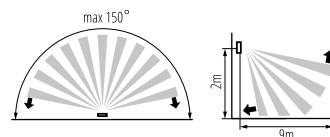
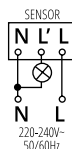

MERGE JQ-L

Kanlux

ROLF JQ

CZUJNIK RUCHU MW ► MW MOTION SENSOR



ROLF JQ

Kanlux ROLF JQ to czujnik ruchu, którego maksymalny zasięg wykrywania wynosi 8 metrów. Horyzontalny kąt działania czujnika wynosi 360 stopni. Możemy ustawić regulację czasu świecenia jak i poziom natężenia oświetlenia, przy którym czujnik pracuje.

- maksymalny zasięg wykrywania ruchu wynoszący 10m
- maksymalny horyzontalny kąt działania czujnika ruchu wynoszący 360°
- maksymalny wertykalny kąt działania czujnika ruchu wynoszący 140°
- możliwość regulacji czasu świecenia od 10s do 30min
- możliwość ustawienia poziomu natężenia oświetlenia otoczenia, przy którym urządzenie pracuje
- regulacja czułości w zakresie 2...2000lx
- wykrywanie ruchu 0.3...3m/s (1...10km/h)
- Materiał: tworzywo sztuczne

Kanlux ROLF JQ is a motion detector whose maximum detection range comes to 8 metres. The horizontal angle of the detector work comes to 360 degrees. You can set adjustments of the lighting time and light intensity level at which the detector works.

- Maximum movement detection up to 10m
- Maximum horizontal angle of operation of the motion sensor – 360°
- Maximum vertical angle of operation of the motion sensor – 140°
- Light on time adjustable from 10s to 30min
- Capability to set the light intensity of the environment in which the device works
- Sensitivity adjustment in the range of 2...2000lx
- Motion detection 0.3...3m/s (1...10km/h)
- Materiał: plastic



ROLF MINI JQ-L | 08822 | 5905339088222 | 1200 | do nadbudowania na ścianie, do nadbudowania na suficie, do nadbudowania na podłożu | wall mounted, ceiling mounted, surface mounted | H360\V140 | 10-30 | mikrofalowy microwave

[V]	[Hz]	[VA]	IP	House	Hand	Box	F	[m]
220-240 AC	50\60	1200	20					max 10
H360\V140	10-30	micro wave	2-2000	5+25	1+2,5	CE	EAC	

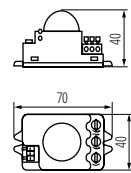
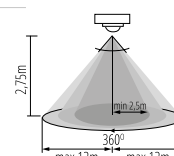

ROLF JQ

Kanlux ROLF JQ

CZUJNIK RUCHU MW ► MW MOTION SENSOR



ROLF JQ-L

Kanlux ROLF JQ to czujnik ruchu, którego maksymalny zasięg wykrywania wynosi 8 metrów. Horyzontalny kąt działania czujnika wynosi 360 stopni. Możemy ustawić regulację czasu świecenia jak i poziom natężenia oświetlenia, przy którym czujnik pracuje.

- maksymalny zasięg wykrywania ruchu wynoszący 8m
- maksymalny horyzontalny kąt działania czujnika ruchu wynoszący 360°
- maksymalny wertykalny kąt działania czujnika ruchu wynoszący 160°
- możliwość regulacji czasu świecenia od 5s do 12min
- możliwość ustawienia poziomu natężenia oświetlenia otoczenia, przy którym urządzenie pracuje
- regulacja czułości w zakresie 2...2000lx
- wykrywanie ruchu 0.3...3m/s (1...10km/h)

Materiał: tworzywo sztuczne

Kanlux ROLF JQ is a motion detector whose maximum detection range comes to 8 metres. The horizontal angle of the detector work comes to 360 degrees. You can set adjustments of the lighting time and light intensity level at which the detector works.

- Maximum movement detection up to 8m
- Maximum horizontal angle of operation of the motion sensor – 360°
- Maximum vertical angle of operation of the motion sensor – 160°
- Light on time adjustable from 5s to 12min
- Capability to set the light intensity of the environment in which the device works
- Sensitivity adjustment in the range of 2...2000lx
- Motion detection 0.3...3m/s (1...10km/h)

Material: plastic

ROLF JQ-L	08820	5905339088208	1200	do nadbudowania na ścianie, do nadbudowania na suficie, do nadbudowania na podłożu wall mounted, ceiling mounted, surface mounted	H360V160	5-12	mikrofalowy microwave
-----------	-------	---------------	------	---	----------	------	-----------------------

[V]	[Hz]	[VA]	IP	🏠	🔧	📏	⚠️	📡 [m]
220-240 AC	50V60	1200	20					max 8
📡 [m]	🕒 [s] - [min]	📡 wave	🌞 [lx]	🌡️ [°C]	📏 [mm]	CE	EAC	
H360V160	5-12	micro wave	2-2000	5+25	1+2,5			

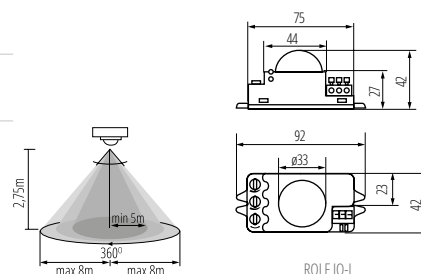

Kanlux SLICK JQ

CZUJNIK RUCHU PIR ► PIR MOTION SENSOR



SLICK JQ-L-W

Kanlux SLICK JQ to czujnik ruchu, którego maksymalny zasięg wykrywania wynosi 12 metrów. Możemy ustawić regulację czasu świecenia jak i poziom natężenia oświetlenia, przy którym czujnik pracuje.

Kanlux SLICK JQ is a motion detector whose maximum detection range comes to 12 metres. You can set adjustments of the lighting time and light intensity level at which the detector works.

SLICK JQ-L-W	08390	5905339083906	1200	do nadbudowania na ścianie wall mounted	H160V20	8-10	PIR
SLICK JQ-L-B	08391	5905339083913	1200	do nadbudowania na ścianie wall mounted	H160V20	8-10	PIR

[V]	[Hz]	[VA]	IP	🏠	🔧	📏	⚠️	📡 [m]
220-240 AC	50V60	1200	44					max 12
📡 [m]	🕒 [s] - [min]	📡 PIR	🌞 [lx]	🌡️ [°C]	📏 [mm]	CE	EAC	
H160V20	8-10	PIR	3-2000	-10÷40	1+2,5			

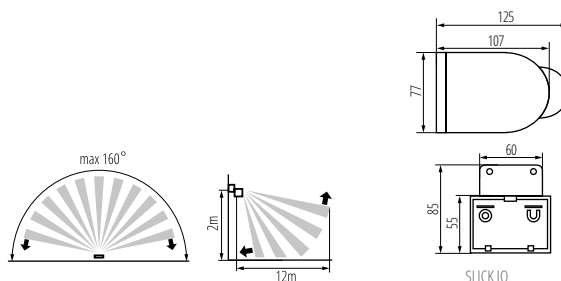

Kanlux

MERGE JQ

CZUJNIK RUCHU PIR ► PIR MOTION SENSOR



MERGE JQ-O



MERGE JQ-O | **07691** | 5905339076915 | 2000 | do wbudowania w sufit
Recessed mount in the ceiling | H360V120 | 5-6 | PIR

[V] 220-240 AC	[Hz] 50/60	[VA] 2000	IP 20				
 max 5	 H360V120	 5-6	 PIR	 3-2000	 5+25		

Kanlux MERGE JQ to czujnik ruchu, którego maksymalny zasięg wykrywania wynosi 5 metrów. Horyzontalny kąt działania czujnika wynosi 360 stopni. Możemy ustawić regulację czasu świecenia jak i poziom natężenia oświetlenia, przy którym czujnik pracuje.

- maksymalny zasięg wykrywania ruchu wynoszący 5m
- maksymalny horyzontalny kąt działania czujnika ruchu wynoszący 360°
- maksymalny wertykalny kąt działania czujnika ruchu wynoszący 120°
- możliwość regulacji czasu świecenia od 5s do 6min
- możliwość ustawienia poziomu natężenia oświetlenia otoczenia, przy którym urządzenie pracuje
- obciążenie rezystancyjne wynoszące max 2000W, obciążenie impedancyjne wynoszące max 800W

Materiał: tworzywo sztuczne

Kanlux MERGE JQ is a motion detector whose maximum detection range comes to 5 metres. The horizontal angle of the detector work comes to 360 degrees. You can set adjustments of the lighting time and light intensity level at which the detector works.

- Maximum movement detection up to 5m
 - Maximum horizontal angle of operation of the motion sensor – 360°
 - Maximum vertical angle of operation of the motion sensor – 120°
 - Light on time adjustable from 5s to 6min
 - Capability to set the light intensity of the environment in which the device works
 - Max 2000W resistive load, max. 800W inductive load
- Materiał: plastic

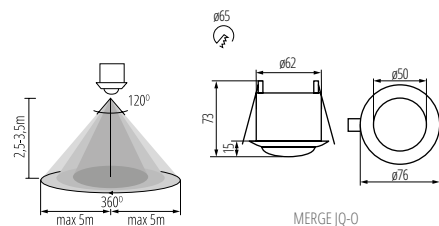

Kanlux

ROLF JQ

CZUJNIK RUCHU MW ► MW MOTION SENSOR



ROLF JQ-O



ROLF JQ-O | **08821** | 5905339088215 | 1200 | do nadbudowania na sufcie
ceiling mounted | H360V140 | 6-12 | mikrofalowy
microwave

[V] 220-240 AC	[Hz] 50/60	[VA] 1200	IP 20					 max 9
 H360V140	 6-12	 micro wave	 2-2000	 5+25	 0,75+1,5			

Kanlux ROLF JQ to czujnik ruchu, którego maksymalny zasięg wykrywania wynosi 8 metrów. Horyzontalny kąt działania czujnika wynosi 360 stopni. Możemy ustawić regulację czasu świecenia jak i poziom natężenia oświetlenia, przy którym czujnik pracuje.

- maksymalny zasięg wykrywania ruchu wynoszący 9m
 - maksymalny horyzontalny kąt działania czujnika ruchu wynoszący 360°
 - maksymalny wertykalny kąt działania czujnika ruchu wynoszący 160°
 - możliwość regulacji czasu świecenia od 6s do 12min
 - możliwość ustawienia poziomu natężenia oświetlenia otoczenia, przy którym urządzenie pracuje
 - regulacja czułości w zakresie 2...2000lx
 - wykrywanie ruchu 0.3...3m/s (1...10km/h)
- Materiał: tworzywo sztuczne

Kanlux ROLF JQ is a motion detector whose maximum detection range comes to 8 metres. The horizontal angle of the detector work comes to 360 degrees. You can set adjustments of the lighting time and light intensity level at which the detector works.

- Maximum movement detection up to 9m
 - Maximum horizontal angle of operation of the motion sensor – 360°
 - Maximum vertical angle of operation of the motion sensor – 160°
 - Light on time adjustable from 6s to 12min
 - Capability to set the light intensity of the environment in which the device works
 - Sensitivity adjustment in the range of 2...2000lx
 - Motion detection 0.3...3m/s (1...10km/h)
- Materiał: plastic

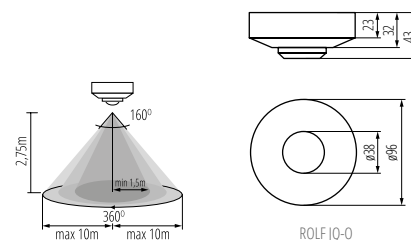

Kanlux MERGE

CZUJNIK RUCHU PIR ► PIR MOTION SENSOR



MERGE ADJ-O



Kanlux MERGE ADJ to czujnik ruchu PIR o maksymalnym zasięgu wykrywania ruchu 5m. Jego maksymalny horizontalny kąt działania to 360 stopni. W czujniku MERGE ADJ masz możliwość regulacji nastaw parametrów bez konieczności demontażu czujnika.

- maksymalny zasięg wykrywania ruchu wynoszący 5m
- maksymalny horizontalny kąt działania czujnika ruchu wynoszący 360°
- możliwość regulacji czasu świecenia od 10s do 15min
- możliwość ustawienia poziomu natężenia oświetlenia otoczenia, przy którym urządzenie pracuje
- wykrywanie ruchu 0.6-1.5m/s
- maksymalny wertykalny kąt działania czujnika ruchu wynoszący 120°
- Materiał: tworzywo sztuczne

Kanlux MERGE ADJ is a PIR motion detector with maximum motion detection range of 5m. Its maximum horizontal angle of work comes to 360 degrees. In the MERGE ADJ sensor, you can adjust settings of parameters without a necessity to disassemble the detector.

- Maximum movement detection up to 5m
- Maximum horizontal angle of operation of the motion sensor – 360°
- Light on time adjustable from 10s to 15min
- Capability to set the light intensity of the environment in which the device works
- Motion detection 0.6...1.5m/s
- Maximum vertical angle of operation of the motion sensor 120°
- Material: plastic

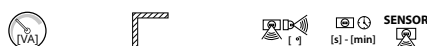

MERGE ADJ-O | 23451 | 5905339234513 | 800 | do wbudowania w sufit Recessed mount in the ceiling | H360V120 | 10-15 | PIR

[V]	[Hz]	[VA]	IP	🏠	🔧	📏	⚡	📏 [m]
220-240 AC	50/60	800	20					max 5
🔊	🕒 [s] - [min]	PIR	🌞 [lx]	🌡️ [°C]	🔧	📏 [mm]	CE	EAC
H360V120	10-15		3-2000	5+25		0,75+1,5		

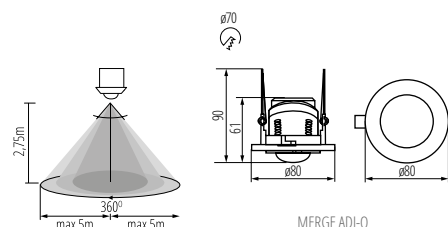

MERGE ADJ-O

Kanlux MERGE

CZUJNIK RUCHU MW ► MW MOTION SENSOR



MERGE MW-L



Czujnik Kanlux MERGE MW to estetyczne i funkcjonalne rozwiązanie. Maksymalny zasięg wykrywania wynosi 9 metrów. Możemy ustawić regulacje czasu świecenia jak i poziom natężenia oświetlenia, przy którym czujnik pracuje.

- maksymalny zasięg wykrywania ruchu wynoszący 9m
- maksymalny horizontalny kąt działania czujnika ruchu wynoszący 180°
- możliwość regulacji czasu świecenia od 10s do 12min
- możliwość ustawienia poziomu natężenia oświetlenia otoczenia, przy którym urządzenie pracuje
- wykrywanie ruchu 0.6-1.5m/s
- maksymalny wertykalny kąt działania czujnika ruchu wynoszący 180°
- Materiał: tworzywo sztuczne

Kanlux MERGE MW detector is an aesthetic and functional solution. The maximum detection range comes to 9 metres. You can set adjustments of the lighting time and light intensity level at which the detector works.

- Maximum movement detection up to 9m
- Maximum horizontal angle of operation of the motion sensor – 180°
- Light on time adjustable from 10s to 12min
- Capability to set the light intensity of the environment in which the device works
- Motion detection 0.6...1.5m/s
- Maximum vertical angle of operation of the motion sensor 180°
- Material: plastic



MERGE MW-L | 23453 | 5905339234537 | 1200 | do wbudowania w ścian Recessed mount in the wall | 180 | 10-12 | mikrofalowy microwave

[V]	[Hz]	[VA]	IP	🏠	🔧	📏	⚡	📏 [m]
220-240 AC	50/60	1200	20					max 9
🔊	🕒 [s] - [min]	micro wave	🌞 [lx]	🌡️ [°C]	🔧	📏 [mm]	CE	EAC
180	10-12		3-2000	5+25		0,75+1,5		

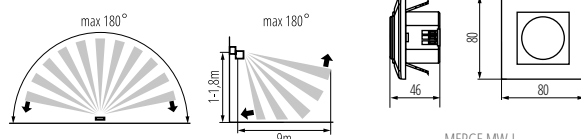

MERGE MW-L

Kanlux SENTO

CZUJNIK RUCHU PIR ► PIR MOTION SENSOR



SENTO



SENTO | 26820 | 5905339268204 | 2000 | do nadbudowania na ścianie, do nadbudowania na suficie | wall mounted, ceiling mounted | H360V120 | 10-30 | 3xPIR

[V]	[Hz]	[VA]	IP	House	Mounting	□	F	[m]
220-240 AC	50/60	2000	20					max 10
H360V120	[s] - (min)	3 x PIR	3-2000	°C	mm	CE	EAC	
	10-30			5+25	0,75+1,5			



Kanlux SENTO to czujnik elektroniczny służący do wykrywania ruchu. Jego wyjątkowość polega na zabudowaniu aż trzech detektorów podczerwi w jednej czujce. Gwarantuje to niespotykaną czułość i pozwala wychwycić nawet minimalny ruch. Kanlux SENTO, ze względu na nietypowe cechy, określamy jako czujniki obecności.

Material: tworzywo sztuczne

Kanlux SENTO is an electronic sensor for movement detection. Its exceptionality lies in the fact that as many as three infrared detectors are installed in one sensor. This guarantees an unprecedented sensitivity and allows you to capture even the slightest movement. Kanlux SENTO, due to its unusual features, is referred to as a presence detector.

Material: plastic

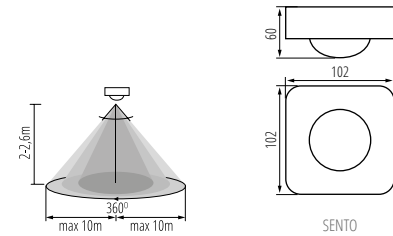

SENTO

Kanlux SENZO

CZUJNIK RUCHU PIR ► PIR MOTION SENSOR



SENZO



SENZO | 26821 | 5905339268211 | 2000 | do nadbudowania na ścianie, do nadbudowania na suficie | wall mounted, ceiling mounted | H360V120 | 10-30 | 2xPIR

[V]	[Hz]	[VA]	IP	House	Mounting	□	F	[m]
220-240 AC	50/60	2000	20					max 10
H360V120	[s] - (min)	2 x PIR	3-2000	°C	mm	CE	EAC	
	10-30			5+25	0,75+1,5			



Kanlux SENZO to czujnik ruchu PIR stosowany w systemach automatycznego załączania oświetlenia. Specjalne rozmieszczenie dwóch czujników podczerwi w Kanlux SENZO pozwala na zastosowanie go w instalacjach wysokich pomieszczeń, takich jak hale magazynowe czy produkcyjne. Jego zasięg wertykalny to aż 10 metrów.

Material: tworzywo sztuczne

Kanlux SENZO is a PIR movement sensor used in automatic lighting switching systems. The special arrangement of two infrared sensors in Kanlux SENZO allows it to be used in high room installations, such as warehouses or production halls. Its vertical range is as much as 10 meters.

Material: plastic

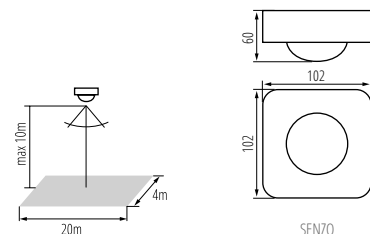

SENZO



Kanlux ZONA

CZUJNIK RUCHU PIR ► PIR MOTION SENSOR



ZONA FLAT-W



ZONA FLAT-W | 23452 | 5905339234520 | 2000 | do nadbudowania na sufitcie ceiling mounted | H360\V120 | 10-15 | PIR

[V] 220-240 AC	[Hz] 50\60	[VA] 2000	IP 20					 [m] max 8
 H360\V120	 [s] - [min] 10-15	 PIR	 [lx] 3-2000	 [°C] 5+25		 [mm] 0,75+1,5		

Kanlux ZONA FLAT to czujnik ruchu o maksymalnym zasięgu wykrywania ruchu 8m. Jego z kolei maksymalny horyzontalny kąt działania to 360 stopni. W czujniku ZONA masz możliwość regulowania czasu świecenia od 10s do 15min a także ustawienia poziomu natężenia oświetlenia otoczenia przy którym urządzenie będzie pracowało.

maksymalny zasięg wykrywania ruchu wynoszący 8m
maksymalny horyzontalny kąt działania czujnika ruchu wynoszący 360°
możliwość regulacji czasu świecenia od 10s do 15min
możliwość ustawienia poziomu natężenia oświetlenia otoczenia, przy którym urządzenie pracuje
wykrywanie ruchu 0.6-1.5m/s
maksymalny wertykalny kąt działania czujnika ruchu wynoszący 120°
Materiał: tworzywo sztuczne

Kanlux ZONA FLAT is a motion detector with maximum motion detection range of 8m. In turn, its maximum horizontal angle of work comes to 360 degrees. In the ZONA sensor, you can adjust the time of lighting from 10s to 15min as well as set the surrounding light intensity level at which the device will work.

Maximum movement detection up to 8m
Maximum horizontal angle of operation of the motion sensor – 360°
Light on time adjustable from 10s to 15min
Capability to set the light intensity of the environment in which the device works
Motion detection 0.6...1.5m/s
Maximum vertical angle of operation of the motion sensor 120°
Material: plastic

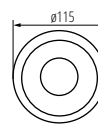
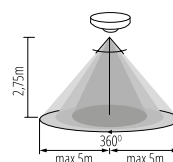

ZONA FLAT-W

Kanlux AZ-10A

PRZEKAŹNIK ZMIERZCHOWY ► DUSK RELAY



AZ-10A



AZ-10A | 22371 | 5905339223715 | biały | white | na szynę TH35 | rail TH35

[V] 220-240 AC	[Hz] 50\60	In[A] 10	[VA] 2300	 [°C] -20+40			IP 20\65			
-------------------	---------------	-------------	--------------	--------------------	--	--	-------------	--	--	--

Kanlux AZ-10A to automat zmierzchowy. Służy do włączania i wyłączania obwodów oświetlenia lub innych odbiorników elektrycznych, w zależności od poziomu natężenia oświetlenia naturalnego (dzień/noc).

Histeresa ~20Lx

Kanlux AZ-10 is a dusk and dawn light switch system. It is used for turning on and turning off lighting circuits or other electric receivers, depending on the natural light intensity level (day/night).

Hysteresis ~20Lx

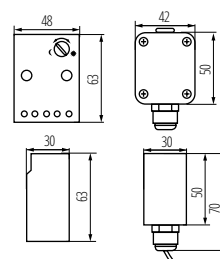

AZ-10A

Kanlux CYBER

ZEGAR/PROGRAMATOR STERUJĄCY ► CONTROL TIMER / PROGRAMMER



CYBER TM-6



CYBER TM-6 | **01016** | 5905339010162 | 3600 | 8

[V]	[Hz]	In[A]	[W]	IP	⏏	⏚	CE	EAC
220-240 AC	50\60	16(2)	3600	20				

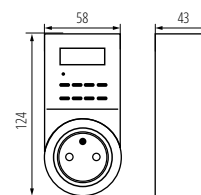

CYBER TM-6

Kanlux CYBER to adapter gniazda wtyczkowego z dobowym programatorem cyfrowym. Umożliwia zaprogramowanie włączania i wyłączenia podłączonych urządzeń w określonym czasie.

wyposażony w układ podtrzymujący pamięć
możliwość zaprogramowania max 10 włączeń/wyłączeń
programator pracuje w trybach dobowym i tygodniowym

Kanlux CYBER is an adapter of an extension socket with a 24-hour digital programmer. It makes it possible to programme turning on and turning off operations for connected devices at pre-set time.

Equipped with a memory keeping system
Up to 10 programmable on/off operations
The timer works in 24h and weekly mode

Kanlux STER TS-MF

ZEGAR/PROGRAMATOR STERUJĄCY ► CONTROL TIMER / PROGRAMMER



STER TS-MF1



STER TS-MF1 | **01001** | 5905339010018 | 3500 | 1

[V]	[Hz]	In[A]	[W]	IP	⏏	⏚	CE	EAC
220-240 AC	50\60	16(2)	3500	20				

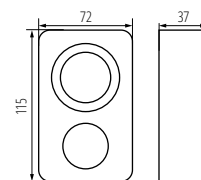

STER TS-MF1

Kanlux STER TS-MF to adapter gniazda wtyczkowego z dobowym programatorem mechanicznym. Umożliwia zaprogramowanie włączania i wyłączenia podłączonych urządzeń w określonym czasie.

programator pracuje w trybie dobowym
minimalny czas włączenia/wyłączenia wynoszący 15min
programator posiada funkcję stałego załączenia obciążenia

Kanlux STER TS-MF is an adapter of an extension socket with a 24-hour mechanical programmer. It makes it possible to programme turning on and turning off operations for connected devices at pre-set time.

The timer works in 24h mode
Minimum on/off time 15min
Timer has constant load switching capability



ADI 350 1x3W

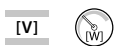

ADI 350 1x3W | 01440 | 5905339014405 | 220-240 AC | 1-3

[V]	[Hz]	CC	[W]	PRI [V]	SEC [V]	SEC [mA]	F	IP
220-240 AC	50/60		1-3	220-240	0,5-10 DC	350		20
			0,75	0,1	5+25			

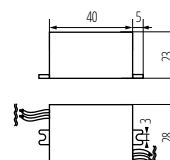

ADI 350 1x3W

Zasilacz elektroniczny o maksymalnej dopuszczalnej temperaturze obudowy 75°C i stabilizacji prądu 350mA DC. Posiada wbudowane zabezpieczenie przeciwzwarciowe i przeciwprzeciążeniowe oraz zabezpieczenie termiczne wyłączające zasilacz po przekroczeniu temperatury 110°C.

ADI 350 1-3W stabilizacja prądu 350mA DC

ADI 700 1x3W stabilizacja prądu 700mA DC

maksymalna dopuszczalna temperatura obudowy wynosząca 75°C

zabezpieczenie termiczne wyłączające zasilacz po przekroczeniu temperatury 110°C

wbudowane zabezpieczenie przeciwzwarciowe i przeciwprzeciążeniowe

Materiał: tworzywo sztuczne

Kanlux ADI electronic power supply unit - with maximum permissible temperature of casing 75°C and current stabilization 350mA DC - has an embedded protection against short circuits and against overload as well as a thermal protection turning off the power supply unit when the temperature of 110°C is exceeded.

ADI 350 1-3W current stabilization 350mA DC

ADI 700 1x3W current stabilization 700mA DC

Maximum permissible housing temperature 75°C

Thermal protection shutting down the power supply after the temperature exceeds 110°C

Built-in circuit and overload protection

Material: plastic



CIRCO LED 12VDC 0-10W



CIRCO LED 12VDC 0-10W | 24240 | 5905339242402 | 220-240 AC | 0-10
 CIRCO LED 12VDC 0-15W | 24241 | 5905339242419 | 220-240 AC | 0-15

[V]	[Hz]	CV	PRI [V]	SEC [V]	F	IP
220-240 AC	50/60		220-240	12 DC		20
			0,5	5+25		

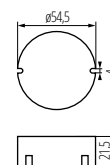

CIRCO LED 12VDC 0-10W

Kanlux CIRCO to zasilacz elektroniczny stałonapięciowy o mocy 10 lub 15 W. Służy do zasilania pasków i węży LED takich jak LED S P, LED S B.

Materiał: tworzywo sztuczne

Kanlux CIRCO is an electronic constant-voltage power supply unit with power of 10 or 15 W. It is used for powering LED belts and hoses such as LED S P.

Material: plastic

Kanlux DRIFT

ZASILACZ CV ► CV POWER SUPPLY UNIT



DRIFT LED 3-18W



DRIFT LED 0-6W

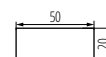
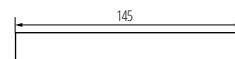

DRIFT LED 3-18W

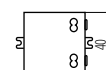

DRIFT LED 0-6W

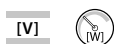

DRIFT LED 3-18W	08550	5905339085504	220-240 AC	3-18
DRIFT LED 0-6W	18040	5905339180407	220-240 AC	0-6

[V]	[Hz]	CV	PRI [V]	SEC [V]	F
220-240 AC	50/60		220-240	12 DC	
IP 20			5+25	CE	ERC

Kanlux DRIVE

ZASILACZ CV ► CV POWER SUPPLY UNIT



DRIFT LED 0-15W 12VDC



DRIFT LED 0-15W 12VDC	23860	5905339238603	220-240 AC	0-15
-----------------------	--------------	---------------	------------	------

[V]	[Hz]	CV	[W]	PRI [V]	SEC [V]	SEC (mA)	F
220-240 AC	50/60		0-15	220-240	12 DC	max 1250	
IP 20				0,75+1,5	5+25	CE	ERC

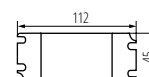

DRIFT LED 0-15W 12VDC

Kanlux DRIFT to zasilacz elektroniczny stałonapięciowy o mocach 3-18 W lub 0-6 W. Służy do zasilania pasków i węży LED takich jak LED S P, LED S B.

stabilizacja napięcia 12V DC

wbudowane zabezpieczenie przeciwzwarciowe i przeciwprzebieżeniowe

model DRIFT LED 0-6W wyposażony w przewody 0,75mm2 długość 15cm / model DRIFT LED 3-18W podłączenie przez zaciski 0,5-1,5mm2

Materiał: tworzywo sztuczne

Kanlux DRIFT is an electronic constant-voltage power supply unit with power of 3-18 W or 0-6 W. It is used for powering LED belts and hoses such as LED S P.

Voltage stabilization 12V DC

Built-in circuit and overload protection

DRIFT LED 0-6W is provided with 0.75mm2 cable 15cm length / DRIFT LED 3-18W connection via terminals 0.5-1.5mm2

Material: plastic

Kanlux DRIVE to zasilacz elektroniczny stałonapięciowy o mocy 15 W. Służy do zasilania pasków i węży LED takich jak LED S P, LED S B.

Materiał: tworzywo sztuczne

Kanlux DRIVE is an electronic constant-voltage power supply unit with power of 15 W. It is used for powering LED belts and hoses such as LED S P, LED S B.

Material: plastic

Kanlux

POWELED

ZASILACZ CV ► CV POWER SUPPLY UNIT



POWELED P 12V 30W

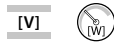

POWELED P 12V 30W	26810	5905339268105	220-240 AC	0-30
POWELED P 12V 60W	26811	5905339268112	220-240 AC	0-60

[V]	[Hz]	CV	PRI [V]	SEC [V]	F	IP
220-240 AC	50/60		220-240	12 DC		20
			0,5-1,5	5+25		

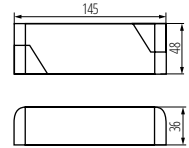

POWELED P 12V 30W

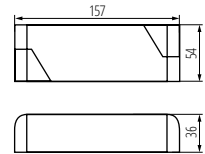

POWELED P 12V 60W

Kanlux POWELED to zasilacz elektroniczny stałonapięciowy. Służy do zasilania pasków i węży LED takich jak LED S P, LED S B.

Materiał: tworzywo sztuczne

Kanlux POWELED is an electronic constant-voltage power supply unit. It is used for powering LED belts and hoses such as LED S P, LED S B.

Materiał: plastic

Kanlux

RICO

ZASILACZ CC ► CC POWER SUPPLY UNIT



RICO LED 15-24W



RICO LED 15-24W	07301	5905339073013	5...8 x 3	700
RICO LED 10-18W	07302	5905339073020	10...18 x 1	350

[V]	[Hz]	CC	PRI [V]	F	IP	
220-240 AC	50/60		220-240		20	
		0,75-1,5	5+25			

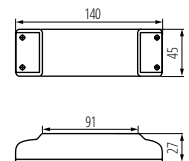

RICO LED 15-24W

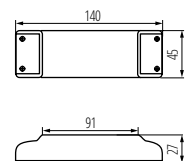

RICO LED 10-18W

Kanlux RICO LED to zasilacz elektroniczny ze stabilizacją prądu 350/700mA DC. Posiada wbudowane zabezpieczenie przeciwzwarciowe i przeciwprzeciążeniowe oraz zabezpieczenie termiczne wyłączające zasilacz po przekroczeniu temperatury 110°C.

Materiał: tworzywo sztuczne

Kanlux RICO LED is an electronic power supply unit with current stabilization of 350/700mA DC. It has an embedded protection against short circuits and against overload as well as a thermal protection turning off the power supply unit when the temperature of 110°C is exceeded.

Materiał: plastic

Kanlux SET

TRANSFORMATOR ELEKTRONICZNY SET ► SET ELECTRONIC TRANSFORMER



SET60-K

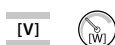

SET60-K	01425	5905339014252	220-240 AC	20-60
SET105-K	01426	5905339014269	220-240 AC	35-105
SET210-N	01433	5905339014337	220-240 AC	50-210

[V]	[Hz]	PRI [V]	SEC [V]	F	IP	House	Box
220-240 AC	50/60	220-240	11,5 AC		20		
Mounting	[mm]	Temp [°C]	CE	EMC			
	0,75-1,5	5+25					

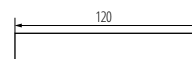

SET80LT

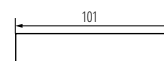

SET60-K

współczynnik mocy biernej $\cos\phi$ dla SET60-K i SET105-K wynoszący 0,99, dla SET80LT, SET150-N i SET210-N wynoszący 0,97

maksymalna dopuszczalna temperatura obudowy dla SET60-K wynosząca 80°C, dla pozostałych modeli wynosząca 85°C

zabezpieczenie termiczne wyłączające model SET80LT po przekroczeniu temperatury 100°C, modele SET150-N i SET210-N po przekroczeniu temperatury 110°C, modele SET60-K i SET105-K po przekroczeniu temperatury 120°C

wbudowane zabezpieczenie przeciwzwarciowe i przeciwprzeciążeniowe

Reactive power factor $\cos\phi$ 0.99 for SET60-K i SET105-K, for SET80LT, SET150-N and SET210-N – 0.97

Maximum permissible housing temperature 80°C for SET60-K, for other models – 85°C

Thermal protection shutting down SET80LT after the temperature exceeds 100°C, for SET150-N and SET210-N – after exceeding 110°C, for SET60-K and SET105-K – after exceeding 120°C

Built-in circuit and overload protection

Kanlux STEL

ZASILACZ CC ► CC POWER SUPPLY UNIT



STEL LED 350 8-12W

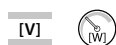

STEL LED 350 8-12W	23070	5905339230706	220-240 AC	12
STEL LED 700 6-12W	23071	5905339230713	220-240 AC	12

[V]	[Hz]	CC	[W]	PRI [V]	SEC [V]	SEC [mA]	F	IP
220-240 AC	50/60		12	220-240	22-36 DC	350/700		20
House	Box	Wiring	[mm]	[mm]	Temp [°C]	CE	EMC	
			0,5	0,13	5+25			

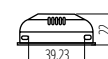
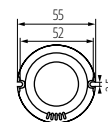

STEL LED

Kanlux STEL LED to zasilacz elektroniczny ze stabilizacją prądu 350/700mA DC. Posiada wbudowane zabezpieczenie przeciwzwarciowe i przeciwprzeciążeniowe oraz zabezpieczenie termiczne wyłączające zasilacz po przekroczeniu temperatury 110°C.

STEL LED 700: stabilizacja prądu 700mA DC

STEL LED 350: stabilizacja prądu 350mA DC

Materiał: tworzywo sztuczne

Kanlux STEL LED is an electronic power supply unit with current stabilization of 350/700mA DC. It has an embedded protection against short circuits and against overload as well as a thermal protection turning off the power supply unit when the temperature of 110°C is exceeded.

STEL LED 700: current stabilization 700mA DC

STEL LED 350: current stabilization 350mA DC

Material: plastic

Kanlux TRETO

ZASILACZ CV ► CV POWER SUPPLY UNIT



TRETO LED 30W

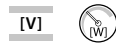

TRETO LED 30W | 07800 | 5905339078001 | 220-240 AC | 0-30

[V] 220-240 AC	[Hz] 50/60	CV	[W] 0-30	PRI [V] 220-240	SEC [V] 12 DC	SEC [mA] max 2500	F
IP 66				[m] 0,2	 -20+50	CE	EAC

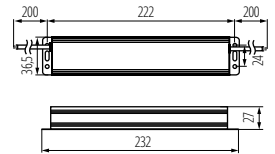

TRETO LED 30W

Kanlux DIMGO

ŚCIEMNIACZ LED ► DIMMER LED

NEW



DIMGO 105

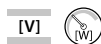

DimGO 105 | 28830 | 5905339288301 | 230 AC | 105

[V] 230 AC	[Hz] 50/60	[W] 8-105	[W] 105		IP 20	 5+25			CE	EAC
---------------	---------------	--------------	------------	--	----------	----------	--	--	----	-----

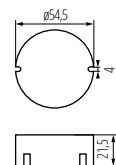

DIMGO 105

Kanlux TRETO to zasilacz elektroniczny stałonapięciowy o mocy 30 W. Służy do zasilania pasków LED takich jak LEDS P, LEDS B.

stabilizacja napięcia 12V DC
maksymalna dopuszczalna temperatura obudowy wynosząca 65°C
wbudowane zabezpieczenie przeciwzwarciowe
wbudowane układy redukcji zakłóceń radioelektrycznych i poprawy współczynnika mocy
Materiał: stop aluminium

Kanlux TRETO is an electronic constant-voltage power supply unit with power of 30 W. It is used for powering LED belts such as LEDS P, LEDS B.

Voltage stabilization 12V DC
Maximum permissible housing temperature 65°C
Built-in circuit and overload protection
Built-in radio interference reduction and power factor correction systems
Material: aluminum alloy

Kanlux DimGO to ściemniacz przystosowany do źródeł światła LED. Dzięki zastosowaniu go uzyskujemy możliwość sterowania strumieniem świetlnym źródeł światła LED. Warunkiem zastosowania Kanlux DimGO jest zasilanie przystosowane do regulacji metodą „trailing/leading edge”.

Materiał: tworzywo sztuczne

Kanlux DimGO is a dimmer adapted to LED light sources. It gives you the possibility of controlling the luminous flux of LED light sources. The prerequisite for using the DimGO Kanlux is a power supply adapted to the “trailing/leading edge” adjustment method.

Materiał: plastic



BL-3-4x14H-EVG

model BL-3-4x14H-EVG służy do stabilizacji prądu świetlówek T5, pozostałe modele służą do stabilizacji prądu świetlówek T8

Materiał: stal

BL-3-4x14H-EVG is used for T5 fluorescent lamps current stabilisation, other models are used for T8 fluorescent lamps current stabilisation

Material: steel



BL-3-4x14H-EVG



BL-118H-EVG



BL-136H-EVG



BL-3-4x14H-EVG	08240	5905339082404	3.4 x 14
BL-118H-EVG	70480	5905339704801	1 x 18
BL-136H-EVG	70481	5905339704818	1 x 36
BL-158H-EVG	70482	5905339704825	1 x 58
BL-218H-EVG	70483	5905339704832	2 x 18
BL-236H-EVG	70484	5905339704849	2 x 36
BL-258H-EVG	70485	5905339704856	2 x 58
BL-418H-EVG	70486	5905339704863	4 x 18

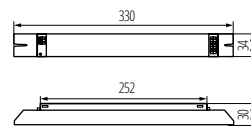

BL-3-4x14H-EVG; BL-418H-EVG

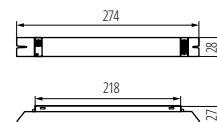

BL-118H-EVG; BL-136H-EVG; BL-218H-EVG

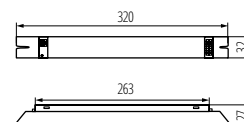

BL-158H-EVG; BL-236H-EVG; BL-258H-EVG



Kanlux

BS

ZAPŁONNIKI BS ► BS IGNITERS



BS-1 4-22W



BS-1 4-22W	07180	5905339071804	4-22
BS-2 4-65W	07181	5905339071811	4-65

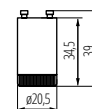

BS



Kanlux

WIR ZL

WENTYLATOR KANAŁOWY ► DUCTED FAN



WIR ZL100



WIR ZL100



WIR ZL120

Przepustnice samoczynne z serii Kanlux WIR ZL dostępne są w dwóch rozmiarach 100 oraz 120mm. Wykonane z tworzywa sztucznego, w kolorze białym.

Automatic dampers from Kanlux WIR ZL series are available in two sizes: 100 and 120mm. They are made of plastic, in white colour.



WIR ZL100	70961	8594056490349	biały white
WIR ZL120	70962	8594056490356	biały white

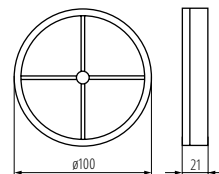

WIR ZL100

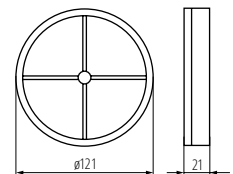

WIR ZL120

TWISTER

WENTYLATOR KANAŁOWY ► DUCTED FAN



TWISTER AOL100B



TWISTER AOL100B



TWISTER AOL100T



TWISTER AOL120B



Seria wentylatorów Kanlux TWISTER AOL dostępna jest w dwóch rozmiarach średnicy 100 i 120 mm. Wykonane są z tworzywa sztucznego, w kolorze białym. Ich moc to odpowiednio 19 i 20 W. Ilość obrotów z każdego rozmiaru wynosi 2550/min.

Kanlux TWISTER AOL series of fans is available in two sizes with diameter of 100 and 120 mm. They are made of plastic, in white colour. Their power is 19 and 20 W respectively. The number of rotations from each size comes to 2550/min.

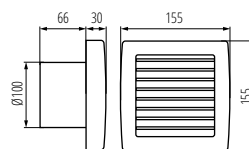

TWISTER AOL100B

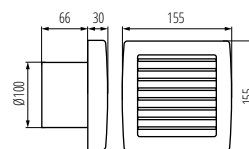

TWISTER AOL100T

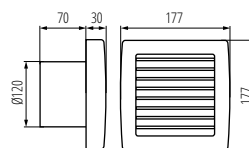

TWISTER AOL120B

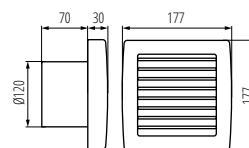

TWISTER AOL120T



TWISTER AOL100B	70926	8594056490172	19	42	100	
TWISTER AOL100T	70953	8594056490202	19	42	100	tak yes
TWISTER AOL120B	70956	8594056490226	20	42	150	
TWISTER AOL120T	70960	8594056490257	20	42	150	tak yes

[V] 220-240 AC	[Hz] 50/60	IP X4				 2550 [rpm]	 1 [mm]	CE	EAC
--------------------------	----------------------	-----------------	--	--	--	----------------	------------	-----------	------------

Kanlux CYKLON

WENTYLATOR KANAŁOWY ► DUCTED FAN



CYKLON EOL100



CYKLON EOL100



CYKLON EOL100B



CYKLON EOL120

Seria wentylatorów Kanlux CYKLON EOL dostępna jest w trzech rozmiarach średnicy 100, 120 oraz 150mm. Wykonane są z tworzywa sztucznego, w kolorze białym. Ich moc to odpowiednio 19, 20 oraz 22W. Ilość obrotów z każdego rozmiaru wynosi 2550/min.

ilość obrotów wynosząca 2550/min

Kanlux CYKLON EOL series of fans is available in three sizes with diameter of 100, 120 and 150mm. They are made of plastic, in white colour. Their power is 19, 20 and 22W respectively. The number of rotations from each size comes to 2550/min.

Rotation speed: 2550/min

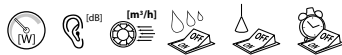

CYKLON EOL100	70910	8594056490011	19	38	100	tak yes	
CYKLON EOL100B	70911	8594056490028	19	38	100		
CYKLON EOL120	70915	8594056490066	20	38	150	tak yes	
CYKLON EOL120B	70916	8594056490073	20	38	150		
CYKLON EOL150	70920	8594056490110	22	38	200	tak yes	
CYKLON EOL150B	70921	8594056490127	22	38	200		
CYKLON EOL100HT	70936	8594056490035	19	38	100	tak yes	tak yes
CYKLON EOL100P	70937	85940564900370	19	38	100	tak yes	
CYKLON EOL100T	70938	8594056490059	19	38	100		tak yes
CYKLON EOL120HT	70941	8594056490080	20	38	150	tak yes	tak yes
CYKLON EOL120P	70942	85940564900387	20	38	150	tak yes	
CYKLON EOL120T	70943	8594056490103	20	38	150		tak yes
CYKLON EOL150P	70947	85940564900394	22	38	200	tak yes	tak yes
CYKLON EOL150T	70948	8594056490158	22	38	200		tak yes

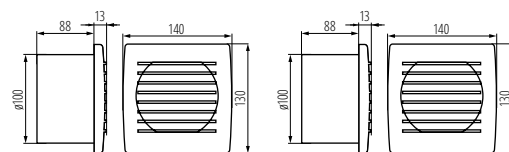

CYKLON EOL100

CYKLON EOL100B

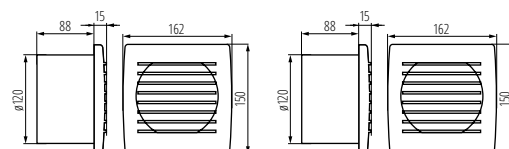

CYKLON EOL120

CYKLON EOL120B



Kanlux LUNGA

PRZEDŁUŻACZ LUNGA ► LUNGA EXTENSION CORD



LUNGA 3 3G1.0X1.4M



LUNGA 3 3G1.0X1.4M

LUNGA 4 3G1.0X1.4M

LUNGA 5 3G1.0X1.4M

Kanlux LUNGA to białe, wielogniazdowe przedłużacze domowe z uziemieniem. Dostępna szeroka gama produktów z ilością od 3 do 6 gniazd. W zależności od potrzeb proponujemy wersję z przełącznikiem lub bez.

Materiał: tworzywo sztuczne

Kanlux LUNGA are white, multi-socket home extension cords with earthing. A wide range of products available with 3-6 sockets. Depending on needs, we propose a version with a switch or without a switch.

Materiał: plastic



LUNGA 3 3G1,0X1,4M	25950	5905339259509	1,4	2500	10
LUNGA 4 3G1,0X1,4M	25951	5905339259516	1,4	2500	10
LUNGA 5 3G1,0X1,4M	25952	5905339259523	1,4	2500	10
LUNGA 6 3G1,0X1,4M	25953	5905339259530	1,4	2500	10
LUNGA 3 3G1,0X3M	26500	5905339265005	3	2500	10
LUNGA 3 3G1,0X5M	26501	5905339265012	5	2500	10
LUNGA 4 3G1,0X3M	26502	5905339265029	3	2500	10
LUNGA 4 3G1,0X5M	26503	5905339265036	5	2500	10
LUNGA 5 3G1,0X3M	26504	5905339265043	3	2500	10
LUNGA 5 3G1,0X5M	26505	5905339265050	5	2500	10
LUNGA 6 3G1,0X3M	26506	5905339265067	3	2500	10
LUNGA 6 3G1,0X5M	26507	5905339265074	5	2500	10

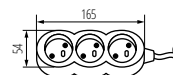

LUNGA 3 3G1.0X1.4M

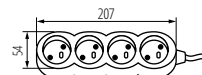

LUNGA 4 3G1.0X1.4M

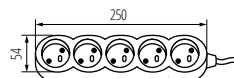

LUNGA 5 3G1.0X1.4M

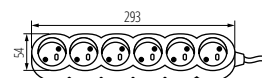

LUNGA 6 3G1.0X1.4M

[V] 250 AC	[Hz] 50/60		 2500	IP 20	In[A] 10		CE	EAC
----------------------	----------------------	--	----------	-----------------	--------------------	--	-----------	------------

Kanlux

LUNGA S

PRZEDŁUŻACZ LUNGA ► LUNGA EXTENSION CORD



LUNGA S3 3G1.0X1.4M



LUNGA S3 3G1.0X1.4M



LUNGA S4 3G1.0X1.4M



LUNGA S5 3G1.0X1.4M

Kanlux LUNGA S to białe, wielogniazdowe przedłużacze domowe z uziemieniem. Dostępna szeroka gama produktów z ilością od 3 do 6 gniazd. W zależności od potrzeb proponujemy wersję z przełącznikiem lub bez.

Materiał: tworzywo sztuczne

Kanlux LUNGA S are white, multi-socket home extension cords with earthing. A wide range of products available with 3-6 sockets. Depending on needs, we propose a version with a switch or without a switch.

Materiał: plastic



LUNGA S3 3G1,0X1,4M	25954	5905339259547	1,4	2500	10	
LUNGA S4 3G1,0X1,4M	25955	5905339259554	1,4	2500	10	
LUNGA S5 3G1,0X1,4M	25956	5905339259561	1,4	2500	10	
LUNGA S6 3G1,0X1,4M	25957	5905339259578	1,4	2500	10	
LUNGA S3 3G1,0X3M	26508	5905339265081	3	2500	10	
LUNGA S3 3G1,0X5M	26509	5905339265098	5	2500	10	
LUNGA S4 3G1,0X3M	26510	5905339265104	3	2500	10	
LUNGA S4 3G1,0X5M	26511	5905339265111	5	2500	10	
LUNGA S5 3G1,0X3M	26512	5905339265128	3	2500	10	
LUNGA S5 3G1,0X5M	26513	5905339265135	5	2500	10	
LUNGA S6 3G1,0X3M	26514	5905339265142	3	2500	10	
LUNGA S6 3G1,0X5M	26515	5905339265159	5	2500	10	

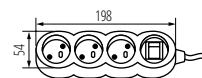

LUNGA S3 3G1.0X1.4M

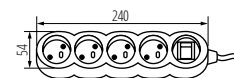

LUNGA S4 3G1.0X1.4M

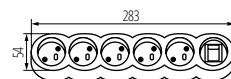

LUNGA S5 3G1.0X1.4M

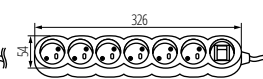

LUNGA S6 3G1.0X1.4M



NOKA W

PRZEDŁUŻACZ NOKA O ► NOKA O EXTENSION CORD



NOKA W 10A 3G1.0X2M



NOKA W 10A 3G1.0X2M

NOKA W 10A 3G1.0X3M

NOKA W 10A 3G1.0X5M

Kanlux NOKA to kompletna oferta przedłużaczy elektrycznych do zastosowań w domu lub w ogrodzie. Do wyboru mamy dwie wersje różniące się kolorem i przeznaczeniem – białe o długość od 2m do 10m (z uziemieniem) oraz pomarańczowe (kosiarkowe) bez uziemienia o długościach 10m, 15m, 20m, 30m i 40m.

Kanlux NOKA is a complete offer of electric extension cords for use at home or in a garden. You can choose two versions different in terms of colour and intended use – white with length from 2m to 10m (with earthing) and orange (mower-type) without earthing with lengths of 10m, 15m, 20m, 30m and 40m.



NOKA W 10A 3G1.0X2M	26200	5905339262004	2	2500	10
NOKA W 10A 3G1.0X3M	26201	5905339262011	3	2500	10
NOKA W 10A 3G1.0X5M	26202	5905339262028	5	2500	10
NOKA W 10A 3G1.0X7M	26203	5905339262035	7	2500	10
NOKA W 10A 3G1.0X10M	26204	5905339262042	10	2500	10

[V] 250 AC	[Hz] 50/60			IP 20		CE	ERC
----------------------	----------------------	--	--	-----------------	--	-----------	------------

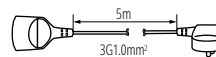

NOKA W 10A 3G1.0X2M

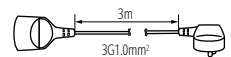

NOKA W 10A 3G1.0X3M

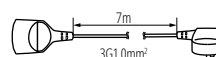

NOKA W 10A 3G1.0X7M

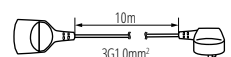

NOKA W 10A 3G1.0X10M

Kanlux

NOKA O

PRZEDŁUŻACZ NOKA O ► NOKA O EXTENSION CORD



NOKA O 16A 3G1.5X15M



NOKA O 16A 3G1.5X15M



NOKA O 16A 3G1.5X20M



NOKA O 16A 3G1.5X25M

Kanlux NOKA to kompletna oferta przedłużaczy elektrycznych do zastosowań w domu lub w ogrodzie. Do wyboru mamy dwie wersje różniące się kolorem i przeznaczeniem – białe o długości od 2m do 10m (z uziemieniem) oraz pomarańczowe (kosiarkowe) bez uziemienia o długościach 10m, 15m, 20m, 30m i 40m.

Kanlux NOKA is a complete offer of electric extension cords for use at home or in a garden. You can choose two versions different in terms of colour and intended use – white with length from 2m to 10m (with earthing) and orange (with earthing) and orange (mower-type) without earthing with lengths of 10m, 15m, 20m, 30m and 40m.

			[m]	[W]	In(A)	
NOKA O 16A 3G1.5X15M	26205	5905339262059	15	3600	16	⏏
NOKA O 16A 3G1.5X20M	26206	5905339262066	20	3600	16	
NOKA O 16A 3G1.5X25M	26207	5905339262073	25	3600	16	
NOKA O 16A 3G1.5X30M	26208	5905339262080	30	3600	16	
NOKA O 16A 3G1.5X40M	26209	5905339262097	40	3600	16	
NOKA O 10A 2G1.0X10M	26210	5905339262103	10	2500	10	□
NOKA O 10A 2G1.0X15M	26211	5905339262110	15	2500	10	
NOKA O 10A 2G1.0X40M	26214	5905339262141	40	2500	10	

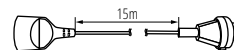

NOKA O 16A 3G1.5X15M

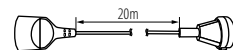

NOKA O 16A 3G1.5X20M

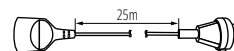

NOKA O 16A 3G1.5X25M

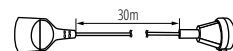

NOKA O 16A 3G1.5X30M

[V] 250 AC
[Hz] 50/60
IP 20
⏏
CE
ERC

Kanlux MANGO

PRZEDŁUŻACZ MANGO ► MANGO EXTENSION CORD



MANGO KF-FBG-20A 25M



MANGO KF-FBG-20A 25M



MANGO KF-FBG-23A 40M



MANGO KF-FBG-23A 50M



Kanlux MANGO to seria przedłużaczy bębnowych z uziemieniem. Dostępne długości to od 25 do 50 metrów.

wyposażone w wyłącznik przeciążeniowy przedłużacze ze stykiem ochronnym, przeznaczone do urządzeń klasy I

wyposażone w przesłony torów prądowych

Kanlux MANGO is a series of drum extension cords with earthing. Available lengths are from 25 to 50 metres.

Equipped with an overload switch

Extension cords with protective contact, for Class I devices

Equipped with current track shutters

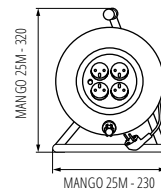

MANGO KF-FBG-20A 25M

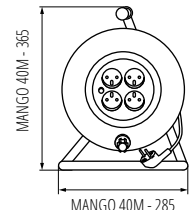

MANGO KF-FBG-23A 40M

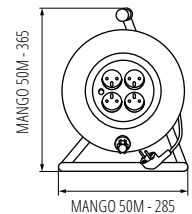

MANGO KF-FBG-23A 50M

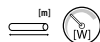

MANGO KF-FBG-20A 25M	04395	5905339043955	25	3200
MANGO KF-FBG-23A 40M	04396	5905339043962	40	3200
MANGO KF-FBG-23A 50M	04397	5905339043979	50	3200

[V] 230 AC	[Hz] 50/60			IP 20		EAC
----------------------	----------------------	--	--	-----------------	--	------------

Kanlux DIVISO

ROZGAŁĘŻNIKI, GNIAZDA, WTYCZKI ► SPLITTERS, SOCKETS, PLUGS



DIVISO W3



DIVISO W3 | **26091** | 5905339260918 | biały | white

[V] 250 AC	[Hz] 50/60	[W] 1875			In[A] 3 x 2,5	IP 20	CE
----------------------	----------------------	--------------------	--	--	-------------------------	-----------------	-----------

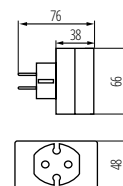

DIVISO W3

Kanlux DIVISO to rodzina kompaktowych rozdzielaczy na wtyczki płaskie. Dostępne są trzech rodzajach, a wykonane z tworzywa sztucznego w kolorze białym.

Materiał: tworzywo sztuczne

Kanlux DIVISO is a family of compact separators for flat plugs. They are made of plastic in white colour and available in three types.

Material: plastic

Kanlux GP-2

ROZGAŁĘŻNIKI, GNIAZDA, WTYCZKI ► SPLITTERS, SOCKETS, PLUGS



GP-2



GP-2 | **70513** | 5905339705136 | biały | white

[V] 250 AC	[Hz] 50/60		In[A] 16	IP 20	CE
----------------------	----------------------	--	--------------------	-----------------	-----------

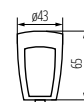

GP-2

gniazdo wtyczkowe do przedłużaczy.

Materiał: tworzywo sztuczne

extension socket for cable cords.

Material: plastic

Kanlux GRIP

ROZGAŁĘŻNIKI, GNIAZDA, WTYCZKI ► SPLITTERS, SOCKETS, PLUGS



GRIP GP/S



GRIP GP/S	04862	5905339048622	czarny black
GRIP W/US	04863	5905339048639	czarny black

[V] 250 AC	[Hz] 50/60		In[A] 16	IP 44	CE
----------------------	----------------------	--	--------------------	-----------------	-----------

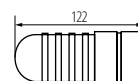

GRIP GP/S

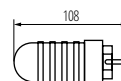

GRIP W/US

gniazdo wtyczkowe do przedłużaczy.
STAN GP posiada I klasę ochronności przed porażeniem elektrycznym
GRIP GP/S wyposażony w uziemienie typu Schuko
Material: tworzywo sztuczne
extension socket for cable cords.
STAN GP has I Class protection against electric shock
GRIP GP/S equipped with Schuko earthing
Material: plastic

Kanlux PIN W/US

ROZGAŁĘŻNIKI, GNIAZDA, WTYCZKI ► SPLITTERS, SOCKETS, PLUGS



PIN W/US



PIN W/US	02186	5905339021861	biały white
----------	--------------	---------------	---------------

[V] 250 AC	[Hz] 50/60			In[A] 16	IP 20	CE
----------------------	----------------------	--	--	--------------------	-----------------	-----------

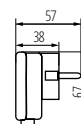

PIN W/US

gniazdo wtyczkowe do przedłużaczy.
wyposażone w styk ochronny
Material: tworzywo sztuczne
extension socket for cable cords.
Equipped with protective contact
Material: plastic

Kanlux STAN GP

ROZGAŁĘŹNIKI, GNIAZDA, WTYCZKI STAN GP ► STAN GP SPLITTERS, SOCKETS, PLUGS



STAN GP



STAN GP | **04864** | 5905339048646 | czarny | black

[V] 250 AC	[Hz] 50/60		In[A] 16	IP 44	CE
---------------	---------------	--	-------------	----------	----

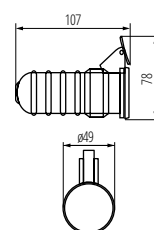

STAN GP

gniazdo wtychkowe do przedłużaczy.
Materiał: tworzywo sztuczne
extension socket for cable cords.
Material: plastic

Kanlux W-1 NANO

ROZGAŁĘŹNIKI, GNIAZDA, WTYCZKI ► SPLITTERS, SOCKETS, PLUGS



NANO W-1



NANO W-1 | **70514** | 5905339705143 | biały | white

[V] 250 AC	[Hz] 50/60		In[A] 16	IP 20	CE
---------------	---------------	--	-------------	----------	----

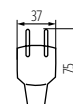

NANO W-1

gniazdo wtychkowe do przedłużaczy.
Materiał: tworzywo sztuczne
extension socket for cable cords.
Material: plastic

Kanlux ZARK

ROZGAŁĘŻNIKI, GNIAZDA, WTYCZKI ► SPLITTERS, SOCKETS, PLUGS



ZARK KRT/2-1



ZARK KRT/2-1	02180	5905339021809	biały white
ZARK KRW-3	02181	5905339021816	biały white

[V]	[Hz]	[W]	⊕	🏠	In[A]	IP	CE
250 AC	50/60	2300			16	20	

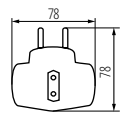

ZARK KRT/2-1

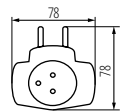

ZARK KRW-3

Kanlux APO

ZEGAR/PROGRAMATOR STERUJĄCY ► CONTROL TIMER / PROGRAMMER



APO TM-3



APO TM-3	07980	5905339079800	1150	1
----------	--------------	---------------	------	---

[V]	[Hz]	In[A]	[W]	IP	🏠	⊕	CE	ERC
220-240 AC	50/60	5	1150	20				

Brakuje Ci miejsca do podłączenia kolejnego urządzenia do kontaktu? Nic, prostszego, rozgałęźniki Kanlux ZARK rozwiążą Twój problem. Zyskasz tym samym trzy nowe wejścia do kontaktu.

wyposażony w styk ochronny

Material: tworzywo sztuczne

Don't you have enough room for connecting another device to the socket? Nothing simpler - Kanlux ZARK distributors will solve your problem. Thereby, you will have three new inputs to the socket.

Equipped with protective contact

Material: plastic

Kanlux APO to komplet 3 adapterów gniazd wtyczkowych z możliwością zdalnego sterowania za pomocą pilota. Każde podłączone urządzenie możemy uruchamiać niezależnie od innych.

w komplecie: 3 gniazda, pilot, bateria

przy obciążeniu impedancyjnym maksymalne obciążenie wynosi 1150W

gniazdka instalować można obok siebie w odległości nie mniejszej niż 0,5m

dioda sygnalizuje pracę gniazdka elektrycznego

zasięg działania pilota wynosi 25m (do 50m w otwartej przestrzeni)

Kanlux APO is a set of 3 adapters of extension sockets with a possibility of remote control by means of a remote control. Each connected device can be activated independently of others.

in the set: 3 sockets, remote control, battery

Maximum load with inductive load 1150W

Sockets can be installed next to one another at a distance of at least 0,5m

LED indicates that the electrical socket is operational

Remote control range 25m (up to 50m in the open space)

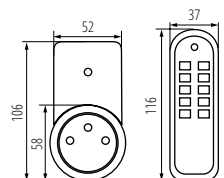

APO TM-3

Kanlux

BR-GZ10

OPRAWA DO ŻARÓWEK BR-GZ10 ► BR-GZ10 LIGHT BULB FITTING



BR-GZ10



BR-GZ10 | 72369 | 5905339723697 | szary | grey

[V] 250 AC	[Hz] 50/60	In[A] 2	GU10	IP 00		CE
----------------------	----------------------	-------------------	-------------	-----------------	--	-----------

maksymalna dopuszczalna temperatura oprawki dla BR-GZ10, HLDR-GZ10, HLDR-R7S wynosząca 250°C, dla pozostałych modeli wynosząca 180°C

maksymalny dopuszczalny prąd dla BR-GZ10, HLDR-GZ10, HLDR-G9 wynoszący 2A, dla HLDR-R7S wynoszący 6A, dla HLDR-GX5.3 wynoszący 5A

BR-GZ10 wyposażona we wspornik

Maximum permissible holder temperature 250°C for BR-GZ10, HLDR-GZ10, HLDR-R7S, for other models – 180°C

Maximum permissible current for BR-GZ10, HLDR-GZ10, HLDR-G9 – 2A, for HLDR-R7S – 6A, for HLDR-GX5.3 – 5A

BR-GZ10 equipped with a support

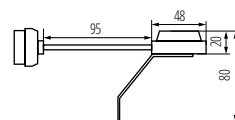

BR-GZ10

maksymalna dopuszczalna temperatura oprawki wynosząca 180°C

Maximum permissible holder temperature 180°C

Kanlux

HLDR-E14

OPRAWKA DO ŹRÓDEŁ ŚWIATŁA ► LIGHT SOURCE FITTING



HLDR-E14



HLDR-E14 | 02170 | 5905339021700 | szary | grey

[V] 250 AC	[Hz] 50/60	In[A] 2	E14	IP 00		CE
----------------------	----------------------	-------------------	------------	-----------------	--	-----------

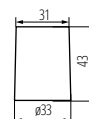

HLDR-E14

Kanlux

HLDR-E14

OPRAWKA DO ŹRÓDEŁ ŚWIATŁA ► LIGHT SOURCE FITTING



HLDR-E14-F



HLDR-E14-F | 02173 | 5905339021731 szary | grey

[V] 250 AC	[Hz] 50/60	In[A] 2	E14	IP 00		CE
----------------------	----------------------	-------------------	------------	-----------------	--	-----------



maksymalna dopuszczalna temperatura oprawki wynosząca 180°C

Maximum permissible holder temperature 180°C

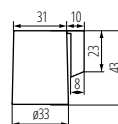

HLDR-E14-F

Kanlux

HLDR-E27

OPRAWKA DO ŹRÓDEŁ ŚWIATŁA ► LIGHT SOURCE FITTING



HLDR-E27



HLDR-E27 | 02160 | 5905339021601 szary | grey

[V] 250 AC	[Hz] 50/60	In[A] 4	E27	IP 00		CE
----------------------	----------------------	-------------------	------------	-----------------	---	-----------



maksymalna dopuszczalna temperatura oprawki wynosząca 180°C

Maximum permissible holder temperature 180°C

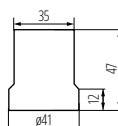

HLDR-E27

Kanlux

HLDR-E27

OPRAWKA DO ŹRÓDEŁ ŚWIATŁA ► LIGHT SOURCE FITTING



HLDR-E27-D



HLDR-E27-D | **02162** | 5905339021625 szary | grey

[V] 250 AC	[Hz] 50/60	In[A] 4		IP 00	IP 00		
----------------------	----------------------	-------------------	--	-----------------	-----------------	--	--



| maksymalna dopuszczalna temperatura oprawki wynosząca 180°C

| Maximum permissible holder temperature 180°C

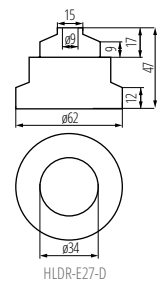

Kanlux

HLDR-E27

OPRAWKA DO ŹRÓDEŁ ŚWIATŁA ► LIGHT SOURCE FITTING



HLDR-E27-F



HLDR-E27-F | **02161** | 5905339021618 szary | grey

[V] 250 AC	[Hz] 50/60	In[A] 4		IP 00	IP 00		
----------------------	----------------------	-------------------	--	-----------------	-----------------	--	--



| maksymalna dopuszczalna temperatura oprawki wynosząca 180°C

| Maximum permissible holder temperature 180°C

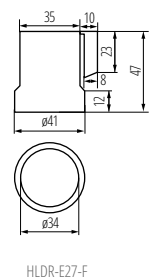

Kanlux

HLDR-G9

OPRAWKA DO ŹRÓDEŁ ŚWIATŁA ► LIGHT SOURCE FITTING



HLDR-G9



HLDR-G9 | **08220** | 5905339082206 | szary | grey

[V] 250 AC	In[A] 2	G9	IP 00	CE
----------------------	-------------------	-----------	-----------------	-----------



HLDR-G9

Kanlux

HLDR-GX5.3

OPRAWKA DO ŹRÓDEŁ ŚWIATŁA ► LIGHT SOURCE FITTING



HLDR-G9



HLDR-GX5,3 | **72109** | 5905339721099 | szary | grey

[V] 24 AC; 24 DC	In[A] 5	Gx5,3	IP 00		CE
----------------------------	-------------------	--------------	-----------------	--	-----------

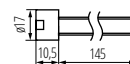

HLDR-G9

maksymalna dopuszczalna temperatura oprawki dla BR-GZ10, HLDR-GZ10, HLDR-R7S wynosząca 250°C, dla pozostałych modeli wynosząca 180°C

maksymalny dopuszczalny prąd dla BR-GZ10, HLDR-GZ10, HLDR-G9 wynoszący 2A, dla HLDR-R7S wynoszący 6A, dla HLDR-GX5.3 wynoszący 5A

BR-GZ10 wyposażona we wspornik

Maximum permissible holder temperature 250°C for BR-GZ10, HLDR-GZ10, HLDR-R7S, for other models – 180°C

Maximum permissible current for BR-GZ10, HLDR-GZ10, HLDR-G9 – 2A, for HLDR-R7S – 6A, for HLDR-GX5.3 – 5A

BR-GZ10 equipped with a support

maksymalna dopuszczalna temperatura oprawki dla BR-GZ10, HLDR-GZ10, HLDR-R7S wynosząca 250°C, dla pozostałych modeli wynosząca 180°C

maksymalny dopuszczalny prąd dla BR-GZ10, HLDR-GZ10, HLDR-G9 wynoszący 2A, dla HLDR-R7S wynoszący 6A, dla HLDR-GX5.3 wynoszący 5A

BR-GZ10 wyposażona we wspornik

Maximum permissible holder temperature 250°C for BR-GZ10, HLDR-GZ10, HLDR-R7S, for other models – 180°C

Maximum permissible current for BR-GZ10, HLDR-GZ10, HLDR-G9 – 2A, for HLDR-R7S – 6A, for HLDR-GX5.3 – 5A

BR-GZ10 equipped with a support

Kanlux

HLDR-GZ10

OPRAWKA DO ŹRÓDEŁ ŚWIATŁA ► LIGHT SOURCE FITTING



HLDR-GZ10



HLDR-GZ10 | **00402** | 5905339004024 | szary | grey

[V] 250 AC	In[A] 2	 GU10	IP 00	CE
----------------------	-------------------	----------	-----------------	-----------

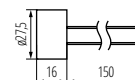

HLDR-GZ10

Kanlux

HLDR-G7S

OPRAWKA DO ŹRÓDEŁ ŚWIATŁA ► LIGHT SOURCE FITTING



HLDR-R7S



HLDR-R7S | **00405** | 5905339004055 | szary | grey

[V] 250 AC	In[A] 6	 R7s	IP 00	CE
----------------------	-------------------	---------	-----------------	-----------

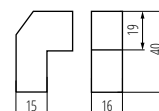

HLDR-R7S

maksymalna dopuszczalna temperatura oprawki dla BR-GZ10, HLDR-GZ10, HLDR-R7S wynosząca 250°C, dla pozostałych modeli wynosząca 180°C

maksymalny dopuszczalny prąd dla BR-GZ10, HLDR-GZ10, HLDR-G9 wynoszący 2A, dla HLDR-R7S wynoszący 6A, dla HLDR-GX5.3 wynoszący 5A

BR-GZ10 wyposażona we wspornik

Maximum permissible holder temperature 250°C for BR-GZ10, HLDR-GZ10, HLDR-R7S, for other models – 180°C

Maximum permissible current for BR-GZ10, HLDR-GZ10, HLDR-G9 – 2A, for HLDR-R7S – 6A, for HLDR-GX5.3 – 5A

BR-GZ10 equipped with a support

maksymalna dopuszczalna temperatura oprawki dla BR-GZ10, HLDR-GZ10, HLDR-R7S wynosząca 250°C, dla pozostałych modeli wynosząca 180°C

maksymalny dopuszczalny prąd dla BR-GZ10, HLDR-GZ10, HLDR-G9 wynoszący 2A, dla HLDR-R7S wynoszący 6A, dla HLDR-GX5.3 wynoszący 5A

BR-GZ10 wyposażona we wspornik

Maximum permissible holder temperature 250°C for BR-GZ10, HLDR-GZ10, HLDR-R7S, for other models – 180°C

Maximum permissible current for BR-GZ10, HLDR-GZ10, HLDR-G9 – 2A, for HLDR-R7S – 6A, for HLDR-GX5.3 – 5A

BR-GZ10 equipped with a support

Kanlux

HLDR-E14/GU10

PRZEJŚCIÓWKA DO ŹRÓDEŁ ŚWIATŁA ► ADAPTOR FOR LIGHT SOURCES



HLDR-G9



HLDR-E14/GU10 | 08851 | 5905339088512 | biały | white

[V]	[Hz]	In[A]	IP		CE
250 AC	50/60	2	00	35	



- maksymalna dopuszczalna temperatura oprawki wynosząca 180°C
- maksymalna dopuszczalna moc źródła światła 35W
- Materiał: stop metali niekorodujących
- Maximum permissible holder temperature 180°C
- Maximum permissible light source power 35W
- Material: non-corrosive metals alloy

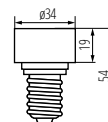

HLDR-G9

Kanlux

HLDR-E27/GU10

PRZEJŚCIÓWKA DO ŹRÓDEŁ ŚWIATŁA ► ADAPTOR FOR LIGHT SOURCES



HLDR-E27/GU10



HLDR-E27/GU10 | 08850 | 5905339088505 | biały | white

[V]	[Hz]	In[A]	IP		CE
250 AC	50/60	2	00	35	



- maksymalna dopuszczalna temperatura oprawki wynosząca 180°C
- maksymalna dopuszczalna moc źródła światła 35W
- Materiał: stop metali niekorodujących
- Maximum permissible holder temperature 180°C
- Maximum permissible light source power 35W
- Material: non-corrosive metals alloy

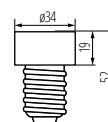

HLDR-E27/GU10

Kanlux STRAP

OPASKA ZACISKOWA STRAP ► STRAP CABLE TIE



STRAP 2,5/100MM



STRAP 2,5/100MM



STRAP 2,5/120MM



STRAP 2,5/150MM

odporność na promieniowanie UV,
mikroorganizmy, bakterie i pleśń
opakowanie jednostkowe zawierające 100 szt.
Materiał: poliamid
Resistant to UV, micro-organisms, bacteria
and mould
unit package containing 100 pcs.
Material: poliamid



STRAP 2,5/100MM	07962	5905339079626	biały white
STRAP 2,5/120MM	07963	5905339079633	biały white
STRAP 2,5/150MM	07965	5905339079657	biały white
STRAP 3,6/150MM	07966	5905339079664	biały white
STRAP 3,6/200MM	07967	5905339079671	biały white
STRAP 3,6/250MM	07968	5905339079688	biały white
STRAP 3,6/300MM	07969	5905339079695	biały white
STRAP 4,6/200MM	07970	5905339079701	biały white
STRAP 4,6/250MM	07971	5905339079718	biały white
STRAP 4,6/300MM	07972	5905339079725	biały white

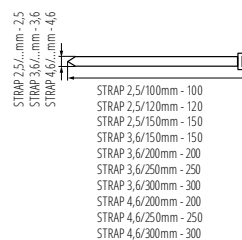



iTECH M2



ZESTAW MONT. P/T iTECH

Oświetlenie awaryjne lub antypaniczne stosuje się w pomieszczeniach typu Open Space, aby przeciwdziałać panice. Pozwala na dotarcie do miejsca, w którym widać oznaczoną drogę ewakuacji jak i oznaczenie samej drogi ewakuacyjnej zależnie od przyzmy zastosowanej w oprawie.
25438 - Zestaw montażowy podtynkowy P/T iTECH.

Materiał obudowy: tworzywo sztuczne

Emergency or anti-panic lighting is used in open space rooms to prevent panic. It allows you to reach a place where you can see the marked escape route as well as for the illumination of the escape route itself, depending on the prism used in the fixture.
25438 - Flush mounting installation set for P/T iTECH.

Enclosure material: plastic

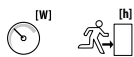

	[W]	[h]						
iTECH C1 302 MAT	27050	5902052505586	2	3	+	ZESTAW MON. P/T iTECH	25438	✓
iTECH C1 302 MAT	27053	5902052505586	2	3	+	ZESTAW MON. P/T iTECH	25438	✓
iTECH C1 302 M ST	27382	5902052505463	2	3	+	ZESTAW MON. P/T iTECH	25438	✓
iTECH F1 302M AT	27635	5902052505821	2	3	+	ZESTAW MON. P/T iTECH	25438	✓
iTECH F1 302M ST	27869	5902052505708	2	3	+	ZESTAW MON. P/T iTECH	25438	✓
iTECH F2 105 M ST	27383	5902052505760	5	1	+	ZESTAW MON. P/T iTECH	25438	✓
iTECH F2 105M AT	27638	5902052505883	5	1	+	ZESTAW MON. P/T iTECH	25438	✓
iTECH M2 102 M COLD AT	27620	5902052504763	2	1	+	ZESTAW MON. P/T iTECH	25438	✓
iTECH M2 102M COLD ST	27823	5902052504640	2	1	+	ZESTAW MON. P/T iTECH	25438	✓
iTECH M2 302 M ST	27380	5902052504626	2	3	+	ZESTAW MON. P/T iTECH	25438	✓
iTECH M5 105 M COLD AT	27623	5902052504848	5	1	+	ZESTAW MON. P/T iTECH	25438	✓
iTECH M5 105 M ST	27381	5902052504688	5	1	+	ZESTAW MON. P/T iTECH	25438	✓
iTECH M5 105M AT	27622	5902052504800	5	1	+	ZESTAW MON. P/T iTECH	25438	✓
iTECH M5 105M COLD ST	27826	5902052504725	5	1	+	ZESTAW MON. P/T iTECH	25438	✓
iTECH M5 305 AT	27052	5902052504824	5	3	+	ZESTAW MON. P/T iTECH	25438	✓
iTECH M5 305M ST	27825	5902052504701	5	3	+	ZESTAW MON. P/T iTECH	25438	✓



AT

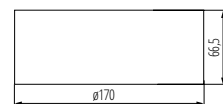

iTECH



Kanlux BOA

OPRAWA AWARYJNA LED ► EMERGENCY LIGHTING LED



BOA IN

Oświetlenie awaryjne lub antypaniczne stosuje się w pomieszczeniach typu Open Space, aby przeciwdziałać panice. Pozwala na dotarcie do miejsca, w którym widać oznaczoną drogę ewakuacji jak i samej ewakuacyjnej zależnie od pryzmy zastosowanej w oprawie. AT - Autotest. ST - test ręczny lub za pomocą zdalnego urządzenia testującego.

Materiał obudowy: tworzywo sztuczne

Emergency or anti-panic lighting is used in open space rooms to prevent panic. It allows you to reach a place where you can see the marked escape route as well as for the illumination of the escape route itself, depending on the prism used in the fixture. AT - Autotest. ST - manual test or with the use of a remote-controlled testing device.

Enclosure material: plastic

			[W]	[h]	AT
BOA IN C1 302M AT	27862	5902052505166	2	3	✓
BOA IN RC1 302M ST	27860	5902052505104	2	3	
BOA IN RM1 301M AT	27822	5902052504428	1	3	✓
BOA IN RM1 301M ST	27820	5902052504329	1	3	
BOA IN RM2 302M AT	27403	5902052504480	2	3	✓
BOA IN RM2 302M ST	27821	5902052504381	2	3	

[V] 220-240 AC	[Hz] 50/60	IP 65	5000					10+40			CE	EMC
-------------------	---------------	----------	------	--	--	--	--	-------	--	--	----	-----

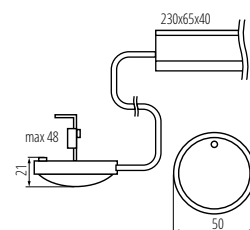

BOA IN

ONTEC S

OPRAWA AWARYJNA LED ► EMERGENCY LIGHTING LED



ONTEC S M1 301M



Oświetlenie awaryjne lub antypaniczne stosuje się w pomieszczeniach typu Open Space, aby przeciwdziałać panice. Pozwala na dotarcie do miejsca, w którym widać oznaczoną drogę ewakuacji jak i oznaczenie samej drogi ewakuacyjnej zależnie od przyzmy zastosowanej w oprawie.

Materiał obudowy: tworzywo sztuczne

Materiał klosza: tworzywo sztuczne



Emergency or anti-panic lighting is used in open space rooms to prevent panic. It allows you to reach a place where you can see the marked escape route as well as for the illumination of the escape route itself, depending on the prism used in the fixture.

Enclosure material: plastic

Lampshade material: plastic



AT

			(W)	(h)	
ONTEC S C1 302M AT	27652	5902052502523	2	3	✓
ONTEC S C1 302M ST	27880	5902052502400	2	3	
ONTEC S M1 301 M AT	27054	5902052500963	1	3	✓
ONTEC S M1 301 M ST	27396	5902052500826	1	3	
ONTEC S M1 301M ST IP44	27920	5902052570294	1	3	
ONTEC S M1U 301NM ST IP44	27944	5902052587223	1	3	
ONTEC S M2 102 M AT	27057	5902052501021	2	1	✓
ONTEC S M2 102M AT	27646	5902052500970	2	1	✓
ONTEC S M2 102M ST	27827	5902052500833	2	1	
ONTEC S M2 302 M COLD AT	27056	5902052501045	2	3	✓
ONTEC S M2 302M AT	27647	5902052500987	2	3	✓
ONTEC S M2 302M COLD ST	27831	5902052500901	2	3	
ONTEC S M2 302M ST	27828	5902052500840	2	3	
ONTEC S M5 105M AT	27648	5902052500994	5	1	✓
ONTEC S M5 105M ST	27829	5902052500857	5	1	
ONTEC S M5 305M AT	27649	5902052501007	5	3	✓
ONTEC S M5 305M ST	27830	5902052500864	5	3	
ONTEC S W1 302 M COLD AT	25436	5902052503063	2	3	✓
ONTEC S W1 302 M COLD ST	27895	5902052502943	2	3	
ONTEC S W1 302M AT	27664	5902052503001	2	3	✓
ONTEC S W1 302M ST	27892	5902052502882	2	3	

[V]	[Hz]	IP	TC [K]												
220-240 AC	50/60	65	5000												

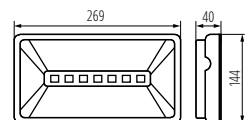

ONTEC S M1 301M

Kanlux

ONTEC S

ZESTAW MONTAŻOWY PODTYNKOWY ONTEC S ► FLUSH MOUNTING INSTALLATION SET FOR ONTEC S



ZEST. MONT. P/T ONTEC S

ZEST.MONT.P/T ONTEC S | **27398** | 5902052506422

Kanlux

ONTEC S

ZESTAW MONTAŻOWY FLAGI ONTEC S ► FLAG MOUNTING INSTALLATION SET FOR ONTEC S



ZEST. MONT. FLAGI ONTEC S

ZEST. MONT. FLAGI*ONTEC S | **27397** | 5902052506415

ONTEC R

OPRAWA AWARYJNA LED ► EMERGENCY LIGHTING LED



ONTEC R M2 102 M

Oświetlenie awaryjne lub antypaniczne stosuje się w pomieszczeniach typu Open Space, aby przeciwdziałać panice. Pozwala na dotarcie do miejsca, w którym widać oznaczoną drogę ewakuacji jak i samej ewakuacyjnej zależnie od przyśmy zastosowanej w oprawie. 27399 - Zestaw montażowy podtynkowy ONTEC R. AT - Autotest. ST - test ręczny lub za pomocą zdalnego urządzenia testującego.

Materiał obudowy: tworzywo sztuczne

Emergency or anti-panic lighting is used in open space rooms to prevent panic. It allows you to reach a place where you can see the marked escape route as well as for the illumination of the escape route itself, depending on the prism used in the fixture. 27399 - Flush mounting installation set for ONTEC R. AT - Autotest. ST - manual test or with the use of a remote-controlled testing device.

Enclosure material: plastic



ZESTAW MONT. P/T ONTEC R

			[W]	[h]						
ONTEC R C1 102 M ST	27392	5902052558599	2	1	+	ZEST. MONT.P/T ONTEC R	27399	✓		AT
ONTEC R C1 102M AT	27738	5902052558650	2	1	+	ZEST. MONT.P/T ONTEC R	27399	✓	✓	
ONTEC R C1 302 M ST	27393	5902052558605	2	3	+	ZEST. MONT.P/T ONTEC R	27399	✓	✓	
ONTEC R C1 302M AT	27739	5902052558667	2	3	+	ZEST. MONT.P/T ONTEC R	27399	✓	✓	
ONTEC R M2 102 M ST	27390	5902052556755	2	1	+	ZEST. MONT.P/T ONTEC R	27399	✓	✓	
ONTEC R M2 102M AT	27730	5902052556816	2	1	+	ZEST. MONT.P/T ONTEC R	27399	✓	✓	
ONTEC R M2 302 M ST	27391	5902052556762	2	3	+	ZEST. MONT.P/T ONTEC R	27399	✓	✓	
ONTEC R M2 302M AT	27731	5902052556823	2	3	+	ZEST. MONT.P/T ONTEC R	27399	✓	✓	
ONTEC R M5 105M AT	27732	5902052570331	5	1	+	ZEST. MONT.P/T ONTEC R	27399	✓	✓	
ONTEC R M5 105M ST	27850	5902052570355	5	1	+	ZEST. MONT.P/T ONTEC R	27399	✓	✓	

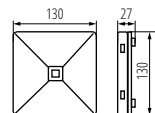

ONTEC R M2 102 M



ONTEC G

OPRAWA AWARYJNA LED ► EMERGENCY LIGHTING LED



ONTEC G E1B



ZEST. MONT. P/T

Oświetlenie awaryjne lub antypaniczne stosuje się w pomieszczeniach typu Open Space, aby przeciwdziałać panice. Pozwala na dotarcie do miejsca, w którym widać oznaczoną drogę ewakuacji jak i samej ewakuacyjnej zależnie od przyzmy zastosowanej w oprawie. 27051 - Zestaw montażowy podtynkowy ONTEC G. AT - Autotest. ST - test ręczny lub za pomocą zdalnego urządzenia testującego.

Materiał obudowy: tworzywo sztuczne

Emergency or anti-panic lighting is used in open space rooms to prevent panic. It allows you to reach a place where you can see the marked escape route as well as for the illumination of the escape route itself, depending on the prism used in the fixture. 27051 - Flush mounting installation set for ONTEC G. AT - Autotest. ST - manual test or with the use of a remote-controlled testing device.

Enclosure material: plastic

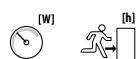

AT

ONTEC G E1B 101 M ST	27394	5902052515868	1	1	+	ZEST.MONT.P/T ONTEC G	27051
ONTEC G E1B 301M AT	25435	5902052515899	1	3	+	ZEST.MONT.P/T ONTEC G	27051
ONTEC G E1B 301M ST	27395	5902052511365	1	3	+	ZEST.MONT.P/T ONTEC G	27051
ONTEC G E1B 101M AT	27750	5902052515905	1	1	+	ZEST.MONT.P/T ONTEC G	27051

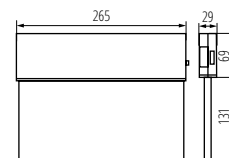

ONTEC G E1B

ONTEC C

OPRAWA AWARYJNA LED ► EMERGENCY LIGHTING LED



ONTEC C 1, M2



AT

ONTEC C C1 102M AT	27684	5902052557554	2	1	✓
ONTEC C C1 102M ST	27902	5902052557493	2	1	✓
ONTEC C M2 102M AT	27672	5902052556090	2	1	✓
ONTEC C M2 102M ST	27838	5902052556038	2	1	✓
ONTEC C M2 302M AT	27673	5902052556106	2	3	✓
ONTEC C M2 302M ST	27839	5902052556045	2	3	✓

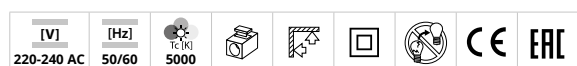

Oświetlenie awaryjne lub antypaniczne stosuje się w pomieszczeniach typu Open Space, aby przeciwdziałać panice. Pozwala na dotarcie do miejsca, w którym widać oznaczoną drogę ewakuacji jak i samej ewakuacyjnej zależnie od przyzmy zastosowanej w oprawie. AT - Autotest. ST - test ręczny lub za pomocą zdalnego urządzenia testującego.

Materiał obudowy: tworzywo sztuczne

Emergency or anti-panic lighting is used in open space rooms to prevent panic. It allows you to reach a place where you can see the marked escape route as well as for the illumination of the escape route itself, depending on the prism used in the fixture. AT - Autotest. ST - manual test or with the use of a remote-controlled testing device.

Enclosure material: plastic

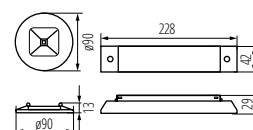

ONTEC C 1, M2

Kanlux VIP ST2

MODUŁ AWARYJNY ► EMERGENCY UNITS

Kanlux VIP to zestaw zasilania awaryjnego do fluorescencyjnych źródeł światła. Przeznaczony jest do montażu w oprawkach oświetleniowych. AT - Autotest. ST - test ręczny lub za pomocą zdalnego urządzenia testującego.

Materiał obudowy: tworzywo sztuczne

Kanlux VIP is an emergency power kit for fluorescent light sources. It is designed for installation in lighting fixtures. AT - Autotest. ST - manual test or with the use of a remote-controlled testing device.

Enclosure material: plastic



VIP 136 ST 2



VIP 158 ST 2



VIP PRO 180i AT

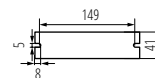
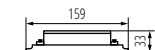

VIP 136 ST 2

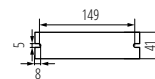
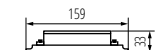

VIP 158 ST 2

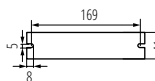
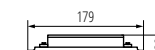

VIP PRO 180i AT



AT

VIP 136 ST 2	27400	5902052504084	4-36	1	
VIP 158 ST 2	27401	5902052504114	3-58	1	
VIP PRO 180i AT	27942	5902052504244	4-80	1	✓

[V]	[Hz]				
220-240 AC	50/60				

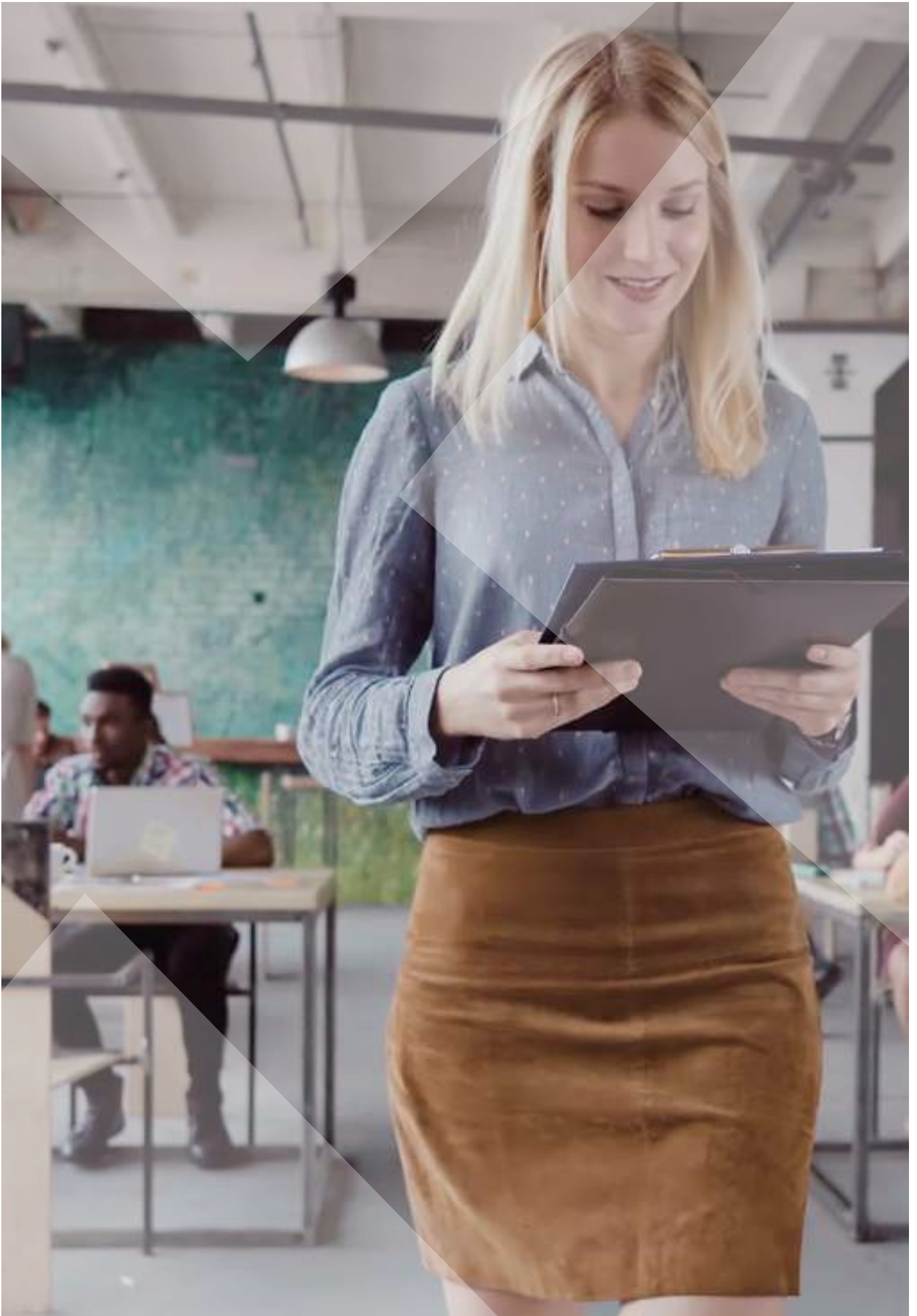

PICTO ONTEC G

ZNAK EWAKUACYJNY ► EMERGENCY EXIT SIGN



PICTO ONTEC G TMP1



PICTO ONTEC G TMP1



PICTO ONTEC G TMP11



PICTO ONTEC G TMP17



PICTO ONTEC G TMP2



PICTO ONTEC G TMP12



PICTO ONTEC G TMP18



PICTO ONTEC G TMP5



PICTO ONTEC G TMP67



PICTO ONTEC G TMP50



PICTO ONTEC G TMP6



PICTO ONTEC G TMP68



PICTO ONTEC G TMP51



PICTO ONTEC G TMP7



PICTO ONTEC G TMP13



PICTO ONTEC G TMP21



PICTO ONTEC G TMP8



PICTO ONTEC G TMP14



PICTO ONTEC G TMP22



PICTO ONTEC G TMP9



PICTO ONTEC G TMP15



PICTO ONTEC G TMP23



PICTO ONTEC G TMP10



PICTO ONTEC G TMP16

PICTO ONTEC G TMP1	27480	5905339274809
PICTO ONTEC G TMP2	27481	5905339274816
PICTO ONTEC G TMP5	27482	5905339274823
PICTO ONTEC G TMP6	27483	5905339274830
PICTO ONTEC G TMP7	27484	5905339274847
PICTO ONTEC G TMP8	27485	5905339274854
PICTO ONTEC G TMP9	27486	5905339274861
PICTO ONTEC G TMP10	27487	5905339274878
PICTO ONTEC G TMP11	27488	5905339274885
PICTO ONTEC G TMP12	27489	5905339274892
PICTO ONTEC G TMP13	27490	5905339274908
PICTO ONTEC G TMP14	27491	5905339274915
PICTO ONTEC G TMP15	27492	5905339274922
PICTO ONTEC G TMP16	27493	5905339274939
PICTO ONTEC G TMP17	27494	5905339274946
PICTO ONTEC G TMP18	27495	5905339274953
PICTO ONTEC G TMP21	27496	5905339274960
PICTO ONTEC G TMP22	27497	5905339274977
PICTO ONTEC G TMP23	27498	5905339274984
PICTO ONTEC G TMP50	27501	5905339275011
PICTO ONTEC G TMP51	27502	5905339275028
PICTO ONTEC G TMP67	27499	5905339274991
PICTO ONTEC G TMP68	27500	5905339275004

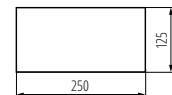

PICTO ONTEC G

PICTO ONTEC S

ZNAK EWAKUACYJNY ► EMERGENCY EXIT SIGN



PICTO ONTEC S TMP1



PICTO ONTEC S TMP1



PICTO ONTEC S TMP11



PICTO ONTEC S TMP17

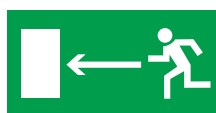

PICTO ONTEC S TMP2



PICTO ONTEC S TMP12



PICTO ONTEC S TMP18



PICTO ONTEC S TMP5



PICTO ONTEC S TMP67



PICTO ONTEC S TMP50



PICTO ONTEC S TMP6



PICTO ONTEC S TMP68



PICTO ONTEC S TMP51



PICTO ONTEC S TMP7



PICTO ONTEC S TMP13



PICTO ONTEC S TMP21



PICTO ONTEC S TMP8



PICTO ONTEC S TMP14



PICTO ONTEC S TMP22



PICTO ONTEC S TMP9



PICTO ONTEC S TMP15



PICTO ONTEC S TMP23



PICTO ONTEC S TMP10



PICTO ONTEC S TMP16

PICTO ONTEC S TMP1	27503	5905339275035
PICTO ONTEC S TMP2	27504	5905339275042
PICTO ONTEC S TMP5	27505	5905339275059
PICTO ONTEC S TMP6	27506	5905339275066
PICTO ONTEC S TMP7	27507	5905339275073
PICTO ONTEC S TMP8	27508	5905339275080
PICTO ONTEC S TMP9	27509	5905339275097
PICTO ONTEC S TMP10	27510	5905339275103
PICTO ONTEC S TMP11	27511	5905339275110
PICTO ONTEC S TMP12	27512	5905339275127
PICTO ONTEC S TMP13	27513	5905339275134
PICTO ONTEC S TMP14	27514	5905339275141
PICTO ONTEC S TMP15	27515	5905339275158
PICTO ONTEC S TMP16	27516	5905339275165
PICTO ONTEC S TMP17	27517	5905339275172
PICTO ONTEC S TMP18	27518	5905339275189
PICTO ONTEC S TMP21	27519	5905339275196
PICTO ONTEC S TMP22	27520	5905339275202
PICTO ONTEC S TMP23	27521	5905339275219
PICTO ONTEC S TMP50	27524	5905339275240
PICTO ONTEC S TMP51	27525	5905339275257
PICTO ONTEC S TMP67	27522	5905339275226
PICTO ONTEC S TMP68	27523	5905339275233

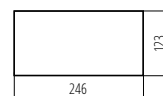

PICTO ONTEC S



IT-1/10-B

IT-1: oferowane wyłącznie w opakowaniach podzbiórczych (10 szt.)
 IT-1/20- MIX: unit package containing 10 pcs.
 IT-1: offered only in sub-packaging (10 pcs.)



IT-1/10-B



IT-1/20-B



IT-1/20-Y



IT-1/10-B	01257	5905339012579	czarny black
IT-1/20-B	01271	5905339012715	czarny black
IT-1/20-Y	01272	5905339012722	żółty yellow
IT-1/20-RE	01273	5905339012739	czerwony red
IT-1/20-GN	01274	5905339012746	zielony green
IT-1/20-BL	01275	5905339012753	niebieski blue
IT-1/20-W	01276	5905339012760	biały white
IT-1/20-Y/GN	01277	5905339012777	żółty / zielony yellow / green
IT-1/20-MIX	01283	5905339012838	wielokolorowy multicoloured

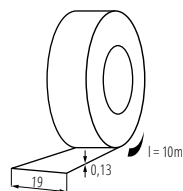

IT-1/10-B

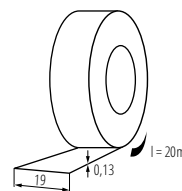

IT-1/20-B

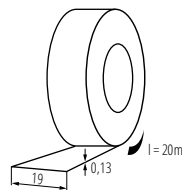

IT-1/20-Y

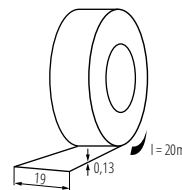

IT-1/20-RE





IP **Objaśnienia stopnia odporności na wnikanie ciał stałych, pyłu i wilgoci**
Explanation of degree of resistance to penetration of foreign solids, dust and humidity

Stopień zabezpieczenia przed nieumyślnym kontaktem z częściami pod napięciem
Degree of protection against inadvertent contact with the live parts

IP	Rysunek / Picture	Opis / Description	Wyjaśnienie / Explanation
0		Brak ochrony No protection	Brak specjalnych środków ochrony No special protection means
1		Ochrona przed ciałami stałymi o wielkości ponad 50mm Protection against solids bigger than 50mm	Duża powierzchnia ciała ludzkiego, równa np. powierzchni dłoni (brak zabezpieczenia przed dotykiem). Ciała stałe o średnicy ponad 50mm Large parts of a human body, equal to e.g. the area of a palm (no protection against touching). Solids with the diameter above 50mm
2		Ochrona przed ciałami stałymi przekraczającymi 12mm Protection against solids bigger than 12mm	Palec lub podobne przedmioty o długości nie przekraczającej 80mm. Ciała stałe o średnicy powyżej 12mm A finger or similar objects not longer than 80mm. Solids with the diameter above 12mm
3		Ochrona przed ciałami stałymi przekraczającymi 2,5mm Protection against solids bigger than 2,5mm	Narzędzia, drut, itp. o średnicy lub grubości przekraczającej 2,5mm. Ciała stałe o średnicy powyżej 2,5mm Tools, a wire etc. with the diameter or the wire gauge exceeding 2,5mm. Solids with the diameter above 2,5mm
4		Ochrona przed ciałami stałymi przekraczającymi 1mm Protection against solids bigger than 1mm	Drut lub taśma o grubości 1mm. Ciała stałe o średnicy przekraczającej 1mm A wire or a strip 1mm thick. Solids with the diameter above 1mm
5		Pyłoodporność Dust resistance	Niewielka ilość pyłu przedostaje się do wnętrza osłony, lecz jest tak mała, że nie wywiera ujemnego wpływu na pracę wyposażenia Small amount of dust penetrates the shield interior but it is so small that it does not exert a negative influence on the equipment operation
6		Pyłoszczelność Dust-proofing	Pył nie przedostaje się do wnętrza osłony Dust does not penetrate the shield interior

Stopień zabezpieczenia przed wilgocią
Degree of protection against moisture

IP	Rysunek / Picture	Opis / Description	Wyjaśnienie / Explanation
0		Brak ochrony No protection	Brak specjalnych środków ochrony No special protection measures
1		Ochrona przed pionowo wpadającymi kroplami wody Protection against vertically falling water drops	Padające pionowo krople wody nie mogą wywołać szkodliwych skutków w urządzeniu Vertically falling water drops cannot cause detrimental effects within the equipment
2		Ochrona przed kroplami wody przy przechyleniu do 15° Protection against water drops at up to 15-degree angle of deflection	Padające pionowo krople wody nie mogą wywołać szkodliwych skutków przy przechyleniu osłony do 15° względem położenia normalnego Vertically falling water drops cannot cause detrimental effects within the equipment when the shield is tilted up to 15 degrees from its normal position
3		Ochrona przed rozpyloną wodą Protection against sprayed water	Rozpylona woda padająca pod kątem 60° od pionu nie powinna wywołać szkodliwych efektów Sprayed water falling at a 60-degree angle of deflection from the vertical should not cause detrimental effects
4		Ochrona przed bryzgami wody Protection against water splashes	Woda rozbrzgiwana na osłonę z dowolnego kierunku nie powinna wywołać szkodliwych skutków Water splashed onto the shield from any direction should not cause detrimental effects
5		Ochrona przed strugami wody Protection against water streams	Woda z dyszy skierowana na obudowę z dowolnego kierunku nie powinna wywołać szkodliwych skutków Water from a nozzle directed onto the casing from any direction should not cause detrimental effects
6		Ochrona przed falami Protection against waves	Woda po zalaniu falą lub od silnej strugi nie może dostać się do wnętrza osłony w takiej ilości, aby wywołać szkodliwe skutki A flooding water wave or a strong stream cannot penetrate the shield in the amount causing detrimental effects
7		Ochrona przed zanurzeniem Protection against immersion	Przy zanurzeniu urządzenia do wody na określony czas i przy określonym ciśnieniu, woda nie może dostać się do wnętrza osłony w takiej ilości, aby wywołać szkodliwe skutki When the equipment is immersed in water for the predetermined time and at the predetermined pressure, water cannot penetrate the shield in the amount causing detrimental effects
8		Ochrona przed głębokim zanurzeniem Protection against deep immersion	Urządzenie dostosowane do długotrwałego zanurzenia w wodzie w warunkach określonych przez wytwórcę The equipment adapted to long-lasting immersion in water in the conditions specified by the manufacturer

STOSOWANE IKONKI USED SYMBOLS



Klasa bezpieczeństwa Safety class	Symbol Symbol	Wyjaśnienie Explanation
0	Brak None	Ochronę przed porażeniem elektrycznym stanowi izolacja podstawowa. W przypadku uszkodzenia izolacji ochronę przeciwporażeniową powinny zapewnić odpowiednio korzystne warunki środowiskowe oraz położenie urządzenia poza dotykiem bezpośrednim. Protection against electrical shock is guaranteed by the basic isolation. In case that the isolation is damaged, the anti-shock protection should be guaranteed by the appropriately favourable environmental conditions and the equipment location beyond the direct touch.
I		W urządzeniach z I klasą ochronności bezpieczeństwo zapewnione jest poprzez połączenie wszystkich czynnych przewodzących elementów z przewodem ochronnym lub bezpośrednio z uziemieniem. In the equipment of the I class protection the safety is guaranteed through connection of all active conducting elements with a protective conductor or directly with the grounding.
II		W urządzeniach z II klasą ochronności bezpieczeństwo zapewnione jest przez zastosowanie izolacji podwójnej lub wzmocnionej, której w danych warunkach środowiskowych i przy napięciu znamionowym uważa się za nie do przebicia. In the equipment of the II class protection the safety is guaranteed through the application of double or reinforced isolation, which in the given environmental conditions and at the rated voltage is considered unbreakable.
III		Ochrona przeciwporażeniowa w urządzeniach III klasy ochronności jest zapewniona przez obniżenie napięcia zasilania do wartości bezpiecznej w danych warunkach środowiskowych. The anti-shock protection in the III class equipment is guaranteed through decreasing of the supply voltage to the value which is safe in the given environmental conditions.

Temperatura barwowa Tc [K] to temperatura ciała doskonale czarnego, w której wysyła ono promieniowanie świetlne o tej samej barwie co źródło rozpatrywane. Jest to więc to obiektyw-
na miara wrażenia barwy danego źródła światła

Colour temperature Tc [K] is the temperature of a perfect radiator at which it sends visible radiation of the same colour as the colour of the examined source. This is hence an objective
measure of the colour impression of the given source of light

<2700K	Barwa żółto-biała	Yellow-white colour
2700-3300K	Barwa ciepłobiała	Warm white colour
3300-5300K	Barwa neutralna (biała)	Neutral colour (white)
>5300K	Barwa dzienna (chłodnobiała)	Daylight colour (cool white)



Trzonek to część lampy służąca do jej umocowania w oprawce, zwykle również do jej połączenia z obwodem zasilającym. Rodzaj trzonka i odpowiadającej mu oprawki zazwyczaj opisywany jest jedną lub paroma literami oraz liczbą wskazującą przybliżony wymiar trzonka w milimetrach (przeważnie średnicę lub rozstaw bolców). The cap is a part of the lamp that is used for fastening it in a socket, and usually for connecting it to a power supply system. The cap types and their corresponding sockets are usually marked with one or more letters and a number indicating the approximate cap size in millimeters (usually a diameter or a pin spacing).

Prezentujemy najczęściej spotykane rodzaje trzoneków:
The most common cap types are:

trzonki gwintowane / screw caps							
E40	E27	E14					
trzonki do lamp niskonapięciowych / caps for low-voltage lamps							
GY6.35	Gx5,3	G4	G53	GU4	Gx4		
trzonki dwubolcowe / 2-pin caps							
G24d	G23	G9	GU10	GZ10	GR8	G12	GX53
trzonki czterebolcowe / 4-pin caps							
G24q	GR10q	G10q	2G11				
trzonki do lamp dwukońców / double-ended lamp caps							
R7s	Rx-7s	G5	G13				

STOSOWANE IKONKI USED SYMBOLS



27395	kod Kanlux / Kanlux code		jednolitość barw [SDCM] / color uniformity [SDCM]		cos φ	współczynnik mocy / power factor
5902052559695	kod EAN / EAN code					
	kolor / colour			mm		długość / length
	napięcie znamionowe / rated voltage				UGR	UGR / UGR
	zasilanie świetlówek T8 LED jednostronne/ the range of humidity to which the product is adapted					oprawa ruchoma w zakresie horizontalnym / horizontally movable fitting
	moc / power					oprawa ruchoma w zakresie wertykalnym / vertically movable fitting
						oprawa stała / stationary fitting
	częstotliwość znamionowa / rated frequency					regulacja kątowa oprawy oświetleniowej [°] / angle adjustment of the lighting fixture [°]
	napięcie wejściowe / input voltage					regulacja kątowa oprawy oświetleniowej w dwóch osiach / angle adjustment of the lighting fixture in two axes
	napięcie wyjściowe / output voltage					regulacja kątowa oprawy oświetleniowej w jednej osi / angle adjustment of the lighting fixture in one axis
	prąd wyjściowy / output current					otwór montażowy / mounting hole
	prąd znamionowy / rated current					rodzaj statecznika: elektroniczny / ballast type: electronic
	In [A] In [mA] In [AX]					rodzaj statecznika: indukcyjny / ballast type: inductive
	roczne zużycie energii / annual energy consumption					rodzaj zasilania - stałonapięciowy / type of power supply - constant voltage
	ilość cykli włącz/wyłącz / number on/of switch cycles					rodzaj zasilania - stałoprądowy / type of power supply - constant current
	deklaracja równoważności dotycząca mocy / declaration of equivalence regarding power					stopień odporności na wnikanie ciał stałych i wilgoci (IP) / solids and humidity penetration protection degree (IP)
	niewymienne źródło światła / non-replaceable light source					stopień określający ochronę przed uderze- niami mechanicznymi / degree of protection against mechanical impacts
	wymienne źródło światła / replaceable light source					do zastosowania wewnątrz / for indoor use
	temperatura barwowa (Tc)/ colour temperature (Tc)					do zastosowania wewnątrz lub na zewnątrz / for indoor or outdoor use
	barwa światła / colour temperature					zgodność z normami europejskimi (CE) / compliance with European standards (CE)
	skuteczność świetlna / luminous efficiency					
						
						

STOSOWANE IKONKI USED SYMBOLS



	certifikat Zgodności potwierdzający jakość produkcji z zatwierdzonymi standardami na terytorium Unii Celnej / certificate of Conformity confirming the quality of production in accordance with approved standards on the territory of the Customs Union
	klasa ochronności przed porażeniem elektrycznym I / class of protection against electric shock I
	klasa ochronności przed porażeniem elektrycznym II / class of protection against electric shock II
	klasa ochronności przed porażeniem elektrycznym III / class of protection against electric shock III
	lampa nie jest przeznaczona do oświetlenia akcentowego / the lamp is not designed for accent lighting
	lampa jest przeznaczona do oświetlenia akcentowego / the lamp is designed for accent lighting
	możliwość montażu na powierzchniach normalnie palnych / can be mounted on normally flammable surfaces
	źródło światła w komplecie / light source included

typ źródła światła / light source type	
	AR-111
	ES-111
	COMPACT
	DD
	G9
	J-78mm
	J-118mm
	J-189mm
	J-254mm
	JDR
	METALHALIDE
	MR-11
	MR-16
	PL-L
	R39
	R50
	R63
	R80
	T1U
	T2U
	T4
	T5
	T5 LED
	T8
	MR16/PAR16

trzonek / cap	
	E14
	E27
	E40
	B22
	2G7
	2G11
	G4
	G5
	G5,3
	GY6.35
	G9
	G10q
	G12
	G13
	G23
	G24d
	G53
	GR8
	GR10q
	GU4
	GU5,3
	GU10
	GU10/G210
	Gx4
	Gx5,3
	GX53
	R7s
	Rx-7s

	rodzaj diody / LED type
	kierunek świecenia / lighting direction
	rodzaj przyłącza / type of connection
	kostka śrubowa / screw cube
	kostka przyłączeniowa / connection block
	kostka samozaciskowa / self-locking cube
	przewód zakończony wtyczką / cable with a plug
	wolne końce przewodów / free cable ends
	średnica przewodu / wire diameter
	długość przewodu / cable length
	zakres przekrojów stosowanych przewodów / range of cross-sections of cables used
	długość przewodu zasilacza zakończony wtyczką / length of the power cord terminated with a plug
	montaż / assembly
	do nabudowania na ścianie / wall-mounted
	do wbudowania w ścianę / wall recessed
	do nabudowania na suficie / ceiling-mounted
	do wbudowania w sufit / ceiling recessed
	do wbudowania w sufit lub ścianę / ceiling or wall recessed
	do nabudowania na podłożu / foundation-mounted
	do wbudowania w podłoże / foundation recessed
	do nabudowania na suficie, ścianie lub podłożu / ceiling-, wall- or foundation- mounted

	na szynie TH35 / rail TH35
	na szynie TEAR / rail TEAR
	do zawieszenia na suficie / for hanging on the ceiling
	rodzaj czujnika / type of sensor
	PIR
	micro wave
	2 x PIR
	3 x PIR
	charakterystyka wyzwalania / trigger characteristics
	czas działania czujnika / sensor operation time
	kąt działania czujnika / sensor operating angle
	zasięg czujnika / sensor range
	nastawa poziomu natężenia oświetlenia, przy którym czujnik wykrywa ruch / setting the brightness level at which the sensor detects movement
	głośność / loudness
	objętościowy przepływ powietrza [m3/h] / the volumetric air flow [m3/h]
	obrotowy silnika / engine speed
	ilość biegunów / number of poles
	1P
	2P
	3P
	4P
	liczba modułów / number of modules

ADAMO MTH-250/A	04845	277	ANTRA LED30W-NW GR	25584	272
ADAMO MTH-250/S	04841	277	ANTRA LED30W-NW-SE B	25706	272
ADAMO MTH-400/A	04846	277	ANTRA LED30W-NW-SE GR	25581	272
ADAMO MTH-400/S	04842	277	ANTRA LED50W-NW B	25707	272
ADI 350 1x3W	01440	328	ANTRA LED50W-NW GR	25585	272
ADTR 12030 B	27614	225	ANTRA LED50W-NW-SE B	25708	272
ADTR 12030 SR	27612	225	ANTRA LED50W-NW-SE GR	25582	272
ADTR 12030 W	27611	225	APO TM-3	07980	346
ADTR 6060 B	27615	225	APRILA DTL-W	26739	164
ADTR 6060 SR	27610	225	APRILA DTO-W	26738	164
ADTR 6060 W	27613	225	APUS LED AC-CW	23801	198
AGARA LED EL-14L-UP	18600	302	APUS LED AC-WW	23800	198
AGARA LED EL-19I-UP	18601	302	APUS LED CW	23107	198
AGARA LED EL-50	18602	302	APUS LED PIR CW	27371	198
AGARA LED EL-80	18604	302	APUS LED PIR WW	27370	198
AKRA CT-DS14PS/N	04785	178	APUS LED W-CW	26841	198
AKVEN LED	25720	313	APUS LED WW	23106	198
ALDO 4LED 1X120	26361	240	APUS LED W-WW	26840	198
ALDO 4LED 1X120R	26371	240	AR-111 LED SL/CW/SR	22963	70
ALDO 4LED 1X150	26362	240	AR-111 LED SL/CW/W	22961	70
ALDO 4LED 1X150R	26372	240	AR-111 LED SL/WW/SR	22962	70
ALDO 4LED 1X60	26360	240	AR-111 LED SL/WW/W	22960	70
ALDO 4LED 1X60R	26370	240	ARDEA 1030 M/ML-BI	70786	130
ALDO 4LED 2X120	26364	240	ARDEA 1030 S/ML-BI	70784	130
ALDO 4LED 2X120R	26374	240	ARDEA 1030 1/2/ML-BI	70788	130
ALDO 4LED 2X150	26365	240	ARDEA 1030 SG/ML-SR	70761	130
ALDO 4LED 2X150R	26375	240	ARDEA 1130 D/ML-BI	70782	130
ALDO 4LED 2X60	26363	240	ARDEA 1130 DG/ML-SR	70756	130
ALDO 4LED 2X60R	26373	240	AREL LED DL 10W-NW	29586	263
ALER JQ-30-B	00461	318	AREL LED DL 10W-WW	29587	263
ALER JQ-30-W	00460	318	AREL LED DL 14W-NW	29590	263
ALER MINI-W	23450	318	AREL LED DL 14W-WW	29591	263
ALGO GU10 CL-B	27030	120	AREL LED DL 20W-NW	29594	263
ALGO GU10 CL-W	27032	120	AREL LED DL 20W-WW	29595	263
ALGO GU10 CO-B	27033	120	AREL LED DL 6W-NW	29582	263
ALGO GU10 CO-W	27035	120	AREL LED DL 6W-WW	29583	263
ALGO GU10 PL-B	27036	112	AREL LED DO 10W-NW	29584	263
ALGO GU10 PL-W	27038	112	AREL LED DO 10W-WW	29585	263
ALGO GU10 PO-B	27039	112	AREL LED DO 14W-NW	29588	263
ALGO GU10 PO-W	27041	112	AREL LED DO 14W-WW	29589	263
ALIN 4LED	xxx	22 - 23	AREL LED DO 20W-NW	29592	263
ALIN LED	xxx	18 - 19	AREL LED DO 20W-WW	29593	263
ALIN LED LINE	xxx	20 - 21	AREL LED DO 6W-NW	29580	263
ALOR DSL-B	26727	184	AREL LED DO 6W-WW	29581	263
ALOR DSL-C	26728	184	ARET 1XMR16-GR	26721	167
ALOR DSL-C/M	26729	184	ARET 1XMR16-W	26720	167
ALOR DSL-W	26726	184	ARET 2XMR16-C/M	26725	167
ALOR DSO-B	26791	184	ARET 2XMR16-GR	26724	167
ALOR DTL-B	26732	184	ARET 2XMR16-W	26723	167
ALOR DTO-B	26796	184	ARGUS CT-2114-AN	00327	182
ALREN DTL-B	26754	169	ARGUS CT-2114-BR/M	00324	182
ALREN DTL-C	26755	169	ARGUS CT-2114-C	00301	182
ALREN DTL-C/M	26756	169	ARGUS CT-2114-C/M	00325	182
ALREN DTL-W	26753	169	ARGUS CT-2114-G	00300	182
ALREN R DTL-B	26757	168	ARGUS CT-2114-GM	00328	182
ALREN R DTL-W	26758	168	ARGUS CT-2114-W	00303	182
ANDER LED 60W-NW	27110	237	ARGUS CT-2115-AN	00333	182
ANTOS LED 10W-NW B	27090	274	ARGUS CT-2115-BR/M	00330	182
ANTOS LED 10W-NW-SE B	27094	274	ARGUS CT-2115-C	00305	182
ANTOS LED 20W-NW B	27091	274	ARGUS CT-2115-C/M	00331	182
ANTOS LED 20W-NW-SE B	27095	274	ARGUS CT-2115-G	00304	182
ANTOS LED 30W-NW B	27092	274	ARGUS CT-2115-GM	00334	182
ANTOS LED 30W-NW-SE B	27096	274	ARGUS CT-2115-W	00307	182
ANTOS LED 50W-NW B	27093	274	ARGUS CT-2117-BR/M	00336	182
ANTOS LED 50W-NW-SE B	27097	274	ARGUS CT-2117-C	00309	182
ANTRA LED100W-NW GR	25586	272	ARGUS CT-2117-C/M	00337	182
ANTRA LED10W-NW B	25703	272	ARGUS CT-2117-GM	00340	182
ANTRA LED10W-NW GR	25583	272	ARGUS CT-2117-W	00311	184
ANTRA LED10W-NW-SE B	25701	272	ARME LED L 5W-WW	28250	262
ANTRA LED10W-NW-SE GR	25580	272	ARME LED O 5W-WW	28251	262
ANTRA LED150W-NW GR	25587	272	ARTO 1L-SR	26610	259
ANTRA LED200W-NW GR	25700	272	ARTO 1O-SR	26613	259
ANTRA LED20W-NW B	25704	272	ARTO 2L-SR	26614	259
ANTRA LED20W-NW GR	25589	272	ARTO 3L-SR	26616	259
ANTRA LED20W-NW-SE B	25702	272	ASIL G9 W-B	27020	194
ANTRA LED20W-NW-SE GR	25588	272	ASIL G9 W-GR	27021	194
ANTRA LED30W-NW B	25705	272	ASIL G9 W-W	27022	194

ASTEN LED IP44 12W-NW	26681	196	BRAVO DRIVER 45W	28027	225
ASTEN LED IP44 15W-NW	26682	196	BRAVO DRIVER 50W	28028	225
ASTEN LED IP44 8W-NW	26680	196	BRAVO P 36W12030NW SR	28021	222-223
AVAR 6060 40W-CW	26771	232	BRAVO P 36W12030NW W	28020	222-223
AVAR 6060 40W-NW	26770	232	BRAVO P 36W6060CW W	28006	222-223
AVAR 6262 40W-NW	26773	232	BRAVO P 36W6060NW SR	28001	222-223
AVAR 6262 40W-WW	26774	232	BRAVO P 36W6060NW W	28000	222-223
AVAR DALI SET 40W	28512	232	BRAVO P 45W6060NW SR	28009	222-223
AVIA MTH-478/250W-B	04013	276	BRAVO P 45W6060NW W	28008	222-223
AVIA MTH-478/400W-B	04011	276	BRAVO PU28W3060NW W	28551	222-223
AWAN LED C-W	26491	215	BRAVO PU36W12030NW W	28550	222-223
AWAN LED S-W	26490	215	BRAVO PU36W6060NW SR	28003	222-223
AZ-10A	22371	326	BRAVO PU36W6060NW W	28002	222-223
BART DL-125	28800	286	BRAVO PU36W6262NW W	28024	222-223
BART DL-160	28801	286	BRAVO S 40W12030NW SR	28023	224-225
BART EL-135	07079	285	BRAVO S 40W12030NW W	28022	224-225
BART EL-140	07083	285	BRAVO S 40W6060CW W	28016	224-225
BART EL-160	07081	285	BRAVO S 40W6060NW SR	28011	224-225
BART EL-235	07080	285	BRAVO S 40W6060NW W	28010	224-225
BART EL-260	07082	285	BRAVO S 50W6060NW SR	28019	224-225
BASK CTC-5514-MPC/N	02814	187	BRAVO S 50W6060NW W	28018	224-225
BASK CTC-5514-SN/N	02816	187	BRAVO S/P GRIP 12030	28501	225
BASK CTC-5515-MPC/N	02804	187	BRAVO S/P GRIP 60-62	28500	225
BASK CTC-5515-SN/N	02806	187	BRAVO SU40W6060NW SR	28013	224-225
BERG DL-35L	07171	294	BRAVO SU40W6060NW W	28012	224-225
BERG DL-35O	07170	296	BR-GZ10	72369	347
BIGGE LED 42W-NW-L	28723	248	BS-1 4-22W	07180	334
BIGGE LED 42W-NW-O	28721	248	BS-2 4-65W	07181	334
BIGGE LED 42W-WW-L	28722	248	CANTA CTX-DS20	19610	189
BIGGE LED 42W-WW-O	28720	248	CARSA V2LED 12W-NW-SN	27210	267
BILO 3W T SMD E14-WW	23040	54	CARSA V2LED 12W-NW-W	28948	267
BILO 3W T SMD E27-WW	23041	54	CARSA V2LED 18W-NW-SN	27211	267
BILO 5W T SMD E14-WW	23042	54	CARSA V2LED 18W-NW-W	28949	267
BILO 5W T SMD E27-WW	23043	54	CDH/CL 28W E14	18440	98
BILO 6,5W T SMDE14-NW	23423	54	CDH/CL 42W E14	18441	98
BILO 6,5W T SMDE14-WW	23422	54	CEL CTC-5519-C/M	02755	179
BILO 6,5W T SMDE27-NW	23421	54	CEMIN DTL-GR	27230	166
BILO 6,5W T SMDE27-WW	23420	54	CHIRO GU10 DTL-B	29313	147
BILO HI 8W E14-NW	26763	55	CHIRO GU10 DTL-W	29312	147
BILO HI 8W E14-WW	26762	55	CHIRO GU10 DTO-B	29311	147
BILO HI 8W E27-NW	26765	55	CHIRO GU10 DTO-W	29310	147
BILO HI 8W E27-WW	26764	55	CIRCO LED 12VDC 0-10W	24240	328
BISO LED EL 8W-GR	29260	290	CIRCO LED 12VDC 0-15W	24241	328
BISO LED EL 8W-W	29261	290	CLIPS BRAVO S/P 12030	28503	225
BL-118H-EVG	70480	333	CLIPS BRAVO S/P 60-62	28502	225
BL-136H-EVG	70481	333	COLIE DTO-AL.	26742	170
BL-158H-EVG	70482	333	COLIE DTO-B	26743	170
BL-218H-EVG	70483	333	COLIE DTO-G	26741	170
BL-236H-EVG	70484	333	COLIE DTO-GR	26744	170
BL-258H-EVG	70485	333	COLIE DTO-W	26740	170
BL-3-4x14H-EVG	8240	333	CONNECT C/D/E/I	26563	87, 88, 89, 93
BL-418H-EVG	70486	333	CONNECT C/D/E/I	26563	87, 88, 89, 93
BLINGO LED36W 6060 NW	29820	226	CONNECT C/D/E/I	26597	87, 88, 89, 93
BLINGO LED48W 6060 NW	29821	226	CONNECT C/D/E/I	26597	87, 88, 89, 93
BOA IN C1 302M AT	27862	355	CONNECT-L B	26604	86
BOA IN RC1 302M ST	27860	355	CONNECT-L C	26562	86
BOA IN RM1 301M AT	27822	355	CONNECTOR 8	19030	81
BOA IN RM1 301M ST	27820	355	CONNECTOR 8-CP	19032	81
BOA IN RM2 302 M AT	27403	355	CONNECTOR 8-CPC	19033	81
BOA IN RM2 302M ST	27821	355	CONNECTOR RGB 10	19038	82
BONIS DSL-C	28703	153	CONNECTOR RGB 10-CP	19036	82
BONIS DSL-W	28702	153	CONNECTOR RGB 10-CPC	19037	82
BONIS DSO-C	28701	153	CONTROLLER LED RGB-RF	22140	84
BONIS DSO-W	28700	153	CONTROLLER RGB-IR20	18960	84
BORD DLP-250-AL.	22553	116	CORDES	25530	113
BORD DLP-250-B	22555	116	CROTO LED-GR-L	22770	291
BORD DLP-250-W	22554	116	CYBER TM-6	01016	327
BORD DLP-350-AL.	25802	116	CYDEA D	25551	219
BORD DLP-350-W	25800	116	CYDEA F	25550	219
BORD DLP-50-AL.	22550	116	CYDEA P	25552	114
BORD DLP-50-B	22552	116	CYKLON WKK-EOL100	70910	337
BORD DLP-50-W	22551	116	CYKLON WKK-EOL100B	70911	337
BRAVO DALI SET 36W	28508	225	CYKLON WKK-EOL100HT	70936	337
BRAVO DALI SET 45W	28507	225	CYKLON WKK-EOL100P	70937	337
BRAVO DRIVER 28W	28029	225	CYKLON WKK-EOL100T	70938	337
BRAVO DRIVER 36W	28025	225	CYKLON WKK-EOL120	70915	337
BRAVO DRIVER 40W	28026	225	CYKLON WKK-EOL120B	70916	337

CYKLON WKK-EOL120HT	70941	337	ENALI EL-30 B	28765	138
CYKLON WKK-EOL120P	70942	337	ENALI EL-30 W	28764	138
CYKLON WKK-EOL120T	70943	337	ENALI EL-41 B	28769	138
CYKLON WKK-EOL150	70920	337	ENALI EL-41 W	28768	138
CYKLON WKK-EOL150B	70921	337	ES-111 LED SL/CW/SR	22973	71
CYKLON WKK-EOL150P	70947	337	ES-111 LED SL/CW/W	22971	71
CYKLON WKK-EOL150T	70948	337	ES-111 LED SL/WW/SR	22972	71
DABA LED ECO DL-100	19061	243	ES-111 LED SL/WW/W	22970	71
DABA N LED SMD DL-16W	19062	243	ESG LED 9W GX53-CW	22424	76
DABA N LED SMD DL-22W	19063	243	ESG LED 9W GX53-NW	22423	76
DALLA CT-DTL50-B	22433	157	ESG LED 9W GX53-WW	22422	76
DALLA CT-DTL50-W	22431	157	ETISSA D20 GR	27000	110
DALLA CT-DTO50-B	22432	157	EURO MTH-250-16PC	07860	281
DALLA CT-DTO50-W	22430	157	EURO MTH-250-21AL	07864	281
DANERA CT-DTL35-SC	08666	185	EURO MTH-250-22PC	07862	281
DARSA EL-135	19122	305	EURO MTH-400-16PC	07861	281
DARSA EL-135L-UP	19120	305	EURO MTH-400-21AL	07865	281
DARSA EL-235A	19123	305	EURO MTH-400-22PC	07863	281
DARSA EL-235T-UP	19121	305	EVELI EL-10	29100	142
DB-FF6 12/24VDC	23572	211	EVELI EL-2I	29101	142
DD-16W/4P 3500K	12660	103	EVELI EL-30	29102	142
DD-21W/4P 3500K	12661	103	EVELI EL-4I	29103	142
DD-28W/4P 3500K	12662	103	EVIT CT-DTL50-AL.	18560	172
DD-38W/4P 3500K	12663	103	EVIT CT-DTO50-AL.	18561	172
DELE AL-204-C/M	00913	185	FL MASTER LED 100W-NW	28490	270
DELE AL-205-C/M	00923	185	FL MASTER LED 140W-NW	28491	270
DIMGO 105	28830	332	FL MASTER LED 220W-NW	28492	270
DINO CTX-DS02G/B-C	02576	190	FLM LED 100W-NW-60D	28520	271
DIVISO W 3	26091	343	FLM LED 140W-NW-60D	28522	271
DORA LED-J01	04680	292	FLM LED 220W-NW-60D	28524	271
DORTO LED COB-20	22630	268	FLM LED100W-NW110/150	28521	271
DORTO LED COB-40	22631	268	FLM LED140W-NW110/150	28523	271
DOSAN LED B	26691	213	FLM LED220W-NW110/150	28525	271
DOSAN LED W	26690	213	FOGLER DL-2400	18120	250
DRIFT LED 0-6W	18040	329	FOGLER LED 14W-NW	18121	247
DRIFT LED 3-18W	08550	329	FOLLO LED B	28791	212
DRIFT LED F 0-18W	18042	211	FOLLO LED W	28790	212
DRIVE LED 0-15W 12VDC	23860	329	FORRO LED EL 8W-GR	29250	290
DUCE AL-DTL50	19950	119	FORRO LED EL 8W-W	29251	290
DUCE AL-DTO50	19951	119	FRANCO 15LED SMD KT-B	22341	212
DUN 4,5W T SMD E14-NW	23381	48	FRANCO 15LED SMD KT-W	22340	212
DUN 4,5W T SMD E14-WW	23380	48	FULLED GU10-3,3W-CW	26035	58
DUN 6,5W T SMD E14-NW	23431	48	FULLED GU10-3,3W-NW	26034	58
DUN 6,5W T SMD E14-WW	23430	48	FULLED GU10-3,3W-WW	26033	58
DUN HI 8W E14-NW	26761	49	FUTURIO LED	xxx	28 - 29
DUN HI 8W E14-WW	26760	49	G9 GLASS LED2W-CW	26631	66
EBRI LED 17W E27-NW	29021	42	G9 GLASS LED2W-WW	26630	66
EBRI LED 17W E27-WW	29020	42	G9-20W STAR	18420	99
EBRI LED 21W E27-NW	29023	42	G9-33W STAR	18421	99
EBRI LED 21W E27-WW	29022	42	G9-48W STAR	18422	99
ELIOT ZW3-L500P-B	00620	275	G9-60W STAR	18423	99
ELLI CTX-DS20	18410	189	GARTO LED EL 8W-GR	29270	291
ELNER LED 15W-NW-B	27561	288	GARTO LED EL 8W-W	29271	291
ELNER LED 15W-NW-SE-B	27563	288	GAVI CT-2116B-BR/M	00814	208
ELNER LED 8W-NW-B	27560	288	GAVI CT-2116B-C	00811	208
ELNER LED 8W-NW-SE-B	27562	288	GAVI CT-2116B-C/M GAVI	00815	208
ELNIS L A	27809	155	GAVI CT-2116B-W GAVI	00810	208
ELNIS L A/C	27808	155	GAVI LED18 SMD-WW-C/M	19761	209
ELNIS L A/W	27807	155	GIO LED G4 FL-NW	22663	68
ELNIS L B/G	27810	155	GIO LED G4 FL-WW	22662	68
ELNIS L C/A	27812	155	GIO LED G9-NW	22661	66
ELNIS L C/W	27811	155	GIO LED G9-WW	22660	66
ELNIS L W	27804	155	GIVRO LED-BL 50M	08631	96
ELNIS L W/A	27805	155	GIVRO LED-CW 50M	08630	96
ELNIS L W/C	27806	155	GIVRO LED-CN 50M	08633	96
ELNIS S A/C	27803	154	GIVRO LED-RE 50M	08632	96
ELNIS S A/W	27802	154	GIVRO LED-WW 50M	08642	96
ELNIS S W	27800	154	GIVRO LED-Y 50M	08634	96
ELNIS S W/A	27801	154	GIVRO PR SET	08637	96
ELSE CT-2116C-C	00821	192	GIVRO-90L	08636	96
ELSE CT-2116C-C/M	00825	192	GIVRO-I	08639	96
ENALI EL-10 B	28761	138	GIVRO-PEND	08640	96
ENALI EL-10 W	28760	138	GIVRO-T	08641	96
ENALI EL-2I B	28763	138	GIVRO-X	08635	96
ENALI EL-2I W	28762	138	GIVRO-Z	08638	96
ENALI EL-3I B	28767	138	GLASO EL-10	19640	143
ENALI EL-3I W	28766	138	GLASO EL-2I	19641	143

GLASO EL-31	19642	143	HORN CTC-3114-SN/G	02820	188
GLASO EL-30	19644	143	HORN CTC-3114-SN/N	02821	188
GLASO EL-41	19643	143	HORN CTC-3115-GM/N	02834	188
GLH/CL 100W E27	18454	97	HORN CTC-3115-PS/G	02832	188
GLH/CL 28W E27	18450	97	HORN CTC-3115-SN/G	02830	188
GLH/CL 42W E27	18451	97	HORN CTC-3115-SN/N	02831	188
GLH/CL 52W E27	18452	97	IDAVA 25	23510	312
GLH/CL 70W E27	18453	97	IDAVA 35	23511	312
GLORIA TL3011-18W	00510	206	IDAVA 47	23512	312
GLORIA TL3011-30W	00511	206	IDO 4,5W T SMD E14-NW	23383	50
GORD DLP 250-B	25474	118	IDO 4,5W T SMD E14-WW	23382	50
GORD DLP 250-W	25473	118	IDO 6,5W T SMD E14-NW	23491	50
GORD DLP 50-AL	25472	118	IDO 6,5W T SMD E14-WW	23490	50
GORD DLP 50-B	25471	118	IMBER LED CW	23521	192
GORD DLP 50-W	25470	118	IMBER LED NW	23520	192
GORDO LED14 SMD-L	22051	296	IMINES DSL-W	29030	152
GORDO LED14 SMD-O	22050	296	IMINES DSO-W	29031	153
GORI 50	29002	303	IMOE DSL50	26071	157
GORI 80	29003	303	IMOE DSO50	26070	157
GORI EL 135 D	29000	303	INES 7061N	70525	253
GORI EL 235 D	29001	303	INVO OP 107-L-GR	29173	299
GOVIK DSO-B	29236	149	INVO OP 47-L-GR	29171	299
GOVIK DSO-W	29235	149	INVO OP 77-L-GR	29172	299
GP-2	70513	343	INVO OP EL-53-L-GR	29170	299
GRAVME C G/HY	24281	111	INVO TR 107-O-GR	29177	300
GRAVME O G/HY	24280	111	INVO TR 47-O-GR	29175	300
GRIBLO LED SMD-NW	18131	313	INVO TR 77-O-GR	29176	300
GRIP GP/S	04862	344	INVO TR EL-53-O-GR	29174	300
GRIP W/US	04863	344	IQ-LED A60 10,5W-CW	27278	34
GWEN CT-DTL50-B	18530	172	IQ-LED A60 10,5W-NW	27277	34
GWEN CT-DT050-B	18531	172	IQ-LED A60 10,5W-WW	27276	34
HANDLE A	19190	85	IQ-LED A60 14W-CW	27281	34
HANDLE B/F	26596	86	IQ-LED A60 14W-NW	27280	34
HANDLE C/D/E/I	26563	87, 88, 89, 93	IQ-LED A60 14W-WW	27279	34
HANDLE C/D/E/I	26597	87, 88, 89, 93	IQ-LED A60 5,5W-CW	27272	34
HANDLE G	26598	91	IQ-LED A60 5,5W-NW	27271	34
HANDLE H	26599	92	IQ-LED A60 5,5W-WW	27270	34
HANDLE J/K	26595	94, 95	IQ-LED A60 9W-CW	27275	34
HANDLE SIDE H	26600	92	IQ-LED A60 9W-NW	27274	34
HAXA-DSO POWER LED-B	08103	193	IQ-LED A60 9W-WW	27273	34
HB MASTER LED 100W	28530	278	IQ-LED A67 17,5W-CW	27314	35
HB MASTER LED 150W	28531	278	IQ-LED A67 17,5W-NW	27313	35
HB MASTER LED 200W	28532	278	IQ-LED A67 17,5W-WW	27312	35
HB PRO LED 100W-NW	27150	280	IQ-LED A67 19W-CW	27317	35
HB PRO LED 150W-NW	27151	280	IQ-LED A67 19W-NW	27316	35
HB REF 15 AL	27152	280	IQ-LED A67 19W-WW	27315	35
HB REF 17 AL	27153	280	IQ-LED C37E14 5,5W-CW	27296	45
HBM BRACKET 100/150W	28543	279	IQ-LED C37E14 5,5W-NW	27295	45
HBM BRACKET 200W	28544	279	IQ-LED C37E14 5,5W-WW	27294	45
HBM GRID 100/150W	28545	279	IQ-LED C37E14 7,5W-CW	27299	45
HBM GRID 200W	28546	279	IQ-LED C37E14 7,5W-NW	27298	45
HBM LENS 60D 100/150W	28537	279	IQ-LED C37E14 7,5W-WW	27297	45
HBM LENS 60D 200W	28540	279	IQ-LED G45E14 5,5W-CW	27302	51
HBM LENS 90D 100/150W	28538	279	IQ-LED G45E14 5,5W-NW	27301	51
HBM LENS 90D 200W	28541	279	IQ-LED G45E14 5,5W-WW	27300	51
HBM PC 100D 100/150W	28539	279	IQ-LED G45E14 7,5W-CW	27308	51
HBM PC 100D 200W	28542	279	IQ-LED G45E14 7,5W-NW	27307	51
HBM REF ALU100/150W	28533	279	IQ-LED G45E14 7,5W-WW	27306	51
HBM REF ALU200W	28534	279	IQ-LED G45E27 5,5W-CW	27305	51
HBM REF PC100/150W	28535	279	IQ-LED G45E27 5,5W-NW	27304	51
HBM REF PC200W	28536	279	IQ-LED G45E27 5,5W-WW	27303	51
HERMI 7063NB	70524	255	IQ-LED G45E27 7,5W-CW	27311	51
HERON LED B	27600	215	IQ-LED G45E27 7,5W-NW	27310	51
HERON LED W	27601	215	IQ-LED G45E27 7,5W-WW	27309	51
HLDR-E14	02170	347	IQ-LED GU10 5W-CW	29805	56
HLDR-E14/GU10	08851	352	IQ-LED GU10 5W-NW	29804	56
HLDR-E14-F	02173	348	IQ-LED GU10 5W-WW	29803	56
HLDR-E27	02160	348	IQ-LED GU10 7W S3-CW	29808	56
HLDR-E27/GU10	08850	352	IQ-LED GU10 7W S3-NW	29807	56
HLDR-E27-D	02162	349	IQ-LED GU10 7W S3-WW	29806	56
HLDR-E27-F	02161	349	IQ-LED GU10 7W-CW	29811	56
HLDR-G9	08220	350	IQ-LED GU10 7W-NW	29810	56
HLDR-GX5.3	72109	350	IQ-LED GU10 7W-WW	29809	56
HLDR-GZ10	00402	351	IQ-LEDDIM A60 15W-CW	27293	36
HLDR-R7S	00405	351	IQ-LEDDIM A60 15W-NW	27292	36
HORN CTC-3114-GM/N	02824	188	IQ-LEDDIM A60 15W-WW	27291	36
HORN CTC-3114-PS/G	02822	188	IQ-LEDDIM A60 5,5W-CW	27284	36

INDEKS ALFABETYCZNY
ALPHABETICAL INDEX

IQ-LEDDIM A60 5,5W-NW	27283	36	JC-5W G4	10720	100
IQ-LEDDIM A60 5,5W-WW	27282	36	JURBA DL-218L	08981	250
IQ-LEDDIM A60 8,5W-CW	27287	36	JURBA DL-218O	08980	250
IQ-LEDDIM A60 8,5W-NW	27286	36	KANTI V2LED 12W-NW-SN	27212	267
IQ-LEDDIM A60 8,5W-WW	27285	36	KANTI V2LED 12W-NW-W	28950	267
IQ-LEDDIM A6012,5W-CW	27290	36	KANTI V2LED 18W-NW-SN	27213	267
IQ-LEDDIM A6012,5W-NW	27289	36	KANTI V2LED 18W-NW-W	28951	267
IQ-LEDDIM A6012,5W-WW	27288	36	KASSI G9 L-W	27010	195
IQ-LEDIM GU10 6,5W-CW	29814	57	KASSI G9 O-W	27011	195
IQ-LEDIM GU10 6,5W-NW	29813	57	KATRO N LED 24W-WW-SR	25824	265
IQ-LEDIM GU10 6,5W-WW	29812	57	KATRO V2LED 12W-NW-SN	27214	265
ISTI LED B	27361	213	KATRO V2LED 12W-NW-SR	28939	265
ISTI LED W	27360	213	KATRO V2LED 12W-NW-W	28940	265
IT-1/10-B	01257	364	KATRO V2LED 12W-WW-W	28941	265
IT-1/20-B	01271	364	KATRO V2LED 18W-NW-SN	27215	265
IT-1/20-BL	01275	364	KATRO V2LED 18W-NW-SR	28942	265
IT-1/20-GN	01274	364	KATRO V2LED 18W-NW-W	28943	265
IT-1/20-MIX	01283	364	KATRO V2LED 18W-WW-W	28944	265
IT-1/20-RE	01273	364	KATRO V2LED 24W-NW-SN	27216	265
IT-1/20-W	01276	364	KATRO V2LED 24W-NW-W	28945	265
IT-1/20-Y	01272	364	KATRO V2LED 6W-NW-SN	27217	265
IT-1/20-Y/GN	01277	364	KATRO V2LED 6W-NW-W	28946	265
iTECH C1 302 M AT 2W	27053	354	KATRO V2LED 6W-WW-W	28947	265
iTECH C1 302 M ST W	27382	354	KIRA DL-75B	07900	251
iTECH F2 105 M ST W	27383	354	KRALA CORD-2M	28275	233
iTECH M2 302 AT	27050	354	KRALA LED 45W NW	28270	233
iTECH M2 302 M ST W	27380	354	KRALA PLUG-1M	28271	233
iTECH M5 105 M ST W	27381	354	KRALA PP-0,35M	28274	233
iTECH M5 305 AT	27052	354	KRALA PP-1M	28273	233
iTECHF1302MATW	27635	354	KRALA PR-I	28272	233
iTECHF1302MSTW	27869	354	KRALA SENSOR	28276	233
iTECHF2105MATW	27638	354	LARITO EL-1L-B	28771	136
iTECHM2102MCOLDATW	27620	354	LARITO EL-1L-W	28770	136
iTECHM2102MCOLDSTW	27823	354	LARITO EL-2I-B	28773	136
iTECHM5105MATW	27622	354	LARITO EL-2I-W	28772	136
iTECHM5105MCOLDATW	27623	354	LARITO EL-3I-B	28775	136
iTECHM5105MCOLDSTW	27826	354	LARITO EL-3I-W	28774	136
iTECHM5305MSTW	27825	354	LARITO EL-4I-B	28779	136
IVIAN LED 4,5W SN-NW	25783	261	LARITO EL-4I-W	28778	136
IVIAN LED 4,5W SN-WW	25781	261	LARITO EL-4L-B	28777	136
IVIAN LED 4,5W W-NW	25782	261	LARITO EL-4L-W	28776	136
IVIAN LED 4,5W W-WW	25780	261	LART EL-160-GR	29832	284
IVRI DTO-W	26736	166	LART EL-260-GR	29833	284
J-1000W 189MM	10418	101	LAURIN EL-10 B	29121	134
J-120W 118MM STAR	08500	101	LAURIN EL-10 W	29120	134
J-120W 78MM STAR	08491	101	LAURIN EL-2I B	29123	134
J-1500W 254MM	10419	101	LAURIN EL-2I W	29122	134
J-160W 118MM STAR	08501	101	LAURIN EL-3I B	29125	134
J-230W 118MM STAR	08502	101	LAURIN EL-3I W	29124	134
J-400W 118MM STAR	08503	101	LAURIN EL-3O B	29127	134
J-80W 78MM STAR	08490	101	LAURIN EL-3O W	29126	134
JASMIN 270-W	23123	128	LAURIN EL-4O B	29129	134
JASMIN 270-W/M	23126	128	LAURIN EL-4O W	29128	134
JASMIN 270-WE	23120	128	LED12 SMD G4-WW	08951	69
JASMIN 370-A	29200	128	LED15 C MR16-CW-B	22204	63
JASMIN 370-W	23124	128	LED15 C MR16-WW-B	22203	63
JASMIN 370-W/M	23127	128	LEDS SET B-SE DBL	26325	83
JASMIN 370-W/M	23121	128	LEDS SET B-SE SGL	26324	83
JASMIN 470-A	23129	128	LEDS SET S-DIM IR	26320	83
JASMIN 470-GR	23759	128	LEDS SET S-DIM TS	26321	83
JASMIN 470-W	23125	128	LEDS SET W-SE ACCU	26322	83
JASMIN 470-W/M	23128	128	LEDS SET W-SE BTRY	26323	83
JASMIN 470-WE	23122	128	LEDS-B 4.8W/M IP00-CW	24518	80
JASMIN 470-W-H	23752	128	LEDS-B 4.8W/M IP00-NW	24517	80
JASMIN A-W	29201	128	LEDS-B 4.8W/M IP00-WW	24516	80
JASMIN W/M-W	23758	128	LEDS-B 4.8W/M IP54-CW	24512	80
JASMIN WE-W	23756	128	LEDS-B 4.8W/M IP54-NW	24511	80
JASMIN W-W	23757	128	LEDS-B 4.8W/M IP54-WW	24510	80
JC-10W G4	10722	100	LEDS-B 4.8W/M IP65-CW	24515	80
JC-10W4/EK BASIC	10432	100	LEDS-B 4.8W/M IP65-NW	24514	80
JC-20W G4	10724	100	LEDS-B 4.8W/M IP65-WW	24513	80
JC-20W GY6.35	10730	100	LEDS-B 7.2W/M IP00RGB	24530	82
JC-20W4/EK BASIC	10433	100	LEDS-B 7.2W/M IP54RGB	24532	82
JC-35W G4	10726	100	LEDS-B 7.2W/M IP65RGB	24531	82
JC-35W GY6.35	10732	100	LEDS-P 10W/M IP00 CW	24121	81
JC-35W4/EK BASIC	10434	100	LEDS-P 10W/M IP00 WW	24120	81
JC-50W GY6.35	10734	100	LEDS-P 10W/M IP54 CW	24123	81

LEDS-P 10W/M IP54 WW	24122	81	MAH-LED N 20W-NW/PC	22603	234
LEDS-P 4W/M IP00-CW	24011	81	MAH-LED N 40W-NW/PC	22604	234
LEDS-P 4W/M IP00-WW	24010	81	MAH-LED N 50W-NW/PC	22605	234
LEDS-P 4W/M IP54-CW	24013	81	MANGO KF-FBG-20A 25M	04395	342
LEDS-P 4W/M IP54-WW	24012	81	MANGO KF-FBG-23A 40M	04396	342
LICA LED-J04A	04684	292	MANGO KF-FBG-23A 50M	04397	342
LINAR LED CW	23113	202	MARC DL-60	07015	251
LINAR LED WW	23112	202	MARID JQ-L	08910	319
LINDA LED-J02	04681	292	MARIN CT-S80-AB	04710	181
LINER LED 18W-NW	27260	239	MARIN CT-S80-C	04703	181
LINER LED 36W-NW	27261	239	MARIN CT-S80-SN	04704	181
LINER LED 45W-NW	27262	239	MATEO DLP-150-GR	04960	258
LINUS LED 4W-NW	27590	206	MATEO DLP-250-GR	04961	258
LINUS LED 7W-NW	27591	206	MATEO DLP-350-GR	04962	258
LINUS LINK	14977	206	MEBA 4LED 2X120 OP PS	26964	242
LIRIA LED CW	23115	201	MEBA 4LED 2X120 PS	26961	242
LIRIA LED WW	23114	201	MEBA 4LED 2X150 OP PS	26965	242
LIRIA LED W-WW	26844	201	MEBA 4LED 2X150 PS	26962	242
LITEN LED 6W-NW	25561	262	MEBA 4LED 2X60 OP PS	26963	242
LITEN LED 6W-WW	25560	262	MEBA 4LED 2X60 PS	26960	242
LITEN LED 8W-NW	25563	262	MERA LED 10W NW	29211	204
LITEN LED 8W-WW	25562	262	MERA LED 15W NW	29212	204
LUGEA 28L-UP	23530	309	MERA LED 20W NW	29213	204
LUGEA 31L-UP-SE	23531	309	MERA LED 5W NW	29210	204
LUGEA 50	23532	309	MERA LED PP	29214	204
LUGEA 80	23533	309	MERA PP	04733	205
LUNATI GU10 B	29041	115	MERA TL-13/2700K	08302	205
LUNATI GU10 W	29040	115	MERA TL-13/4000K	04731	205
LUNGA 3 3G1.0X1.4M	25950	338	MERA TL-21/2700K	08303	205
LUNGA 3 3G1.0X3M	26500	338	MERA TL-21/4000K	04732	205
LUNGA 3 3G1.0X5M	26501	338	MERA TL-8/2700K	08301	205
LUNGA 4 3G1.0X1.4M	25951	338	MERA TL-8/4000K	04730	205
LUNGA 4 3G1.0X3M	26502	338	MERGE ADJ-O	23451	323
LUNGA 4 3G1.0X5M	26503	338	MERGE JQ-L	07690	320
LUNGA 5 3G1.0X1.4M	25952	338	MERGE JQ-O	07691	322
LUNGA 5 3G1.0X3M	26504	338	MERGE MW-L	23453	323
LUNGA 5 3G1.0X5M	26505	338	MERIL DLP-250-W	26481	168
LUNGA 6 3G1.0X1.4M	25953	338	MERIL DLP-50-W	26480	168
LUNGA 6 3G1.0X3M	26506	338	MERSA 300-B/M	29050	127
LUNGA 6 3G1.0X5M	26507	338	MERSA 300-W/M	25675	127
LUNGA S3 3G1.0X1.4M	25954	339	MERSA 380-B/M	29051	127
LUNGA S3 3G1.0X3M	26508	339	MERSA 380-W/M	25678	127
LUNGA S3 3G1.0X5M	26509	339	MGH/CL 28W E14	24611	98
LUNGA S4 3G1.0X1.4M	25955	339	MGH/CL 28W E27	24610	98
LUNGA S4 3G1.0X3M	26510	339	MGH/CL 42W E14	24613	98
LUNGA S4 3G1.0X5M	26511	339	MGH/CL 42W E27	24612	98
LUNGA S5 3G1.0X1.4M	25956	339	MHE-250W/4200K	12755	106
LUNGA S5 3G1.0X3M	26512	339	MHE-400W/4200K	12756	106
LUNGA S5 3G1.0X5M	26513	339	MILE 7041S	14613	254
LUNGA S6 3G1.0X1.4M	25957	339	MILENO EL-10 ASR-AN	29111	132
LUNGA S6 3G1.0X3M	26514	339	MILENO EL-10 B-AG	29110	132
LUNGA S6 3G1.0X5M	26515	339	MILENO EL-21 ASR-AN	29115	132
LUNI MAX E27 LED-WW	22572	44	MILENO EL-21 B-AG	29114	132
LUNI PRO E27 LED-WW	22571	44	MILENO EL-31 ASR-AN	29117	132
LUNIO DTO-W	29230	152	MILENO EL-31 B-AG	29116	132
LUTO CTX-DS02B-AB	02584	175	MILENO EL-30 ASR-AN	29113	132
LUTO CTX-DS02B-C	02581	175	MILENO EL-30 B-AG	29112	132
LUTO CTX-DS02B-C/M	02583	175	MILENO EL-41 ASR-AN	29119	132
LUTO CTX-DS02B-W	02580	175	MILENO EL-41 B-AG	29118	132
LUTO CTX-DT02B-AB	02594	175	MILO 7040T	70522	254
LUTO CTX-DT02B-C	02591	175	MILO 7040T/P	70523	254
LUTO CTX-DT02B-C/M	02593	175	MINI BORD DLP-50-B	28783	148
LUTO CTX-DT02B-W	02590	175	MINI BORD DLP-50-W	28782	148
MAGRA EL-135	18010	286	MINI GORD DLP-50-B	28781	148
MAGRA EL-235	18011	286	MINI GORD DLP-50-W	28780	148
MAH PLUS-118-ABS/PC	18515	236	MODv2 12W LED-NW	29301	77
MAH PLUS-136-ABS/PC	18519	236	MODv2 12W LED-WW	29300	77
MAH PLUS-136-ABS/PS	18518	236	MODv2 19W LED-NW	29303	77
MAH PLUS-158-ABS/PC	18523	236	MODv2 19W LED-WW	29302	77
MAH PLUS-218-ABS/PC	18517	236	MOLI EL-10	07085	140
MAH PLUS-218-ABS/PS	18516	236	MOLI EL-21	07086	140
MAH PLUS-236/4LED/PC	22800	235	MOLI EL-30	07087	140
MAH PLUS-236-ABS/PC	18521	236	MOLI EL-41	07088	140
MAH PLUS-236-ABS/PS	18520	236	MORO DL-35	04870	297
MAH PLUS-258/4LED/PC	22801	235	MORTA AR/ES L-B	27963	160
MAH PLUS-258-ABS/PC	18525	236	MORTA AR/ES O-B	27961	160
MAH PLUS-258-ABS/PS	18524	236	MORTA AR/ES O-SR	27960	160

MORTA B CT-DSL50-B	22110	163	ONTEC C C1 102M AT	27684	359
MORTA B CT-DSL50-SR	22112	163	ONTEC C C1 102M ST	27902	359
MORTA B CT-DSO50-B	22116	163	ONTEC C M2 102M AT	27672	359
MORTA B CT-DSO50-SR	22117	163	ONTEC C M2 102M ST	27838	359
MORTA CT-DSL250-B	19360	161	ONTEC C M2 302M AT	27673	359
MORTA CT-DSL250-SR	19362	161	ONTEC C M2 302M ST	27839	359
MORTA CT-DSL50-B	18510	161	ONTEC G EIB 101 M ST	27394	359
MORTA CT-DSL50-SR	18512	161	ONTEC G EIB 101M AT	27750	359
MORTA CT-DSO50-B	19440	161	ONTEC G EIB 301M AT	25435	359
MORTA CT-DSO50-SR	19442	161	ONTEC G EIB 301M ST	27395	359
MORTA CT-DTL50-B	26719	162	ONTEC R C1 102 M ST	27738	358
MORTA CT-DTL50-SR	26718	162	ONTEC R C1 102 M ST/W	27392	358
MORTA CT-DTO50-B	26717	162	ONTEC R C1 302 M ST/W	27393	358
MORTA CT-DTO50-SR	26716	162	ONTEC R C1 302M AT	27739	358
MORTA OCT-B	26715	164	ONTEC R M2 102 M ST/W	27390	358
MORTA OCT-SR	26714	164	ONTEC R M2 102M AT	27730	358
NAVI CTX-DS10-AB	04693	174	ONTEC R M2 302 M ST/W	27391	358
NAVI CTX-DS10-B	25990	174	ONTEC R M2 302M AT	27731	358
NAVI CTX-DS10-C	04694	174	ONTEC R M5 105M AT	27732	358
NAVI CTX-DS10-SN	04695	174	ONTEC R M5 105M ST	27850	358
NAVI CTX-DT10-AB	02554	174	ONTEC S C1 302M AT	27652	356
NAVI CTX-DT10-B	25991	174	ONTEC S C1 302M ST	27880	356
NAVI CTX-DT10-C	02551	174	ONTEC S M1 301 M AT	27054	356
NAVI CTX-DT10-C/M	02553	174	ONTEC S M1 301 M ST	27396	356
NAVI CTX-DT10-W	02550	174	ONTEC S M1 301M ST IP44	27920	356
NESTA DSL-B	26746	171	ONTEC S M1U 301M MST IP44	27944	356
NESTA DSL-C	26747	171	ONTEC S M2 102 M AT	27646	356
NESTA DSL-C/M	26748	171	ONTEC S M2 102 M AT	27057	356
NESTA DSL-W	26745	171	ONTEC S M2 102M ST	27827	356
NESTA DTL-B	26750	171	ONTEC S M2 302 M COLD AT	27056	356
NESTA DTL-C	26751	171	ONTEC S M2 302M AT	27647	356
NESTA DTL-C/M	26752	171	ONTEC S M2 302M COLD ST	27831	356
NESTA DTL-W	26749	171	ONTEC S M2 302M ST	27828	356
NIFO LED 14W E27-WW-W	26050	78	ONTEC S M5 105M AT	27648	356
NIFO LED 20W E27-WW-W	26052	78	ONTEC S M5 105M ST	27829	356
NIFO LED 22W E27-WW-W	26054	78	ONTEC S M5 305M AT	27649	356
NIKOR DLP-60-W	07210	266	ONTEC S M5 305M ST	27830	356
NIKOR DLP-75-W	07211	266	ONTEC S W1 302 M COLD AT	25436	356
NOKA O 10A 2G1.0X10M	26210	341	ONTEC S W1 302 M COLD ST	27895	356
NOKA O 10A 2G1.0X15M	26211	341	ONTEC S W1 302M AT	27664	356
NOKA O 10A 2G1.0X20M	26212	341	ONTEC S W1 302M ST	27892	356
NOKA O 10A 2G1.0X30M	26213	341	ORTE LED 18W-NW-O	29160	246
NOKA O 10A 2G1.0X40M	26214	341	ORTE LED 18W-NW-O-SE	29162	246
NOKA O 16A 3G1.5X15M	26205	341	ORTE LED 24W-NW-O	29161	246
NOKA O 16A 3G1.5X20M	26206	341	ORTE LED 24W-NW-O-SE	29163	246
NOKA O 16A 3G1.5X25M	26207	341	OYO 2LED-CW	08120	193
NOKA O 16A 3G1.5X30M	26208	341	OYO 5LED-CW	08121	193
NOKA O 16A 3G1.5X40M	26209	341	OZON DLBS-1AV/27-W	00905	260
NOKA W 10A 3G1.0X10M	26204	340	PAX TL-90LED	22190	207
NOKA W 10A 3G1.0X2M	26200	340	PESSA LED IP44 17W-NW	27533	197
NOKA W 10A 3G1.0X3M	26201	340	PESSA LED IP44 17W-WW	27532	197
NOKA W 10A 3G1.0X5M	26202	340	PESSA LED IP44 9W-NW	27531	197
NOKA W 10A 3G1.0X7M	26203	340	PESSA LED IP44 9W-WW	27530	197
NOMA CTX-DS10C/B-C	02566	190	PICTO ONTEC G TMP1	27480	362
NOME N LED SMD 18W-NW	25493	239	PICTO ONTEC G TMP10	27487	362
NOME N LED SMD 36W-NW	25494	239	PICTO ONTEC G TMP11	27488	362
NOME N LED SMD 48W-NW	25495	239	PICTO ONTEC G TMP12	27489	362
NOTUS 3 EVG 218 NT	19733	228	PICTO ONTEC G TMP13	27490	362
NOTUS 3 EVG 236 NT	19732	228	PICTO ONTEC G TMP14	27491	362
NOTUS 3 EVG 418 NT	19731	228	PICTO ONTEC G TMP15	27492	362
NOTUS 3WS EVG 236 NT	25712	228	PICTO ONTEC G TMP16	27493	362
NOTUS 3WS EVG 418 NT	25711	228	PICTO ONTEC G TMP17	27494	362
NOTUS 4LED 236 NT	22672	227	PICTO ONTEC G TMP18	27495	362
NOTUS 4LED 418 NT	22671	227	PICTO ONTEC G TMP2	27481	362
NOTUS PREMIUM 236 NT	22290	229	PICTO ONTEC G TMP21	27496	362
NOTUS PREMIUM 418 NT	22291	229	PICTO ONTEC G TMP22	27497	362
NOVIA 120 D	25661	304	PICTO ONTEC G TMP23	27498	362
NOVIA 220 D	25660	304	PICTO ONTEC G TMP5	27482	362
NOVIA EL 120 D	25662	304	PICTO ONTEC G TMP50	27501	362
NOVIA EL 220 U/D	25663	304	PICTO ONTEC G TMP51	27502	362
OFIS LED	xxx	24 - 25	PICTO ONTEC G TMP6	27483	362
OFISE S LED	xxx	26 - 27	PICTO ONTEC G TMP67	27499	362
OGIVA D35 GR	27001	110	PICTO ONTEC G TMP68	27500	362
OMERIS N LED 25W-NW-W	23362	266	PICTO ONTEC G TMP7	27484	362
OMERIS N LED 35W-NW-W	23363	266	PICTO ONTEC G TMP8	27485	362
ONSTAR LED-GR	22760	292	PICTO ONTEC G TMP9	27486	362

PICTO ONTEC S TMP1	27503	363	PROFILO K	26548	95
PICTO ONTEC S TMP10	27510	363	PROFILO K 2m	26549	95
PICTO ONTEC S TMP11	27511	363	PROFILO K-W	26550	95
PICTO ONTEC S TMP12	27512	363	PROFILO K-W 2m	26551	95
PICTO ONTEC S TMP13	27513	363	PSR 100	25591	225
PICTO ONTEC S TMP14	27514	363	QULES AC L-C/M	26301	180
PICTO ONTEC S TMP15	27515	363	QULES AC L-W	26300	180
PICTO ONTEC S TMP16	27516	363	QULES AC O-C/M	26304	180
PICTO ONTEC S TMP17	27517	363	QULES AC O-W	26303	180
PICTO ONTEC S TMP18	27518	363	RADAN CT-DSO50	07362	176
PICTO ONTEC S TMP2	27504	363	RADAN CT-DTL50	07361	176
PICTO ONTEC S TMP21	27519	363	RADAN CT-DTO50	07360	176
PICTO ONTEC S TMP22	27520	363	RALF DL-220-W	04820	260
PICTO ONTEC S TMP23	27521	363	RANGO MINI R7S SMD-WW	15099	79
PICTO ONTEC S TMP5	27505	363	RANGO R7S SMD-WW	15098	79
PICTO ONTEC S TMP50	27524	363	RANVI LED EL-10	24430	144
PICTO ONTEC S TMP51	27525	363	RANVI LED EL-40	24433	144
PICTO ONTEC S TMP6	27506	363	RAPID HI LED B22-NW	25403	41
PICTO ONTEC S TMP67	27522	363	RAPID HI LED B22-WW	25402	41
PICTO ONTEC S TMP68	27523	363	RAPID HI LED E27-NW	25401	40
PICTO ONTEC S TMP7	27507	363	RAPID HI LED E27-WW	25400	40
PICTO ONTEC S TMP8	27508	363	RAPID LED E27-NW	22941	40
PICTO ONTEC S TMP9	27509	363	RAPID LED E27-WW	22940	40
PIN W/US	02186	344	RAPID MAXX LED B22-CW	23285	41
PIRES DL-600	08810	252	RAPID MAXX LED B22-WW	23284	41
PIRES DL-600 NS	08811	252	RAPID MAXX LED E27-NW	23283	40
PIRES ECO DL-250	19000	252	RAPID MAXX LED E27-WW	23282	40
PIRES ECO DL-250 NS	19001	252	RAPID PRO LED B22-CW	22953	41
PIRMO LED SMD NW-GR	23710	209	RAPID PRO LED B22-WW	22952	41
PIXA KT-40-B	19301	216	RAPID PRO LED E27-NW	22951	40
PIXA KT-40-W	19300	216	RAPID PRO LED E27-WW	22950	40
PLAFMIN O	25690	130	REGIS 3 EVG 418 PT	19730	230
PLATEN LED CW	23661	203	REGIS 3 OPAL 418 PT	19734	230
PORTOS LED	29070	249	REGIS 3WS EVG 418 PT	25710	230
POWELED P 12V 30W	26810	330	REGIS 3WS OPAL 418 PT	25713	230
POWELED P 12V 60W	26811	330	REGIS 4LED 418 PT	22673	231
PRO GU10 LED 7W-CW	24505	61	REGIS 4LED OPAL 418PT	19736	231
PRO GU10 LED 7W-CW-W	24502	61	REKA LED EL 7W-L-GR	28990	289
PRO GU10 LED 7W-NW	24504	61	REKA LED EL 7W-L-W	28992	289
PRO GU10 LED 7W-NW-W	24501	61	REKA LED EL 7W-O-GR	28991	289
PRO GU10 LED 7WS3-CW	24672	61	REKA LED EL 7W-O-W	28993	289
PRO GU10 LED 7WS3-NW	24671	61	REMI GU10 SMD-CW	14947	57
PRO GU10 LED 7WS3-WW	24670	61	REMI GU10 SMD-WW	14946	57
PRO GU10 LED 7WS6-CW	24675	61	RICO LED 10-18W	07302	330
PRO GU10 LED 7WS6-NW	24674	61	RICO LED 15-24W	07301	330
PRO GU10 LED 7WS6-WW	24673	61	RILA 100	23584	308
PRO GU10 LED 7W-WW	24503	61	RILA 23L-DOWN	23581	308
PRO GU10 LED 7W-WW-W	24500	61	RILA 23L-UP	23580	308
PRODIM GU10-7,5W-CW	24662	62	RILA 30	23583	308
PRODIM GU10-7,5W-NW	24661	62	RILA 81-PEND	23582	308
PRODIM GU10-7,5WS6-CW	24665	62	RITI GU10 B/G	27571	121
PRODIM GU10-7,5WS6-NW	24664	62	RITI GU10 WG	27570	121
PRODIM GU10-7,5WS6-WW	24663	62	RITI REF B	27572	121
PRODIM GU10-7,5W-WW	24660	62	RITI REF SR	27574	121
PROFILO A	19160	85	RITI REF W	27573	121
PROFILO B	19161	86	RODOS CT-DS09-AB	04685	191
PROFILO B 2m	26540	86	RODOS CT-DT09-AB	04688	191
PROFILO C	19162	87	ROGER DL-2LED6	07281	297
PROFILO C 2m	26541	87	ROGER DL-LED12	07280	297
PROFILO D	19163	88	ROLF JQ-O	08821	322
PROFILO D 2m	26542	88	ROLF MINI JQ-L	08822	320
PROFILO E	19164	89	ROLFJQ-L	08820	321
PROFILO E 2m	26543	89	ROLSA LED S-W	24393	113
PROFILO F	26552	90	ROLSO LED IP44 15W-NW	26700	197
PROFILO F 2m	26553	90	ROLSO LED IP44 20W-NW	26701	197
PROFILO G	26558	91	ROPE-NT 150	07870	228,229
PROFILO G 2m	26559	91	ROPE-NT 150 SINGLE	07871	228,229
PROFILO H	26560	92	ROUNDAN LED24W-WW-SR	25844	264
PROFILO H 2m	26561	92	ROUNDAN LED24W-WW-W	25845	264
PROFILO I	26554	93	ROUNDAN V2LED12W-NW-SN	27218	264
PROFILO I 2m	26555	93	ROUNDAN V2LED12W-NW-SR	28930	264
PROFILO I-W	26556	93	ROUNDAN V2LED12W-NW-W	28931	264
PROFILO I-W 2m	26557	93	ROUNDAN V2LED12W-WW-W	28932	264
PROFILO J	26544	94	ROUNDAN V2LED18W-NW-SN	27219	264
PROFILO J 2M	26545	94	ROUNDAN V2LED18W-NW-SR	28933	264
PROFILO J-W	26546	94	ROUNDAN V2LED18W-NW-W	28934	264
PROFILO J-W 2M	26547	94	ROUNDAN V2LED18W-WW-W	28935	264

INDEKS ALFABETYCZNY
ALPHABETICAL INDEX

ROUNDA V2LED24W-NW-SN	27220	264	SIGO R63 LED E27-NW	22738	65
ROUNDA V2LED24W-NW-W	28936	264	SIGO R63 LED E27-WW	22737	65
ROUNDA V2LED6W-NW-SN	27221	264	SILMA LED EL-10	24440	145
ROUNDA V2LED6W-NW-W	28937	264	SILMA LED EL-20	24441	145
ROUNDA V2LED6W-WW-W	28938	264	SILMA LED EL-30	24442	145
RUBINAS 2LED CW	23791	210	SILMA LED EL-40	24443	145
RUBINAS 2LED WW	23790	210	SIMEN DSL B/B/G	29136	151
RUBINAS 3LED CW	23793	210	SIMEN DSL B/G/B	29134	151
RUBINAS 3LED WW	23792	210	SIMEN DSL B/W/B	29131	151
SABIK LED AC-CW	23803	200	SIMEN DSL SR/B/B	29132	151
SABIK LED AC-WW	23802	200	SIMEN DSL W/G/W	29135	151
SABIK LED CW	23110	200	SIMEN DSL W/W/B	29130	151
SABIK LED PIR CW	27375	200	SIMEN DSL W/W/G	29133	151
SABIK LED PIR WW	27374	200	SIMEN DSO B/G	29137	150
SABIK LED WW	23108	200	SIMEN DSO B/W	29138	150
SABIK MINI LED CW	23111	200	SIMEN DSO G/B	29141	150
SABIK MINI LED WW	23109	200	SIMEN DSO G/W	29142	150
SALUT DL-307-S-C/M	00948	203	SIMEN DSO SR/B	29143	150
SANGA DL-100	08050	257	SIMEN DSO W/B	29139	150
SANI IP44 B	29240	115	SIMEN DSO W/G	29140	150
SANI IP44 W	29241	115	SLICK JQ-L-B	08391	321
SANSO LED 15W-NW-SE	26520	247	SLICK JQ-L-W	08390	321
SARI LED B-CH	27980	214	SOALE PV 14	25770	315
SARI LED B-SR	27981	214	SOBI PV 21	25760	314
SARI LED W-SR	27982	214	SOBI PV 50	25761	314
SEALINGS G	26602	91	SOLA LED AC-CW	23805	201
SEIDY CT-DTL250-AL.	18282	158	SOLA LED AC-WW	23804	201
SEIDY CT-DTL250-B	18284	158	SOLA LED CW	23101	201
SEIDY CT-DTL250-W/M	19455	158	SOLA LED WW	23100	201
SEIDY CT-DTL50-AL.	18281	158	SONDA EL-1L	04795	141
SEIDY CT-DTL50-B	18289	158	SONDA EL-2J	04796	141
SEIDY CT-DTL50-W/M	19454	158	SONDA EL-3J	04797	141
SEIDY CT-DTO50-AL.	18280	158	SONDA EL-4L	04798	141
SEIDY CT-DTO50-B	18288	158	SOPER PV	25750	314
SENTO	26820	324	SOPER PV-SE	25751	314
SENZO	26821	324	SOREN L-BL	24414	165
SET105-K	01426	331	SOREN L-GN	24415	165
SET210-N	01433	331	SOREN L-SR CW	24417	165
SET60-K	01425	331	SOREN L-SR WW	24413	165
SEVIA LED 26	23550	301	SOREN O-BL	24411	165
SEVIA LED 26-SE	23551	301	SOREN O-GN	24412	165
SEVIA LED 50	23552	301	SOREN O-SR CW	24416	165
SEVIA LED 50-SO	23553	301	SOREN O-SR WW	24410	165
SEVIA LED 80	23554	301	SORTA 16L-UP	25680	306
SHADE C/D/E/I-FR 2M	26573	87, 88, 89, 93	SORTA 16L-UP-SE	25681	306
SHADE C/D/E/I-FR 2M	26574	87, 88, 89, 93	SORTA 30I-UP	25682	306
SHADE C/D/E/I-W	26575	87, 88, 89, 93	SORTA 50	25683	306
SHADE C/D/E/I-W 2M	26572	87, 88, 89, 93	SORTA 80	25684	306
SHADE C/D/E/I-W 2M	26575	87, 88, 89, 93	SPAG C B/G	27324	156
SHADE A-FR	19170	85	SPAG C WG	27325	156
SHADE B/F-FR	26568	86, 90	SPAG D B/G	27326	156
SHADE B/F-FR 2M	26570	86, 90	SPAG D WG	27327	156
SHADE B/F-W	26569	86, 90	SPAG L B/G	27320	156
SHADE B/F-W 2M	26571	86, 90	SPAG L WG	27321	156
SHADE C/D/E/I-FR	26572	87, 88, 89, 93	SPAG S B/G	27322	156
SHADE C/D/E/I-FR	26573	87, 88, 89, 93	SPAG S WG	27323	156
SHADE CK C/D/E/I-FR	26576	87, 88, 89, 93	SPN BRAVO S/P 12030	28505	225
SHADE CK C/D/E/I-FR2M	26577	87, 88, 89, 93	SPN BRAVO S/P 60-62	28504	225
SHADE CK C/D/E/I-W	26578	87, 88, 89, 93	SPRING I	26601	93
SHADE CK C/D/E/I-W 2M	26579	87, 88, 89, 93	STAN GP	04864	345
SHADE CK G	26580	91	STATO 30W	29220	275
SHADE CK G 2M	26581	91	STATO 50W	29221	275
SHADE J/K-FR	26564	94, 95	STEL LED 350 8-12W	23070	331
SHADE J/K-FR 2m	26566	94, 95	STEL LED 700 6-12W	23071	331
SHADE J/K-W	26565	94, 95	STER TS-MF1	01001	327
SHADE J/K-W 2m	26567	94, 95	STOBI DLP 250-B	26832	124
SHADE-O H-W	26586	92	STOBI DLP 250-W	26833	124
SHADE-O H-W 2m	26587	92	STOBI DLP 350-B	26834	124
SHADE-U H-FR	26582	92	STOBI DLP 350-W	26835	124
SHADE-U H-FR 2m	26583	92	STOBI DLP 450-B	26836	124
SHADE-U H-W	26584	92	STOBI DLP 450-W	26837	124
SHADE-U H-W 2m	26585	92	STOBI DLP 50-B	26830	124
SHARK N EL-60	29060	256	STOBI DLP 50-W	26831	124
SIGO R39 LED E14-NW	22734	65	STONO 20 N	24654	310
SIGO R39 LED E14-WW	22733	65	STONO 30	24651	310
SIGO R50 LED E14-NW	22736	65	STONO 40	24652	310
SIGO R50 LED E14-WW	22735	65	STONO 50	24653	310

STOPPER B	19181	86	TEAR PR-I-WH	22585	269
STOPPER C	19182	84	TEAR PR-PLUG	8168	269
STOPPER D	19183	88	TEAR PR-PLUG-WH	22587	269
STOPPER E	19184	89	TEAR PR-T-LLR-WH	22589	269
STOPPER F	26590	90	TEAR PR-T-RRL-WH	22590	269
STOPPER G	26592	91	TEAR PR-WH	22580	269
STOPPER I	26591	93	TEAR PR-X-WH	22591	269
STOPPER I-W	26603	93	TEAR TR 1M-WH	22592	269
STOPPER J	26588	94	TEAR TR 2M-WH	22593	269
STOPPER J-W	26605	94	TEDI MAXX LED GU10-CW	23413	63
STOPPER K	26589	95	TEDI MAXX LED GU10-NW	23414	63
STOPPER K-W	26606	95	TEDI MAXX LED GU10-WW	23412	63
STOPPER-O H	26594	92	TERRA LED AC-CW	23807	199
STOPPER-U H	26593	92	TERRA LED AC-WW	23806	199
STRAP 2,5/100MM	07962	353	TERRA LED CW	23104	199
STRAP 2,5/120MM	07963	353	TERRA LED PIR CW	27373	199
STRAP 2,5/150MM	07965	353	TERRA LED PIR WW	27372	199
STRAP 3,6/150MM	07966	353	TERRA LED W-CW	26843	199
STRAP 3,6/200MM	07967	353	TERRA LED WW	23102	199
STRAP 3,6/250MM	07968	353	TERRA LED W-WW	26842	199
STRAP 3,6/300MM	07969	353	TERRA MINI LED CW	23105	199
STRAP 4,6/200MM	07970	353	TERRA MINI LED WW	23103	199
STRAP 4,6/250MM	07971	353	TESON AL-DSL50	07373	177
STRAP 4,6/300MM	07972	353	TESON AL-DSO50	07372	177
STREET LED 12000 NW	27332	282	TESON AL-DTL50	07371	177
STREET LED 4000 NW	27330	282	TESON AL-DTO50	07370	177
STREET LED 8000 NW	27331	282	TEZI LED3,5W GU10-CW	27772	59
STREET LED ADTR 15D	27333	282	TEZI LED3,5W GU10-NW	27771	59
SUZI HR-60-B	07151	217	TEZI LED3,5W GU10-WW	27770	59
SUZI HR-60-BL	07152	217	TEZI LED4,5W GU10-CW	27775	59
SUZI HR-60-PK	07153	217	TEZI LED4,5W GU10-NW	27774	59
SUZI HR-60-SR	07150	217	TEZI LED4,5W GU10-WW	27773	59
TIU-11W/K	10672	102	TEZI LED6W GU10-CW	27778	59
TIU-9W/K	10671	102	TEZI LED6W GU10-NW	27777	59
T2U-18W/4P 4000K	08963	102	TEZI LED6W GU10-WW	27776	59
T2U-18W/K	10661	102	TIBERI LED SMD 24W-O	25510	261
T2U-26W/4P 4000K	08961	102	TIBERI LED SMD 36W-O	25511	261
T2U-26W/K	10662	102	TIVA 1030 MDR/ML-DB	70731	129
T5-13W 4000K/65	12716	104	TIVA 1030 MDR/ML-OL	70737	129
T5-14W 4000K/82	12717	104	TIVA 1030 MDR/ML-SN	70730	129
T5-8W 4000K/65	12715	104	TIVA 1030 SDR/ML-DB	70721	129
T8 18W/830 WW	19920	105	TIVA 1030 SDR/ML-OL	70727	129
T8 18W/840 NW	19921	105	TIVA 1030 SDR/ML-SN	70720	129
T8 18W/865 CW	19922	105	TIVA 1030 1/2DR/ML-SN	70740	129
T8 36W/840 NW	19924	105	TIVA 1030 1/2DR/ML-DB	70741	129
T8 36W/865 CW	19925	105	TIVA 1030 1/2DR/ML-OL	70747	129
T8 58W/840 NW	19927	105	TIVA 1130 DDR/ML-DB	70711	129
T8 58W/865 CW	19928	105	TIVA 1130 DDR/ML-OL	70717	129
T8 LED GLASSv2 18W-CW	26060	73	TIVA 1130 DDR/ML-SN	70710	129
T8 LED GLASSv2 18W-NW	22655	73	TOKIA P-G	25522	114
T8 LED GLASSv2 18W-WW	22656	73	TOKIA P-R	25523	114
T8 LED GLASSv2 24W-CW	26061	73	TOKIA P-W/B	25521	114
T8 LED GLASSv2 24W-NW	22657	73	TOLEO DTL250-B	26119	122
T8 LED GLASSv2 9W-CW	22659	73	TOLEO DTL250-W	26120	122
T8 LED GLASSv2 9W-NW	22654	73	TOLEO DTL50-B	26113	122
T8 LED GLASSv2 9W-WW	22658	74	TOLEO DTL50-W	26114	122
T8 LED GLASSv3 18W-CW	26065	74	TOLEO DTO250-W	26117	122
T8 LED GLASSv3 18W-NW	26064	74	TOLEO DTO50-B	26110	122
T8 LED GLASSv3 24W-CW	26067	74	TOLEO DTO50-W	26111	122
T8 LED GLASSv3 24W-NW	26066	74	TOMI LED1,2W GU10-CW	22709	60
T8 LED GLASSv3 9W-CW	26063	74	TOMI LED1,2W GU10-NW	22822	60
T8 LED GLASSv3 9W-NW	26062	74	TOMI LED1,2W GU10-WW	22708	60
T8LED GLASSv3T 18W NW	26068	75	TOMI LED3W GU10-CW	22703	60
TANO G4 SMD-WW	14936	68	TOMI LED3W GU10-NW	22823	60
TAXI SMD L C/M-NW	26461	294	TOMI LED3W GU10-WW	22702	60
TAXI SMD L C/M-WW	26460	294	TOMI LED5W GU10-CW	22701	60
TAXI SMD P C/M-NW	26463	294	TOMI LED5W GU10-NW	22824	60
TAXI SMD P C/M-WW	26462	294	TOMI LED5W GU10-WW	22700	60
TBAO CT-AS02-AL	04701	178	TOMI LED5W MR16-CW	22705	64
TEAR PR-90A-WH	22581	269	TOMI LED5W MR16-WW	22704	64
TEAR PR-90B-WH	22582	269	TOMI LED7W GU10-CW	22820	60
TEAR PR-CORD	19482	269	TOMI LED7W GU10-NW	22825	60
TEAR PR-CORD-WH	22583	269	TOMI LED7W GU10-WW	22821	60
TEAR PR-FLEX	19481	269	TOMI LED7W MR16-CW	22707	64
TEAR PR-FLEX-WH	22584	269	TOMI LED7W MR16-WW	22706	64
TEAR PR-I-B	19480	269	TORIM DLP-250 B-W	28463	126
TEAR PR-I-B-WH	22586	269	TORIM DLP-250 W-B	28462	126

TORIM DLP-50 B-W	28461	126	XLED A60 7W-NW	29602	37
TORIM DLP-50 W-B	28460	126	XLED A60 7W-NW-M	29610	38
TOWE LED 36W-NW	25790	227	XLED A60 7W-STEP CCT	29636	39
TP SLIM LED 40W-NW	27115	238	XLED A60 7W-WW	29601	37
TP SLIM LED 50W-NW	27116	238	XLED A60 7W-WW-M	29609	38
TRAKO LED COB-11	22620	268	XLED A60 8W-CW-M	29614	38
TRAKO LED COB-20	22621	268	XLED A60 8W-NW-M	29613	38
TRETO LED 30W	07800	332	XLED A60 8W-WW	29604	37
TUME LED EL-10	24450	146	XLED A60 8W-WW-M	29612	38
TUME LED EL-20	24451	146	XLED C35E14 2,5W-WW	29617	46
TUME LED EL-30	24452	146	XLED C35E14 4,5W-NW	29619	46
TUME LED EL-40	24453	146	XLED C35E14 4,5W-NW-M	29621	47
TUNA MINI N	08091	257	XLED C35E14 4,5W-WW	29618	46
TUNA S1101-W	04260	257	XLED C35E14 4,5W-WW-M	29620	47
TURK DL-60	07025	256	XLED C35E14 6W-NW-M	29623	47
TURRO LED 30W-NW	18982	295	XLED C35E14 6W-WW-M	29622	47
TWISTER WKK-AOL120B	70956	336	XLED G125 7W-WW	29638	43
TWISTER WKK-AOL120T	70960	336	XLED G45 E14 4,5W-WW	29624	52
TWISTER WKK-AOL100B	70926	336	XLED G45 E14 6W-NW-M	29629	53
TWISTER WKK-AOL100T	70953	336	XLED G45 E14 6W-WW-M	29628	53
TYBIA DL-224L	19010	253	XLED G45 E27 6W-NW-M	29633	53
TYBIA LED 38W-NW	24640	249	XLED G45 E27 6W-WW-M	29632	53
TYBIA LED 38W-NW-SE	24641	249	XLED G45E14 4,5W-NW-M	29627	53
ULKE CT-2113-C	00321	186	XLED G45E14 4,5W-WW-M	29626	53
ULKE CT-2113-C/M	00355	186	XLED G45E27 4,5W-NW-M	29631	53
ULKE CT-2119-C	00313	186	XLED G45E27 4,5W-WW	29625	52
ULKE CT-2119-C/M	00349	186	XLED G45E27 4,5W-WW-M	29630	53
URTICA CT-DTO50-AB	19550	191	XLED ST64 7W-WW	29637	43
VADRA 16L-UP	29010	307	XLEDA60 7W-NW-STEPDIM	29635	39
VADRA 21L-UP SE	29011	307	XLEDA60 7W-WW-STEPDIM	29634	39
VADRA 50	29012	307	ZAFIRAS LED CW	23701	210
VADRA 80	29013	307	ZAFIRAS LED WW	23700	210
VARSO LED 18W-NW-L	26443	244	ZARA HR-40-B	07561	218
VARSO LED 18W-NW-L-SE	26980	244	ZARA HR-40-BL	07562	218
VARSO LED 18W-NW-O	26441	244	ZARA HR-40-OR	07563	218
VARSO LED 18W-NW-O-SE	26981	244	ZARA HR-40-SR	07560	218
VARSO LED 18W-WW-L	26442	244	ZARK KRT/2-1	02180	346
VARSO LED 18W-WW-O	26440	244	ZARK KRW-3	02181	346
VARSO LED 24W-NW-L	26447	244	ZEPO LFD-T02/S-C/M	04386	207
VARSO LED 24W-NW-L-SE	26983	244	ZEPO LFD-T02-C/M	04381	207
VARSO LED 24W-NW-O	26445	244	ZEST. MONT.FLAGI*ONTEC S	27397	357
VARSO LED 24W-NW-O-SE	26984	244	ZEST. MONT.P/T ONTEC R	27399	358
VARSO LED 24W-WW-L	26446	244	ZEST.MONT.P/T ONTEC G	27051	359
VARSO LED 24W-WW-O	26444	244	ZEST.MONT.P/T ONTEC S	27398	357
VERI LED 36W-NW-L	29283	131	ZEW EL-235J-B	22440	287
VERI LED 36W-NW-O	29282	131	ZEW EL-235J-GR	22442	287
VERI LED 36W-WW-L	29281	131	ZEW EL-235U-B	22441	287
VERI LED 36W-WW-O	29280	131	ZEW EL-235U-GR	22443	287
VIDI CTC-5514-AN	02795	173	ZONA FLAT-W	23452	326
VIDI CTC-5514-B	25995	173	ZONA JQ-37-W	00464	319
VIDI CTC-5514-C	02791	173	ZUBI HI LED4WG9-WW	24524	67
VIDI CTC-5514-C/M	02793	173	ZUBI LED 3,5W E14-WW	24525	67
VIDI CTC-5514-W	02790	173	ZUBI LED 3,5W G9-CW	24521	67
VIDI CTC-5515-AN	02785	173	ZUBI LED 3,5W G9-WW	24520	67
VIDI CTC-5515-B	25996	173	ZUBI MAX LED3,5WG9-WW	24522	67
VIDI CTC-5515-C	02781	173			
VIDI CTC-5515-C/M	02783	173			
VIDI CTC-5515-PN	02787	173			
VIDI CTC-5515-W	02780	173			
VIP 136 ST 2	27400	360			
VIP 158 ST 2	27401	360			
VIP PRO 180i AT	27942	360			
VIP PRO 180i AT	27942	360			
W-1 NANO	70514	345			
WIR ZL100	70961	335			
WIR ZL120	70962	335			
XARD DL-40	07195	295			
XLED A60 10W-NW	29606	37			
XLED A60 10W-NW-M	29616	38			
XLED A60 10W-WW	29605	37			
XLED A60 10W-WW-M	29615	38			
XLED A60 4,5W-NW-M	29608	38			
XLED A60 4,5W-WW	29600	37			
XLED A60 4,5W-WW-M	29607	38			
XLED A60 7W-CW	29603	37			
XLED A60 7W-CW-M	29611	38			

00300	ARGUS CT-2114-G	182	02755	CEL CTC-5519-C/M	179
00301	ARGUS CT-2114-C	182	02780	VIDI CTC-5515-W	173
00303	ARGUS CT-2114-W	182	02781	VIDI CTC-5515-C	173
00304	ARGUS CT-2115-G	182	02783	VIDI CTC-5515-C/M	173
00305	ARGUS CT-2115-C	182	02785	VIDI CTC-5515-AN	173
00307	ARGUS CT-2115-W	182	02787	VIDI CTC-5515-PN	173
00309	ARGUS CT-2117-C	182	02790	VIDI CTC-5514-W	173
00311	ARGUS CT-2117-W	184	02791	VIDI CTC-5514-C	173
00313	ULKE CT-2119-C	186	02793	VIDI CTC-5514-C/M	173
00321	ULKE CT-2113-C	186	02795	VIDI CTC-5514-AN	173
00324	ARGUS CT-2114-BR/M	182	02804	BASK CTC-5515-MPC/N	187
00325	ARGUS CT-2114-C/M	182	02806	BASK CTC-5515-SN/N	187
00327	ARGUS CT-2114-AN	182	02814	BASK CTC-5514-MPC/N	187
00328	ARGUS CT-2114-GM	182	02816	BASK CTC-5514-SN/N	187
00330	ARGUS CT-2115-BR/M	182	02820	HORN CTC-3114-SN/G	188
00331	ARGUS CT-2115-C/M	182	02821	HORN CTC-3114-SN/N	188
00333	ARGUS CT-2115-AN	182	02822	HORN CTC-3114-PS/G	188
00334	ARGUS CT-2115-GM	182	02824	HORN CTC-3114-GM/N	188
00336	ARGUS CT-2117-BR/M	182	02830	HORN CTC-3115-SN/G	188
00337	ARGUS CT-2117-C/M	182	02831	HORN CTC-3115-SN/N	188
00340	ARGUS CT-2117-GM	182	02832	HORN CTC-3115-PS/G	188
00349	ULKE CT-2119-C/M	186	02834	HORN CTC-3115-GM/N	188
00355	ULKE CT-2113-C/M	186	04011	AVIA MTH-478/400W-B	276
00402	HLDR-G210	351	04013	AVIA MTH-478/250W-B	276
00405	HLDR-R75	351	04260	TUNA S1101-W	257
00460	ALERJQ-30-W	318	04381	ZEPO LFD-T02-C/M	207
00461	ALERJQ-30-B	318	04386	ZEPO LFD-T02-S-C/M	207
00464	ZONA JQ-37-W	319	04395	MANGO KF-FBG-20A 25M	342
00510	GLORIA TL3011-18W	206	04396	MANGO KF-FBG-23A 40M	342
00511	GLORIA TL3011-30W	206	04397	MANGO KF-FBG-23A 50M	342
00620	ELIOT ZW3-L500P-B	275	04680	DORA LED-J01	292
00810	GAVI CT-2116B-W GAVI	208	04681	LINDA LED-J02	292
00811	GAVI CT-2116B-C	208	04684	LICA LED-J04A	292
00814	GAVI CT-2116B-BR/M	208	04685	RODOS CT-DS09-AB	191
00815	GAVI CT-2116B-C/M GAVI	208	04688	RODOS CT-DT09-AB	191
00821	ELSE CT-2116C-C	192	04693	NAVI CTX-DS10-AB	174
00825	ELSE CT-2116C-C/M	192	04694	NAVI CTX-DS10-C	174
00905	OZON DLBS-1AW/27-W	260	04695	NAVI CTX-DS10-SN	174
00913	DELE AL-204-C/M	185	04701	TBAO CT-AS02-AL	178
00923	DELE AL-205-C/M	185	04703	MARIN CT-S80-C	181
00948	SALUT DL-307-S-C/M	203	04704	MARIN CT-S80-SN	181
01001	STER TS-MF1	327	04710	MARIN CT-S80-AB	181
01016	CYBER TM-6	327	04730	MERA TL-8/4000K	205
01257	IT-1/10-B	364	04731	MERA TL-13/4000K	205
01271	IT-1/20-B	364	04732	MERA TL-21/4000K	205
01272	IT-1/20-Y	364	04733	MERA PP	205
01273	IT-1/20-RE	364	04785	AKRA CT-DS14PS/N	178
01274	IT-1/20-GN	364	04795	SONDA EL-1L	141
01275	IT-1/20-BL	364	04796	SONDA EL-2J	141
01276	IT-1/20-W	364	04797	SONDA EL-3J	141
01277	IT-1/20-Y/GN	364	04798	SONDA EL-4L	141
01283	IT-1/20-MIX	364	04820	RALF DL-220-W	260
01425	SET60-K	331	04841	ADAMO MTH-250/S	277
01426	SET105-K	331	04842	ADAMO MTH-400/S	277
01433	SET210-N	331	04845	ADAMO MTH-250/A	277
01440	ADI 350 1x3W	328	04846	ADAMO MTH-400/A	277
02160	HLDR-E27	348	04862	GRIP GP/S	344
02161	HLDR-E27-F	349	04863	GRIP W/US	344
02162	HLDR-E27-D	349	04864	STAN GP	345
02170	HLDR-E14	347	04870	MORO DL-35	297
02173	HLDR-E14-F	348	04960	MATEO DLP-150-GR	258
02180	ZARK KRT/2-1	346	04961	MATEO DLP-250-GR	258
02181	ZARK KRW-3	346	04962	MATEO DLP-350-GR	258
02186	PIN W/US	344	07015	MARC DL-60	251
02550	NAVI CTX-DT10-W	174	07025	TURK DL-60	256
02551	NAVI CTX-DT10-C	174	07079	BART EL-135	285
02553	NAVI CTX-DT10-C/M	174	07080	BART EL-235	285
02554	NAVI CTX-DT10-AB	174	07081	BART EL-160	285
02566	NOMA CTX-DS10G/B-C	190	07082	BART EL-260	285
02576	DINO CTX-DS02G/B-C	190	07083	BART EL-140	285
02580	LUTO CTX-DS02B-W	175	07085	MOLI EL-10	140
02581	LUTO CTX-DS02B-C	175	07086	MOLI EL-21	140
02583	LUTO CTX-DS02B-C/M	175	07087	MOLI EL-30	140
02584	LUTO CTX-DS02B-AB	175	07088	MOLI EL-41	140
02590	LUTO CTX-DT02B-W	175	07150	SUZI HR-60-SR	217
02591	LUTO CTX-DT02B-C	175	07151	SUZI HR-60-B	217
02593	LUTO CTX-DT02B-C/M	175	07152	SUZI HR-60-BL	217
02594	LUTO CTX-DT02B-AB	175	07153	SUZI HR-60-PK	217

07170	BERG DL-350	296	08666	DANERA CT-DTL35-SC	185
07171	BERG DL-35L	294	08810	PIRES DL-600	252
07180	BS-1 4-22W	334	08811	PIRES DL-600 NS	252
07181	BS-2 4-65W	334	08820	ROLFJQ-L	321
07195	XARD DL-40	295	08821	ROLFJQ-O	322
07210	NIKOR DLP-60-W	266	08822	ROLF MINI JQ-L	320
07211	NIKOR DLP-75-W	266	08850	HLDR-E27/GU10	352
07280	ROGER DL-LED12	297	08851	HLDR-E14/GU10	352
07281	ROGER DL-2LED6	297	08910	MARID JQ-L	319
07301	RICO LED 15-24W	330	08951	LED12 SMD G4-WW	69
07302	RICO LED 10-18W	330	08961	T2U-26W/4P 4000K	102
07360	RADAN CT-DT050	176	08963	T2U-18W/4P 4000K	102
07361	RADAN CT-DTL50	176	08980	JURBA DL-2180	250
07362	RADAN CT-DS050	176	08981	JURBA DL-218L	250
07370	TESON AL-DT050	177	10418	J-1000W 189MM	101
07371	TESON AL-DTL50	177	10419	J-1500W 254MM	101
07372	TESON AL-DS050	177	10432	JC-10W4/EK BASIC	100
07373	TESON AL-DSL50	177	10433	JC-20W4/EK BASIC	100
07560	ZARA HR-40-SR	218	10434	JC-35W4/EK BASIC	100
07561	ZARA HR-40-B	218	10661	T2U-18W/K	102
07562	ZARA HR-40-BL	218	10662	T2U-26W/K	102
07563	ZARA HR-40-OR	218	10671	T1U-9W/K	102
07690	MERGE JQ-L	320	10672	T1U-11W/K	102
07691	MERGE JQ-O	322	10720	JC-5W G4	100
07800	TRETO LED 30W	332	10722	JC-10W G4	100
07860	EURO MTH-250-16PC	281	10724	JC-20W G4	100
07861	EURO MTH-400-16PC	281	10726	JC-35W G4	100
07862	EURO MTH-250-22PC	281	10730	JC-20W GY6.35	100
07863	EURO MTH-400-22PC	281	10732	JC-35W GY6.35	100
07864	EURO MTH-250-21AL	281	10734	JC-50W GY6.35	100
07865	EURO MTH-400-21AL	281	12660	DD-16W/4P 3500K	103
07870	ROPE-NT 150	228,229	12661	DD-21W/4P 3500K	103
07871	ROPE-NT 150 SINGLE	228,229	12662	DD-28W/4P 3500K	103
07900	KIRA DL-75B	251	12663	DD-38W/4P 3500K	103
07962	STRAP 2,5/100MM	353	12715	T5-8W 4000K/65	104
07963	STRAP 2,5/120MM	353	12716	T5-13W 4000K/65	104
07965	STRAP 2,5/150MM	353	12717	T5-14W 4000K/82	104
07966	STRAP 3,6/150MM	353	12755	MHE-250W/4200K	106
07967	STRAP 3,6/200MM	353	12756	MHE-400W/4200K	106
07968	STRAP 3,6/250MM	353	14613	MILE 7041S	254
07969	STRAP 3,6/300MM	353	14936	TANO G4 SMD-WW	68
07970	STRAP 4,6/200MM	353	14946	REMI GU10 SMD-WW	57
07971	STRAP 4,6/250MM	353	14947	REMI GU10 SMD-CW	57
07972	STRAP 4,6/300MM	353	14977	LINUS LINK	206
07980	APO TM-3	346	15098	RANGO R7S SMD-WW	79
08050	SANGA DL-100	257	15099	RANGO MINI R7S SMD-WW	79
08091	TUNA MINI N	257	18010	MAGRA EL-135	286
08103	HAXA-DSO POWER LED-B	193	18011	MAGRA EL-235	286
08120	OYO 2LED-CW	193	18040	DRIFT LED 0-6W	329
08121	OYO 5LED-CW	193	18042	DRIFT LED F 0-18W	211
08168	TEAR PR-PLUG	269	18120	FOGLER DL-2400	250
08220	HLDR-G9	350	18121	FOGLER LED 14W-NW	247
08240	BL-3-4x14H-EVG	333	18131	GRIBLO LED SMD-NW	313
08301	MERA TL-8/2700K	205	18280	SEIDY CT-DT050-AL	158
08302	MERA TL-13/2700K	205	18281	SEIDY CT-DTL50-AL	158
08303	MERA TL-21/2700K	205	18282	SEIDY CT-DTL250-AL	158
08390	SLICK JQ-L-W	321	18284	SEIDY CT-DTL250-B	158
08391	SLICK JQ-L-B	321	18288	SEIDY CT-DT050-B	158
08490	J-80W 78MM STAR	101	18289	SEIDY CT-DTL50-B	158
08491	J-120W 78MM STAR	101	18410	ELLI CTX-DS20	189
08500	J-120W 118MM STAR	101	18420	G9-20W STAR	99
08501	J-160W 118MM STAR	101	18421	G9-33W STAR	99
08502	J-230W 118MM STAR	101	18422	G9-48W STAR	99
08503	J-400W 118MM STAR	101	18423	G9-60W STAR	99
08550	DRIFT LED 3-18W	329	18440	CDH/CL 28W E14	98
08630	GIVRO LED-CW 50M	96	18441	CDH/CL 42W E14	98
08631	GIVRO LED-BL 50M	96	18450	GLH/CL 28W E27	97
08632	GIVRO LED-RE 50M	96	18451	GLH/CL 42W E27	97
08633	GIVRO LED-GN 50M	96	18452	GLH/CL 52W E27	97
08634	GIVRO LED-Y 50M	96	18453	GLH/CL 70W E27	97
08635	GIVRO-X	96	18454	GLH/CL 100W E27	97
08636	GIVRO-90L	96	18510	MORTA CT-DSL50-B	161
08637	GIVRO PR SET	96	18512	MORTA CT-DSL50-SR	161
08638	GIVRO-Z	96	18515	MAH PLUS-118-ABS/PC	236
08639	GIVRO-I	96	18516	MAH PLUS-218-ABS/PS	236
08640	GIVRO-PEND	96	18517	MAH PLUS-218-ABS/PC	236
08641	GIVRO-T	96	18518	MAH PLUS-136-ABS/PS	236
08642	GIVRO LED-WW 50M	96	18519	MAH PLUS-136-ABS/PC	236

18520	MAH PLUS-236-ABS/PS	236	22051	GORDO LED14 SMD-L	296
18521	MAH PLUS-236-ABS/PC	236	22110	MORTA B CT-DSL50-B	163
18523	MAH PLUS-158-ABS/PC	236	22112	MORTA B CT-DSL50-SR	163
18524	MAH PLUS-258-ABS/PS	236	22116	MORTA B CT-DSO50-B	163
18525	MAH PLUS-258-ABS/PC	236	22117	MORTA B CT-DSO50-SR	163
18530	GWEN CT-DTL50-B	172	22140	CONTROLLER LED RGB-RF	84
18531	GWEN CT-DTO50-B	172	22190	PAX TL-90LED	207
18560	EVIT CT-DTL50-AL.	172	22203	LED15 C MR16-WW-B	63
18561	EVIT CT-DTO50-AL.	172	22204	LED15 C MR16-CW-B	63
18600	AGARA LED EL-14L-UP	302	22290	NOTUS PREMIUM 236 NT	229
18601	AGARA LED EL-19I-UP	302	22291	NOTUS PREMIUM 418 NT	229
18602	AGARA LED EL-50	302	22340	FRANCO 15LED SMD KT-W	212
18604	AGARA LED EL-80	302	22341	FRANCO 15LED SMD KT-B	212
18960	CONTROLLER RGB-IR20	84	22371	AZ-10A	326
18982	TURRO LED 30W-NW	295	22422	ESG LED 9W GX53-WW	76
19000	PIRES ECO DL-250	252	22423	ESG LED 9W GX53-NW	76
19001	PIRES ECO DL-250 NS	252	22424	ESG LED 9W GX53-CW	76
19010	TYBIA DL-224L	253	22430	DALLA CT-DTO50-W	157
19030	CONNECTOR 8	81	22431	DALLA CT-DTL50-W	157
19032	CONNECTOR 8-CP	81	22432	DALLA CT-DTO50-B	157
19033	CONNECTOR 8-CPC	81	22433	DALLA CT-DTL50-B	157
19036	CONNECTOR RGB 10-CP	82	22440	ZEW EL-235J-B	287
19037	CONNECTOR RGB 10-CPC	82	22441	ZEW EL-235U-B	287
19038	CONNECTOR RGB 10	82	22442	ZEW EL-235J-GR	287
19061	DABA LED ECO DL-100	243	22443	ZEW EL-235U-GR	287
19062	DABA N LED SMD DL-16W	243	22550	BORD DLP-50-AL	116
19063	DABA N LED SMD DL-22W	243	22551	BORD DLP-50-W	116
19120	DARSA EL-135L-UP	305	22552	BORD DLP-50-B	116
19121	DARSA EL-235T-UP	305	22553	BORD DLP-250-AL	116
19122	DARSA EL-135	305	22554	BORD DLP-250-W	116
19123	DARSA EL-235A	305	22555	BORD DLP-250-B	116
19160	PROFILO A	85	22571	LUNI PRO E27 LED-WW	44
19161	PROFILO B	86	22572	LUNI MAX E27 LED-WW	44
19162	PROFILO C	87	22580	TEAR PR-WH	269
19163	PROFILO D	88	22581	TEAR PR-90A-WH	269
19164	PROFILO E	89	22582	TEAR PR-90B-WH	269
19170	SHADE A-FR	85	22583	TEAR PR-CORD-WH	269
19181	STOPPER B	86	22584	TEAR PR-FLEX-WH	269
19182	STOPPER C	84	22585	TEAR PR-I-WH	269
19183	STOPPER D	88	22586	TEAR PR-I-B-WH	269
19184	STOPPER E	89	22587	TEAR PR-PLUG-WH	269
19190	HANDLE A	85	22589	TEAR PR-T-LLR-WH	269
19300	PIXA KT-40-W	216	22590	TEAR PR-T-RRL-WH	269
19301	PIXA KT-40-B	216	22591	TEAR PR-X-WH	269
19360	MORTA CT-DSL250-B	161	22592	TEAR TR 1M-WH	269
19362	MORTA CT-DSL250-SR	161	22593	TEAR TR 2M-WH	269
19440	MORTA CT-DSO50-B	161	22603	MAH-LED N 20W-NW/PC	234
19442	MORTA CT-DSO50-SR	161	22604	MAH-LED N 40W-NW/PC	234
19454	SEIDY CT-DTL50-W/M	158	22605	MAH-LED N 50W-NW/PC	234
19455	SEIDY CT-DTL250-W/M	158	22620	TRAKO LED COB-11	268
19480	TEAR PR-I-B	269	22621	TRAKO LED COB-20	268
19481	TEAR PR-FLEX	269	22630	DORTO LED COB-20	268
19482	TEAR PR-CORD	269	22631	DORTO LED COB-40	268
19550	URTICA CT-DTO50-AB	191	22654	T8 LED GLASSv2 9W-NW	73
19610	CANTA CTX-DS20	189	22655	T8 LED GLASSv2 18W-NW	73
19640	GLASO EL-10	143	22656	T8 LED GLASSv2 18W-WW	73
19641	GLASO EL-2I	143	22657	T8 LED GLASSv2 24W-NW	73
19642	GLASO EL-3I	143	22658	T8 LED GLASSv2 9W-WW	74
19643	GLASO EL-4I	143	22659	T8 LED GLASSv2 9W-CW	73
19644	GLASO EL-30	143	22660	GIO LED G9-WW	66
19730	REGIS 3 EVG 418 PT	230	22661	GIO LED G9-NW	66
19731	NOTUS 3 EVG 418 NT	228	22662	GIO LED G4 FL-WW	68
19732	NOTUS 3 EVG 236 NT	228	22663	GIO LED G4 FL-NW	68
19733	NOTUS 3 EVG 218 NT	228	22671	NOTUS 4LED 418 NT	227
19734	REGIS 3 OPAL 418 PT	230	22672	NOTUS 4LED 236 NT	227
19736	REGIS 4LED OPAL 418PT	231	22673	REGIS 4LED 418 PT	231
19761	GAVI LED18 SMD-WW-C/M	209	22700	TOMI LED5W GU10-WW	60
19920	T8 18W/830 WW	105	22701	TOMI LED5W GU10-CW	60
19921	T8 18W/840 NW	105	22702	TOMI LED3W GU10-WW	60
19922	T8 18W/865 CW	105	22703	TOMI LED3W GU10-CW	60
19924	T8 36W/840 NW	105	22704	TOMI LED5W MR16-WW	64
19925	T8 36W/865 CW	105	22705	TOMI LED5W MR16-CW	64
19927	T8 58W/840 NW	105	22706	TOMI LED7W MR16-WW	64
19928	T8 58W/865 CW	105	22707	TOMI LED7W MR16-CW	64
19950	DUCE AL-DTL50	119	22708	TOMI LED1,2W GU10-WW	60
19951	DUCE AL-DTO50	119	22709	TOMI LED1,2W GU10-CW	60
22050	GORDO LED14 SMD-O	296			

INDEKS WEDŁUG KODÓW

INDEX BY CODES

22733	SIGO R39 LED E14-WW	65	23423	BILO 6,5W T SMDE14-NW	54
22734	SIGO R39 LED E14-NW	65	23430	DUN 6,5W T SMD E14-WW	48
22735	SIGO R50 LED E14-WW	65	23431	DUN 6,5W T SMD E14-NW	48
22736	SIGO R50 LED E14-NW	65	23450	ALER MINI-W	318
22737	SIGO R63 LED E27-WW	65	23451	MERGE ADJ-O	323
22738	SIGO R63 LED E27-NW	65	23452	ZONA FLAT-W	326
22760	ONSTAR LED-GR	292	23453	MERGE MW-L	323
22770	CROTO LED-GR-L	291	23490	IDO 6,5W T SMD E14-WW	50
22800	MAH PLUS-236/4LED/PC	235	23491	IDO 6,5W T SMD E14-NW	50
22801	MAH PLUS-258/4LED/PC	235	23510	IDAVA 25	312
22820	TOMI LED7W GU10-CW	60	23511	IDAVA 35	312
22821	TOMI LED7W GU10-WW	60	23512	IDAVA 47	312
22822	TOMI LED1,2W GU10-NW	60	23520	IMBER LED NW	192
22823	TOMI LED3W GU10-NW	60	23521	IMBER LED CW	192
22824	TOMI LED5W GU10-NW	60	23530	LUGEA 28L-UP	309
22825	TOMI LED7W GU10-NW	60	23531	LUGEA 31L-UP-SE	309
22940	RAPID LED E27-WW	40	23532	LUGEA 50	309
22941	RAPID LED E27-NW	40	23533	LUGEA 80	309
22950	RAPID PRO LED E27-WW	40	23550	SEVIA LED 26	301
22951	RAPID PRO LED E27-NW	40	23551	SEVIA LED 26-SE	301
22952	RAPID PRO LED B22-WW	41	23552	SEVIA LED 50	301
22953	RAPID PRO LED B22-CW	41	23553	SEVIA LED 50-SO	301
22960	AR-111 LED SL/WW/W	70	23554	SEVIA LED 80	301
22961	AR-111 LED SL/CW/W	70	23572	DB-FF6 12/24VDC	211
22962	AR-111 LED SL/WW/SR	70	23580	RILA 23L-UP	308
22963	AR-111 LED SL/CW/SR	70	23581	RILA 23L-DOWN	308
22970	ES-111 LED SL/WW/W	71	23582	RILA 81-PEND	308
22971	ES-111 LED SL/CW/W	71	23583	RILA 30	308
22972	ES-111 LED SL/WW/SR	71	23584	RILA 100	308
22973	ES-111 LED SL/CW/SR	71	23661	PLATEN LED CW	203
23040	BILO 3W T SMD E14-WW	54	23700	ZAFIRAS LED WW	210
23041	BILO 3W T SMD E27-WW	54	23701	ZAFIRAS LED CW	210
23042	BILO 5W T SMD E14-WW	54	23710	PIRMO LED SMD NW-GR	209
23043	BILO 5W T SMD E27-WW	54	23752	JASMIN 470-W-H	128
23070	STEL LED 350 8-12W	331	23756	JASMIN WE-W	128
23071	STEL LED 700 6-12W	331	23757	JASMIN W-W	128
23100	SOLA LED WW	201	23758	JASMIN W/M-W	128
23101	SOLA LED CW	201	23759	JASMIN 470-GR	128
23102	TERRA LED WW	199	23790	RUBINAS 2LED WW	210
23103	TERRA MINI LED WW	199	23791	RUBINAS 2LED CW	210
23104	TERRA LED CW	199	23792	RUBINAS 3LED WW	210
23105	TERRA MINI LED CW	199	23793	RUBINAS 3LED CW	210
23106	APUS LED WW	198	23800	APUS LED AC-WW	198
23107	APUS LED CW	198	23801	APUS LED AC-CW	198
23108	SABIK LED WW	200	23802	SABIK LED AC-WW	200
23109	SABIK MINI LED WW	200	23803	SABIK LED AC-CW	200
23110	SABIK LED CW	200	23804	SOLA LED AC-WW	201
23111	SABIK MINI LED CW	200	23805	SOLA LED AC-CW	201
23112	LINAR LED WW	202	23806	TERRA LED AC-WW	199
23113	LINAR LED CW	202	23807	TERRA LED AC-CW	199
23114	LIRIA LED WW	201	23860	DRIVE LED 0-15W 12VDC	329
23115	LIRIA LED CW	201	24010	LEDS-P 4W/M IP00-WW	81
23120	JASMIN 270-WE	128	24011	LEDS-P 4W/M IP00-CW	81
23121	JASMIN 370-W/M	128	24012	LEDS-P 4W/M IP54-WW	81
23122	JASMIN 470-WE	128	24013	LEDS-P 4W/M IP54-CW	81
23123	JASMIN 270-W	128	24120	LEDS-P 10W/M IP00 WW	81
23124	JASMIN 370-W	128	24121	LEDS-P 10W/M IP00 CW	81
23125	JASMIN 470-W	128	24122	LEDS-P 10W/M IP54 WW	81
23126	JASMIN 270-W/M	128	24123	LEDS-P 10W/M IP54 CW	81
23127	JASMIN 370-W/M	128	24240	CIRCO LED 12VDC 0-10W	328
23128	JASMIN 470-W/M	128	24241	CIRCO LED 12VDC 0-15W	328
23129	JASMIN 470-A	128	24280	GRAVME O G/HY	111
23282	RAPID MAXX LED E27-WW	40	24281	GRAVME C G/HY	111
23283	RAPID MAXX LED E27-NW	40	24393	ROLSA LED S-W	113
23284	RAPID MAXX LED B22-WW	41	24410	SOREN O-SR WW	165
23285	RAPID MAXX LED B22-CW	41	24411	SOREN O-BL	165
23362	OMERIS N LED 25W-NW-W	266	24412	SOREN O-GN	165
23363	OMERIS N LED 35W-NW-W	266	24413	SOREN L-SR WW	165
23380	DUN 4,5W T SMD E14-WW	48	24414	SOREN L-BL	165
23381	DUN 4,5W T SMD E14-NW	48	24415	SOREN L-GN	165
23382	IDO 4,5W T SMD E14-WW	50	24416	SOREN O-SR CW	165
23383	IDO 4,5W T SMD E14-NW	50	24417	SOREN L-SR CW	165
23412	TEDI MAXX LED GU10-WW	63	24430	RANVI LED EL-10	144
23413	TEDI MAXX LED GU10-CW	63	24433	RANVI LED EL-40	144
23414	TEDI MAXX LED GU10-NW	63	24440	SILMA LED EL-10	145
23420	BILO 6,5W T SMDE27-WW	54	24441	SILMA LED EL-20	145
23421	BILO 6,5W T SMDE27-NW	54	24442	SILMA LED EL-30	145
23422	BILO 6,5W T SMDE14-WW	54	24443	SILMA LED EL-40	145

24450	TUME LED EL-10	146	25582	ANTRA LED50W-NW-SE GR	272
24451	TUME LED EL-20	146	25583	ANTRA LED10W-NW GR	272
24452	TUME LED EL-30	146	25584	ANTRA LED30W-NW GR	272
24453	TUME LED EL-40	146	25585	ANTRA LED50W-NW GR	272
24500	PRO GU10 LED 7W-WW-W	61	25586	ANTRA LED100W-NW GR	272
24501	PRO GU10 LED 7W-NW-W	61	25587	ANTRA LED150W-NW GR	272
24502	PRO GU10 LED 7W-CW-W	61	25588	ANTRA LED20W-NW-SE GR	272
24503	PRO GU10 LED 7W-WW	61	25589	ANTRA LED20W-NW GR	272
24504	PRO GU10 LED 7W-NW	61	25591	PSR 100	225
24505	PRO GU10 LED 7W-CW	61	25660	NOVIA 220 D	304
24510	LEDS-B 4.8W/M IP54-WW	80	25661	NOVIA 120 D	304
24511	LEDS-B 4.8W/M IP54-NW	80	25662	NOVIA EL 120 D	304
24512	LEDS-B 4.8W/M IP54-CW	80	25663	NOVIA EL 220 U/D	304
24513	LEDS-B 4.8W/M IP65-WW	80	25675	MERSA 300-W/M	127
24514	LEDS-B 4.8W/M IP65-NW	80	25678	MERSA 380-W/M	127
24515	LEDS-B 4.8W/M IP65-CW	80	25680	SORTA 16L-UP	306
24516	LEDS-B 4.8W/M IP00-WW	80	25681	SORTA 16L-UP-SE	306
24517	LEDS-B 4.8W/M IP00-NW	80	25682	SORTA 30I-UP	306
24518	LEDS-B 4.8W/M IP00-CW	80	25683	SORTA 50	306
24520	ZUBI LED 3,5W G9-WW	67	25684	SORTA 80	306
24521	ZUBI LED 3,5W G9-CW	67	25690	PLAFMIN O	130
24522	ZUBI MAX LED3,5WG9-WW	67	25700	ANTRA LED200W-NW GR	272
24524	ZUBI HI LED4WG9-WW	67	25701	ANTRA LED10W-NW-SE B	272
24525	ZUBI LED 3,5W E14-WW	67	25702	ANTRA LED20W-NW-SE B	272
24530	LEDS-B 7.2W/M IP00RGB	82	25703	ANTRA LED10W-NW B	272
24531	LEDS-B 7.2W/M IP65RGB	82	25704	ANTRA LED20W-NW B	272
24532	LEDS-B 7.2W/M IP54RGB	82	25705	ANTRA LED30W-NW B	272
24610	MGH/CL 28W E27	98	25706	ANTRA LED30W-NW-SE B	272
24611	MGH/CL 28W E14	98	25707	ANTRA LED50W-NW B	272
24612	MGH/CL 42W E27	98	25708	ANTRA LED50W-NW-SE B	272
24613	MGH/CL 42W E14	98	25710	REGIS 3WS EVG 418 PT	230
24640	TYBIA LED 38W-NW	249	25711	NOTUS 3WS EVG 418 NT	228
24641	TYBIA LED 38W-NW-SE	249	25712	NOTUS 3WS EVG 236 NT	228
24651	STONO 30	310	25713	REGIS 3WS OPAL 418 PT	230
24652	STONO 40	310	25720	AKVEN LED	313
24653	STONO 50	310	25750	SOPER PV	314
24654	STONO 20 N	310	25751	SOPER PV-SE	314
24660	PRODIM GU10-7,5W-WW	62	25760	SOBI PV 21	314
24661	PRODIM GU10-7,5W-NW	62	25761	SOBI PV 50	314
24662	PRODIM GU10-7,5W-CW	62	25770	SOALE PV 14	315
24663	PRODIM GU10-7,5WS6-WW	62	25780	IVIAN LED 4,5W W-WW	261
24664	PRODIM GU10-7,5WS6-NW	62	25781	IVIAN LED 4,5W SN-WW	261
24665	PRODIM GU10-7,5WS6-CW	62	25782	IVIAN LED 4,5W W-NW	261
24670	PRO GU10 LED 7WS3-WW	61	25783	IVIAN LED 4,5W SN-NW	261
24671	PRO GU10 LED 7WS3-NW	61	25790	TOWE LED 36W-NW	227
24672	PRO GU10 LED 7WS3-CW	61	25800	BORD DLP-350-W	116
24673	PRO GU10 LED 7WS6-WW	61	25802	BORD DLP-350-AL	116
24674	PRO GU10 LED 7WS6-NW	61	25824	KATRO N LED 24W-WW-SR	265
24675	PRO GU10 LED 7WS6-CW	61	25844	ROUNDAN LED24W-WW-SR	264
25400	RAPID HI LED E27-WW	40	25845	ROUNDAN LED24W-WW-W	264
25401	RAPID HI LED E27-NW	40	25950	LUNGA 3 3G1.0X1.4M	338
25402	RAPID HI LED B22-WW	41	25951	LUNGA 4 3G1.0X1.4M	338
25403	RAPID HI LED B22-NW	41	25952	LUNGA 5 3G1.0X1.4M	338
25435	ONTEC G E18 301M AT	359	25953	LUNGA 6 3G1.0X1.4M	338
25436	ONTEC S W1 302 M COLD AT	356	25954	LUNGA 53 3G1.0X1.4M	339
25470	GORD DLP 50-W	118	25955	LUNGA S4 3G1.0X1.4M	339
25471	GORD DLP 50-B	118	25956	LUNGA S5 3G1.0X1.4M	339
25472	GORD DLP 50-AL	118	25957	LUNGA S6 3G1.0X1.4M	339
25473	GORD DLP 250-W	118	25990	NAVI CTX-DST10-B	174
25474	GORD DLP 250-B	118	25991	NAVI CTX-DT10-B	174
25493	NOME N LED SMD 18W-NW	239	25995	VIDI CTC-5514-B	173
25494	NOME N LED SMD 36W-NW	239	25996	VIDI CTC-5515-B	173
25495	NOME N LED SMD 48W-NW	239	26033	FULLED GU10-3,3W-WW	58
25510	TIBERI LED SMD 24W-O	261	26034	FULLED GU10-3,3W-NW	58
25511	TIBERI LED SMD 36W-O	261	26035	FULLED GU10-3,3W-CW	58
25521	TOKIA P-W/B	114	26050	NIFO LED 14W E27-WW-W	78
25522	TOKIA P-G	114	26052	NIFO LED 20W E27-WW-W	78
25523	TOKIA P-R	114	26054	NIFO LED 22W E27-WW-W	78
25530	CORDES	113	26060	T8 LED GLASSv2 18W-CW	73
25550	CYDEA F	219	26061	T8 LED GLASSv2 24W-CW	73
25551	CYDEA D	219	26062	T8 LED GLASSv3 9W-NW	74
25552	CYDEA P	114	26063	T8 LED GLASSv3 9W-CW	74
25560	LITEN LED 6W-WW	262	26064	T8 LED GLASSv3 18W-NW	74
25561	LITEN LED 6W-NW	262	26065	T8 LED GLASSv3 18W-CW	74
25562	LITEN LED 8W-WW	262	26066	T8 LED GLASSv3 24W-NW	74
25563	LITEN LED 8W-NW	262	26067	T8 LED GLASSv3 24W-CW	74
25580	ANTRA LED10W-NW-SE GR	272	26068	T8LED GLASSv3T 18W NW	75
25581	ANTRA LED30W-NW-SE GR	272	26070	IMOE DSO50	157

26071	IMOE DSL50	157	26520	SANSO LED 15W-NW-SE	247
26091	DIVISO W 3	343	26540	PROFILO B 2m	86
26110	TOLEO DTO50-B	122	26541	PROFILO C 2m	87
26111	TOLEO DTO50-W	122	26542	PROFILO D 2m	88
26113	TOLEO DTL50-B	122	26543	PROFILO E 2m	89
26114	TOLEO DTL50-W	122	26544	PROFILO J	94
26117	TOLEO DTO250-W	122	26545	PROFILO J 2M	94
26119	TOLEO DTL250-B	122	26546	PROFILO J-W	94
26120	TOLEO DTL250-W	122	26547	PROFILO J-W 2M	94
26200	NOKA W 10A 3G1.0X2M	340	26548	PROFILO K	95
26201	NOKA W 10A 3G1.0X3M	340	26549	PROFILO K 2m	95
26202	NOKA W 10A 3G1.0X5M	340	26550	PROFILO K-W	95
26203	NOKA W 10A 3G1.0X7M	340	26551	PROFILO K-W 2m	95
26204	NOKA W 10A 3G1.0X10M	340	26552	PROFILO F	90
26205	NOKA O 16A 3G1.5X15M	341	26553	PROFILO F 2m	90
26206	NOKA O 16A 3G1.5X20M	341	26554	PROFILO I	93
26207	NOKA O 16A 3G1.5X25M	341	26555	PROFILO I 2m	93
26208	NOKA O 16A 3G1.5X30M	341	26556	PROFILO I-W	93
26209	NOKA O 16A 3G1.5X40M	341	26557	PROFILO I-W 2m	93
26210	NOKA O 10A 2G1.0X10M	341	26558	PROFILO G	91
26211	NOKA O 10A 2G1.0X15M	341	26559	PROFILO G 2m	91
26212	NOKA O 10A 2G1.0X20M	341	26560	PROFILO H	92
26213	NOKA O 10A 2G1.0X30M	341	26561	PROFILO H 2m	92
26214	NOKA O 10A 2G1.0X40M	341	26562	CONNECT-L C	86
26300	QULES AC L-W	180	26563	CONNECT C/D/E/I	87, 88, 89, 93
26301	QULES AC L-C/M	180	26563	CONNECT C/D/E/I	87, 88, 89, 93
26303	QULES AC O-W	180	26563	HANDLE C/D/E/I	87, 88, 89, 93
26304	QULES AC O-C/M	180	26564	SHADE J/K-FR	94, 95
26320	LEDS SET S-DIM IR	83	26565	SHADE J/K-W	94, 95
26321	LEDS SET S-DIM TS	83	26566	SHADE J/K-FR 2m	94, 95
26322	LEDS SET W-SE ACCU	83	26567	SHADE J/K-W 2m	94, 95
26323	LEDS SET W-SE BTRY	83	26568	SHADE B/F-FR	86, 90
26324	LEDS SET B-SE SGL	83	26569	SHADE B/F-W	86, 90
26325	LEDS SET B-SE DBL	83	26570	SHADE B/F-FR 2M	86, 90
26360	ALDO 4LED 1X60	240	26571	SHADE B/F-W 2M	86, 90
26361	ALDO 4LED 1X120	240	26572	SHADE C/D/E/I-W 2M	87, 88, 89, 93
26362	ALDO 4LED 1X150	240	26572	SHADE C/D/E/I-FR	87, 88, 89, 93
26363	ALDO 4LED 2X60	240	26573	SHADE C/D/E/I-FR 2M	87, 88, 89, 93
26364	ALDO 4LED 2X120	240	26573	SHADE C/D/E/I-FR	87, 88, 89, 93
26365	ALDO 4LED 2X150	240	26574	SHADE C/D/E/I-FR 2M	87, 88, 89, 93
26370	ALDO 4LED 1X60R	240	26575	SHADE C/D/E/I-W	87, 88, 89, 93
26371	ALDO 4LED 1X120R	240	26575	SHADE C/D/E/I-W 2M	87, 88, 89, 93
26372	ALDO 4LED 1X150R	240	26576	SHADE CK C/D/E/I-FR	87, 88, 89, 93
26373	ALDO 4LED 2X60R	240	26577	SHADE CK C/D/E/I-FR 2M	87, 88, 89, 93
26374	ALDO 4LED 2X120R	240	26578	SHADE CK C/D/E/I-W	87, 88, 89, 93
26375	ALDO 4LED 2X150R	240	26579	SHADE CK C/D/E/I-W 2M	87, 88, 89, 93
26440	VARSO LED 18W-WW-O	244	26580	SHADE CK G	91
26441	VARSO LED 18W-NW-W	244	26581	SHADE CK G 2M	91
26442	VARSO LED 18W-WW-L	244	26582	SHADE-U H-FR	92
26443	VARSO LED 18W-NW-L	244	26583	SHADE-U H-FR 2m	92
26444	VARSO LED 24W-WW-O	244	26584	SHADE-U H-W	92
26445	VARSO LED 24W-NW-O	244	26585	SHADE-U H-W 2m	92
26446	VARSO LED 24W-WW-L	244	26586	SHADE-O H-W	92
26447	VARSO LED 24W-NW-L	244	26587	SHADE-O H-W 2m	92
26460	TAXI SMD L C/M-WW	294	26588	STOPPER J	94
26461	TAXI SMD L C/M-NW	294	26589	STOPPER K	95
26462	TAXI SMD P C/M-WW	294	26590	STOPPER F	90
26463	TAXI SMD P C/M-NW	294	26591	STOPPER I	93
26480	MERIL DLP-50-W	168	26592	STOPPER G	91
26481	MERIL DLP-250-W	168	26593	STOPPER-U H	92
26490	AWAN LED S-W	215	26594	STOPPER-O H	92
26491	AWAN LED C-W	215	26595	HANDLE J/K	94, 95
26500	LUNGA 3 3G1.0X3M	338	26596	HANDLE B/F	86
26501	LUNGA 3 3G1.0X5M	338	26597	CONNECT C/D/E/I	87, 88, 89, 93
26502	LUNGA 4 3G1.0X3M	338	26597	CONNECT C/D/E/I	87, 88, 89, 93
26503	LUNGA 4 3G1.0X5M	338	26597	HANDLE C/D/E/I	87, 88, 89, 93
26504	LUNGA 5 3G1.0X3M	338	26598	HANDLE G	91
26505	LUNGA 5 3G1.0X5M	338	26599	HANDLE H	92
26506	LUNGA 6 3G1.0X3M	338	26600	HANDLE SIDE H	92
26507	LUNGA 6 3G1.0X5M	338	26601	SPRING I	93
26508	LUNGA S3 3G1.0X3M	339	26602	SEALINGS G	91
26509	LUNGA S3 3G1.0X5M	339	26603	STOPPER I-W	93
26510	LUNGA S4 3G1.0X3M	339	26604	CONNECT-L B	86
26511	LUNGA S4 3G1.0X5M	339	26605	STOPPER J-W	94
26512	LUNGA S5 3G1.0X3M	339	26606	STOPPER K-W	95
26513	LUNGA S5 3G1.0X5M	339	26610	ARTO 1L-SR	259
26514	LUNGA S6 3G1.0X3M	339	26613	ARTO 10-SR	259
26515	LUNGA S6 3G1.0X5M	339	26614	ARTO 2L-SR	259

26616	ARTO 3L-SR	259	26960	MEBA 4LED 2X60 PS	242
26617	ARTO 3L-W	259	26961	MEBA 4LED 2X120 PS	242
26630	G9 GLASS LED2W-WW	66	26962	MEBA 4LED 2X150 PS	242
26631	G9 GLASS LED2W-CW	66	26963	MEBA 4LED 2X60 OP PS	242
26680	ASTEN LED IP44 8W-NW	196	26964	MEBA 4LED 2X120 OP PS	242
26681	ASTEN LED IP44 12W-NW	196	26965	MEBA 4LED 2X150 OP PS	242
26682	ASTEN LED IP44 15W-NW	196	26980	VARSO LED 18W-NW-L-SE	244
26690	DOSAN LED W	213	26981	VARSO LED 18W-NW-O-SE	244
26691	DOSAN LED B	213	26983	VARSO LED 24W-NW-L-SE	244
26700	ROLSO LED IP44 15W-NW	197	26984	VARSO LED 24W-NW-O-SE	244
26701	ROLSO LED IP44 20W-NW	197	27000	ETISSA D20 GR	110
26714	MORTA OCT-SR	164	27001	OGIVA D35 GR	110
26715	MORTA OCT-B	164	27010	KASSI G9 L-W	195
26716	MORTA CT-DT050-SR	162	27011	KASSI G9 O-W	195
26717	MORTA CT-DT050-B	162	27020	ASIL G9 W-B	194
26718	MORTA CT-DTL50-SR	162	27021	ASIL G9 W-GR	194
26719	MORTA CT-DTL50-B	162	27022	ASIL G9 W-W	194
26720	ARET 1XMR16-W	167	27030	ALGO GU10 CL-B	120
26721	ARET 1XMR16-GR	167	27032	ALGO GU10 CL-W	120
26723	ARET 2XMR16-W	167	27033	ALGO GU10 CO-B	120
26724	ARET 2XMR16-GR	167	27035	ALGO GU10 CO-W	120
26725	ARET 2XMR16-C/M	167	27036	ALGO GU10 PL-B	112
26726	ALOR DSL-W	184	27038	ALGO GU10 PL-W	112
26727	ALOR DSL-B	184	27039	ALGO GU10 PO-B	112
26728	ALOR DSL-C	184	27041	ALGO GU10 PO-W	112
26729	ALOR DSL-C/M	184	27050	iTECH M2 302 AT	354
26732	ALOR DTL-B	184	27051	ZEST.MONT.P/T ONTEC G	359
26736	IVRI DTO-W	166	27052	iTECH M5 305 AT	354
26738	APRILA DTO-W	164	27053	iTECH C1 302 MAT 2W	354
26739	APRILA DTL-W	164	27054	ONTEC S M1 301 M AT	356
26740	COLIE DTO-W	170	27056	ONTEC S M2 302 M COLD AT	356
26741	COLIE DTO-G	170	27057	ONTEC S M2 102 M AT	356
26742	COLIE DTO-AL	170	27090	ANTOS LED 10W-NW B	274
26743	COLIE DTO-B	170	27091	ANTOS LED 20W-NW B	274
26744	COLIE DTO-GR	170	27092	ANTOS LED 30W-NW B	274
26745	NESTA DSL-W	171	27093	ANTOS LED 50W-NW B	274
26746	NESTA DSL-B	171	27094	ANTOS LED 10W-NW-SE B	274
26747	NESTA DSL-C	171	27095	ANTOS LED 20W-NW-SE B	274
26748	NESTA DSL-C/M	171	27096	ANTOS LED 30W-NW-SE B	274
26749	NESTA DTL-W	171	27097	ANTOS LED 50W-NW-SE B	274
26750	NESTA DTL-B	171	27110	ANDER LED 60W-NW	237
26751	NESTA DTL-C	171	27115	TP SLIM LED 40W-NW	238
26752	NESTA DTL-C/M	171	27116	TP SLIM LED 50W-NW	238
26753	ALREN DTL-W	169	27150	HB PRO LED 100W-NW	280
26754	ALREN DTL-B	169	27151	HB PRO LED 150W-NW	280
26755	ALREN DTL-C	169	27152	HB REF 15 AL	280
26756	ALREN DTL-C/M	169	27153	HB REF 17 AL	280
26757	ALREN R DTL-B	168	27210	CARSA V2LED 12W-NW-SN	267
26758	ALREN R DTL-W	168	27211	CARSA V2LED 18W-NW-SN	267
26760	DUN HI 8W E14-WW	49	27212	KANTI V2LED 12W-NW-SN	267
26761	DUN HI 8W E14-NW	49	27213	KANTI V2LED 18W-NW-SN	267
26762	BILO HI 8W E14-WW	55	27214	KATRO V2LED 12W-NW-SN	265
26763	BILO HI 8W E14-NW	55	27215	KATRO V2LED 18W-NW-SN	265
26764	BILO HI 8W E27-WW	55	27216	KATRO V2LED 24W-NW-SN	265
26765	BILO HI 8W E27-NW	55	27217	KATRO V2LED 6W-NW-SN	265
26770	AVAR 6060 40W-NW	232	27218	ROUNDA V2LED12W-NW-SN	264
26771	AVAR 6060 40W-CW	232	27219	ROUNDA V2LED18W-NW-SN	264
26773	AVAR 6262 40W-NW	232	27220	ROUNDA V2LED24W-NW-SN	264
26774	AVAR 6262 40W-WW	232	27221	ROUNDA V2LED6W-NW-SN	264
26791	ALOR DSO-B	184	27230	CEMIN DTL-GR	166
26796	ALOR DTO-B	184	27260	LINER LED 18W-NW	239
26810	POWELED P 12V 30W	330	27261	LINER LED 36W-NW	239
26811	POWELED P 12V 60W	330	27262	LINER LED 45W-NW	239
26820	SENTO	324	27270	IQ-LED A60 5,5W-WW	34
26821	SENZO	324	27271	IQ-LED A60 5,5W-NW	34
26830	STOBI DLP 50-B	124	27272	IQ-LED A60 5,5W-CW	34
26831	STOBI DLP 50-W	124	27273	IQ-LED A60 9W-WW	34
26832	STOBI DLP 250-B	124	27274	IQ-LED A60 9W-NW	34
26833	STOBI DLP 250-W	124	27275	IQ-LED A60 9W-CW	34
26834	STOBI DLP 350-B	124	27276	IQ-LED A60 10,5W-WW	34
26835	STOBI DLP 350-W	124	27277	IQ-LED A60 10,5W-NW	34
26836	STOBI DLP 450-B	124	27278	IQ-LED A60 10,5W-CW	34
26837	STOBI DLP 450-W	124	27279	IQ-LED A60 14W-WW	34
26840	APUS LED W-WW	198	27280	IQ-LED A60 14W-NW	34
26841	APUS LED W-CW	198	27281	IQ-LED A60 14W-CW	34
26842	TERRA LED W-WW	199	27282	IQ-LEDDIM A60 5,5W-WW	36
26843	TERRA LED W-CW	199	27283	IQ-LEDDIM A60 5,5W-NW	36
26844	LIRIA LED W-WW	201	27284	IQ-LEDDIM A60 5,5W-CW	36
			27285	IQ-LEDDIM A60 8,5W-WW	36

27286	IQ-LEDDIM A60 8,5W-NW	36	27489	PICTO ONTEC G TMP12	362
27287	IQ-LEDDIM A60 8,5W-CW	36	27490	PICTO ONTEC G TMP13	362
27288	IQ-LEDDIM A6012,5W-WW	36	27491	PICTO ONTEC G TMP14	362
27289	IQ-LEDDIM A6012,5W-NW	36	27492	PICTO ONTEC G TMP15	362
27290	IQ-LEDDIM A6012,5W-CW	36	27493	PICTO ONTEC G TMP16	362
27291	IQ-LEDDIM A60 15W-WW	36	27494	PICTO ONTEC G TMP17	362
27292	IQ-LEDDIM A60 15W-NW	36	27495	PICTO ONTEC G TMP18	362
27293	IQ-LEDDIM A60 15W-CW	36	27496	PICTO ONTEC G TMP21	362
27294	IQ-LED C37E14 5,5W-WW	45	27497	PICTO ONTEC G TMP22	362
27295	IQ-LED C37E14 5,5W-NW	45	27498	PICTO ONTEC G TMP23	362
27296	IQ-LED C37E14 5,5W-CW	45	27499	PICTO ONTEC G TMP67	362
27297	IQ-LED C37E14 7,5W-WW	45	27500	PICTO ONTEC G TMP68	362
27298	IQ-LED C37E14 7,5W-NW	45	27501	PICTO ONTEC G TMP50	362
27299	IQ-LED C37E14 7,5W-CW	45	27502	PICTO ONTEC G TMP51	362
27300	IQ-LED G45E14 5,5W-WW	51	27503	PICTO ONTEC S TMP1	363
27301	IQ-LED G45E14 5,5W-NW	51	27504	PICTO ONTEC S TMP2	363
27302	IQ-LED G45E14 5,5W-CW	51	27505	PICTO ONTEC S TMP5	363
27303	IQ-LED G45E27 5,5W-WW	51	27506	PICTO ONTEC S TMP6	363
27304	IQ-LED G45E27 5,5W-NW	51	27507	PICTO ONTEC S TMP7	363
27305	IQ-LED G45E27 5,5W-CW	51	27508	PICTO ONTEC S TMP8	363
27306	IQ-LED G45E14 7,5W-WW	51	27509	PICTO ONTEC S TMP9	363
27307	IQ-LED G45E14 7,5W-NW	51	27510	PICTO ONTEC S TMP10	363
27308	IQ-LED G45E14 7,5W-CW	51	27511	PICTO ONTEC S TMP11	363
27309	IQ-LED G45E27 7,5W-WW	51	27512	PICTO ONTEC S TMP12	363
27310	IQ-LED G45E27 7,5W-NW	51	27513	PICTO ONTEC S TMP13	363
27311	IQ-LED G45E27 7,5W-CW	51	27514	PICTO ONTEC S TMP14	363
27312	IQ-LED A67 17,5W-WW	35	27515	PICTO ONTEC S TMP15	363
27313	IQ-LED A67 17,5W-NW	35	27516	PICTO ONTEC S TMP16	363
27314	IQ-LED A67 17,5W-CW	35	27517	PICTO ONTEC S TMP17	363
27315	IQ-LED A67 19W-WW	35	27518	PICTO ONTEC S TMP18	363
27316	IQ-LED A67 19W-NW	35	27519	PICTO ONTEC S TMP21	363
27317	IQ-LED A67 19W-CW	35	27520	PICTO ONTEC S TMP22	363
27320	SPAG L B/G	156	27521	PICTO ONTEC S TMP23	363
27321	SPAG L WG	156	27522	PICTO ONTEC S TMP67	363
27322	SPAG S B/G	156	27523	PICTO ONTEC S TMP68	363
27323	SPAG S WG	156	27524	PICTO ONTEC S TMP50	363
27324	SPAG C B/G	156	27525	PICTO ONTEC S TMP51	363
27325	SPAG C WG	156	27530	PESSA LED IP44 9W-WW	197
27326	SPAG D B/G	156	27531	PESSA LED IP44 9W-NW	197
27327	SPAG D WG	156	27532	PESSA LED IP44 17W-WW	197
27330	STREET LED 4000 NW	282	27533	PESSA LED IP44 17W-NW	197
27331	STREET LED 8000 NW	282	27560	ELNER LED 8W-NW-B	288
27332	STREET LED 12000 NW	282	27561	ELNER LED 15W-NW-B	288
27333	STREET LED ADTR 15D	282	27562	ELNER LED 8W-NW-SE-B	288
27360	ISTI LED W	213	27563	ELNER LED 15W-NW-SE-B	288
27361	ISTI LED B	213	27570	RITI GU10 WG	121
27370	APUS LED PIR WW	198	27571	RITI GU10 B/G	121
27371	APUS LED PIR CW	198	27572	RITI REF B	121
27372	TERRA LED PIR WW	199	27573	RITI REF W	121
27373	TERRA LED PIR CW	199	27574	RITI REF SR	121
27374	SABIK LED PIR WW	200	27590	LINUS LED 4W-NW	206
27375	SABIK LED PIR CW	200	27591	LINUS LED 7W-NW	206
27380	iTECH M2 302 M ST W	354	27600	HERON LED B	215
27381	iTECH M5 105 M ST W	354	27601	HERON LED W	215
27382	iTECH C1 302 M ST W	354	27610	ADTR 6060 SR	225
27383	iTECH F2 105 M ST W	354	27611	ADTR 12030 W	225
27390	ONTEC R M2 102 M ST/W	358	27612	ADTR 12030 SR	225
27391	ONTEC R M2 302 M ST/W	358	27613	ADTR 6060 W	225
27392	ONTEC R C1 102 M ST/W	358	27614	ADTR 12030 B	225
27393	ONTEC R C1 302 M ST/W	358	27615	ADTR 6060 B	225
27394	ONTEC G E1B 101 M ST	359	27620	iTECHM2102MCOLDATW	354
27395	ONTEC G E1B 301M ST	359	27622	iTECHM5105MATW	354
27396	ONTEC S M1 301 M ST	356	27623	iTECHM5105MCOLDATW	354
27397	ZEST. MONT.FLAGI*ONTEC S	357	27635	iTECHF1302MATW	354
27398	ZEST. MONT.P/T ONTEC S	357	27638	iTECHF2105MATW	354
27399	ZEST. MONT.P/T ONTEC R	358	27646	ONTEC S M2 102 M AT	356
27400	VIP 136 ST 2	360	27647	ONTEC S M2 302M AT	356
27401	VIP 158 ST 2	360	27648	ONTEC S M5 105M AT	356
27403	BOA IN RM2 302 M AT	355	27649	ONTEC S M5 305M AT	356
27480	PICTO ONTEC G TMP1	362	27652	ONTEC S C1 302M AT	356
27481	PICTO ONTEC G TMP2	362	27664	ONTEC S W1 302M AT	356
27482	PICTO ONTEC G TMP5	362	27672	ONTEC C M2 102M AT	359
27483	PICTO ONTEC G TMP6	362	27673	ONTEC C M2 302M AT	359
27484	PICTO ONTEC G TMP7	362	27684	ONTEC C C1 102M AT	359
27485	PICTO ONTEC G TMP8	362	27730	ONTEC R M2 102M AT	358
27486	PICTO ONTEC G TMP9	362	27731	ONTEC R M2 302M AT	358
27487	PICTO ONTEC G TMP10	362	27732	ONTEC R M5 105M AT	358
27488	PICTO ONTEC G TMP11	362	27738	ONTEC R C1 102 M ST	358

27739	ONTEC R C1 302M AT	358	28029	BRAVO DRIVER 28W	225
27750	ONTEC G E1B 101M AT	359	28250	ARME LED L 5W-WW	262
27770	TEZI LED3,5W GU10-WW	59	28251	ARME LED O 5W-WW	262
27771	TEZI LED3,5W GU10-NW	59	28270	KRALA LED 45W NW	233
27772	TEZI LED3,5W GU10-CW	59	28271	KRALA PLUG-1M	233
27773	TEZI LED4,5W GU10-WW	59	28272	KRALA PR-I	233
27774	TEZI LED4,5W GU10-NW	59	28273	KRALA PP-1M	233
27775	TEZI LED4,5W GU10-CW	59	28274	KRALA PP-0,35M	233
27776	TEZI LED6W GU10-WW	59	28275	KRALA CORD-2M	233
27777	TEZI LED6W GU10-NW	59	28276	KRALA SENSOR	233
27778	TEZI LED6W GU10-CW	59	28460	TORIM DLP-50 W-B	126
27800	ELNIS S W	154	28461	TORIM DLP-50 B-W	126
27801	ELNIS S W/A	154	28462	TORIM DLP-250 W-B	126
27802	ELNIS S A/W	154	28463	TORIM DLP-250 B-W	126
27803	ELNIS S A/C	154	28490	FL MASTER LED 100W-NW	270
27804	ELNIS L W	155	28491	FL MASTER LED 140W-NW	270
27805	ELNIS L W/A	155	28492	FL MASTER LED 220W-NW	270
27806	ELNIS L W/C	155	28500	BRAVO S/P GRIP 60-62	225
27807	ELNIS L A/W	155	28501	BRAVO S/P GRIP 12030	225
27808	ELNIS L A/C	155	28502	CLIPS BRAVO S/P 60-62	225
27809	ELNIS L A	155	28503	CLIPS BRAVO S/P 12030	225
27810	ELNIS L B/G	155	28504	SPN BRAVO S/P 60-62	225
27811	ELNIS L C/W	155	28505	SPN BRAVO S/P 12030	225
27812	ELNIS L C/A	155	28507	BRAVO DALI SET 45W	225
27820	BOA IN RM1 301M ST	355	28508	BRAVO DALI SET 36W	225
27821	BOA IN RM2 302M ST	355	28512	AVAR DALI SET 40W	232
27822	BOA IN RM1 301M AT	355	28520	FLM LED 100W-NW-60D	271
27823	iTECHM2102MCOLDSTW	354	28521	FLM LED100W-NW110/150	271
27825	iTECHM5305MSTW	354	28522	FLM LED 140W-NW-60D	271
27826	iTECHM5105MCOLDSTW	354	28523	FLM LED140W-NW110/150	271
27827	ONTEC S M2 102M ST	356	28524	FLM LED 220W-NW-60D	271
27828	ONTEC S M2 302M ST	356	28525	FLM LED220W-NW110/150	271
27829	ONTEC S M5 105M ST	356	28530	HB MASTER LED 100W	278
27830	ONTEC S M5 305M ST	356	28531	HB MASTER LED 150W	278
27831	ONTEC S M2 302M COLD ST	356	28532	HB MASTER LED 200W	278
27838	ONTEC C M2 102M ST	359	28533	HBM REF ALU100/150W	279
27839	ONTEC C M2 302M ST	359	28534	HBM REF ALU200W	279
27850	ONTEC R M5 105M ST	358	28535	HBM REF PC100/150W	279
27860	BOA IN RC1 302M ST	355	28536	HBM REF PC200W	279
27862	BOA IN C1 302M AT	355	28537	HBM LENS 60D 100/150W	279
27869	iTECHF1302MSTW	354	28538	HBM LENS 90D 100/150W	279
27880	ONTEC S C1 302M ST	356	28539	HBM PC 100D 100/150W	279
27892	ONTEC S W1 302M ST	356	28540	HBM LENS 60D 200W	279
27895	ONTEC S W1 302 M COLD ST	356	28541	HBM LENS 90D 200W	279
27902	ONTEC C C1 102M ST	359	28542	HBM PC 100D 200W	279
27920	ONTEC S M1 301M ST IP44	356	28543	HBM BRACKET 100/150W	279
27942	VIP PRO 180i AT	360	28544	HBM BRACKET 200W	279
27942	VIP PRO 180i AT	360	28545	HBM GRID 100/150W	279
27944	ONTEC S MIU 301N MST IP44	356	28546	HBM GRID 200W	279
27960	MORTA AR/ES O-SR	160	28550	BRAVO PU36W12030NW W	222-223
27961	MORTA AR/ES O-B	160	28551	BRAVO PU28W3060NW W	222-223
27963	MORTA AR/ES L-B	160	28700	BONIS DSO-W	153
27980	SARI LED B-CH	214	28701	BONIS DSO-C	153
27981	SARI LED B-SR	214	28702	BONIS DSL-W	153
27982	SARI LED W-SR	214	28703	BONIS DSL-C	153
28000	BRAVO P 36W6060NW W	222-223	28720	BIGGE LED 42W-WW-O	248
28001	BRAVO P 36W6060NW SR	222-223	28721	BIGGE LED 42W-NW-O	248
28002	BRAVO PU36W6060NW W	222-223	28722	BIGGE LED 42W-WW-L	248
28003	BRAVO PU36W6060NW SR	222-223	28723	BIGGE LED 42W-NW-L	248
28006	BRAVO P 36W6060CW W	222-223	28760	ENALI EL-10 W	138
28008	BRAVO P 45W6060NW W	222-223	28761	ENALI EL-10 B	138
28009	BRAVO P 45W6060NW SR	222-223	28762	ENALI EL-21 W	138
28010	BRAVO S 40W6060NW W	224-225	28763	ENALI EL-21 B	138
28011	BRAVO S 40W6060NW SR	224-225	28764	ENALI EL-30 W	138
28012	BRAVO SU40W6060NW W	224-225	28765	ENALI EL-30 B	138
28013	BRAVO SU40W6060NW SR	224-225	28766	ENALI EL-31 W	138
28016	BRAVO S 40W6060CW W	224-225	28767	ENALI EL-31 B	138
28018	BRAVO S 50W6060NW W	224-225	28768	ENALI EL-41 W	138
28019	BRAVO S 50W6060NW SR	224-225	28769	ENALI EL-41 B	138
28020	BRAVO P 36W12030NW W	222-223	28770	LARITO EL-1L-W	136
28021	BRAVO P 36W12030NW SR	222-223	28771	LARITO EL-1L-B	136
28022	BRAVO S 40W12030NW W	224-225	28772	LARITO EL-21-W	136
28023	BRAVO S 40W12030NW SR	224-225	28773	LARITO EL-21-B	136
28024	BRAVO PU36W6262NW W	222-223	28774	LARITO EL-31-W	136
28025	BRAVO DRIVER 36W	225	28775	LARITO EL-31-B	136
28026	BRAVO DRIVER 40W	225	28776	LARITO EL-4L-W	136
28027	BRAVO DRIVER 45W	225	28777	LARITO EL-4L-B	136
28028	BRAVO DRIVER 50W	225	28778	LARITO EL-4L-W	136

28779	LARITO EL-4I-B	136	29128	LAURIN EL-40 W	134
28780	MINI GORD DLP-50-W	148	29129	LAURIN EL-40 B	134
28781	MINI GORD DLP-50-B	148	29130	SIMEN DSL W/W/B	151
28782	MINI BORD DLP-50-W	148	29131	SIMEN DSL B/W/B	151
28783	MINI BORD DLP-50-B	148	29132	SIMEN DSL SR/B/B	151
28790	FOLLO LED W	212	29133	SIMEN DSL W/W/G	151
28791	FOLLO LED B	212	29134	SIMEN DSL B/G/B	151
28800	BART DL-125	286	29135	SIMEN DSL W/G/W	151
28801	BART DL-160	286	29136	SIMEN DSL B/B/G	151
28830	DIMG0 105	332	29137	SIMEN DSO B/G	150
28930	ROUNDA V2LED12W-NW-SR	264	29138	SIMEN DSO B/W	150
28931	ROUNDA V2LED12W-NW-W	264	29139	SIMEN DSO W/B	150
28932	ROUNDA V2LED12W-WW-W	264	29140	SIMEN DSO W/G	150
28933	ROUNDA V2LED18W-NW-SR	264	29141	SIMEN DSO G/B	150
28934	ROUNDA V2LED18W-NW-W	264	29142	SIMEN DSO G/W	150
28935	ROUNDA V2LED18W-WW-W	264	29143	SIMEN DSO SR/B	150
28936	ROUNDA V2LED24W-NW-W	264	29160	ORTE LED 18W-NW-O	246
28937	ROUNDA V2LED6W-NW-W	264	29161	ORTE LED 24W-NW-O	246
28938	ROUNDA V2LED6W-WW-W	264	29162	ORTE LED 18W-NW-O-SE	246
28939	KATRO V2LED 12W-NW-SR	265	29163	ORTE LED 24W-NW-O-SE	246
28940	KATRO V2LED 12W-NW-W	265	29170	INVO OP EL-53-L-GR	299
28941	KATRO V2LED 12W-WW-W	265	29171	INVO OP 47-L-GR	299
28942	KATRO V2LED 18W-NW-SR	265	29172	INVO OP 77-L-GR	299
28943	KATRO V2LED 18W-NW-W	265	29173	INVO OP 107-L-GR	299
28944	KATRO V2LED 18W-WW-W	265	29174	INVO TR EL-53-O-GR	300
28945	KATRO V2LED 24W-NW-W	265	29175	INVO TR 47-O-GR	300
28946	KATRO V2LED 6W-NW-W	265	29176	INVO TR 77-O-GR	300
28947	KATRO V2LED 6W-WW-W	265	29177	INVO TR 107-O-GR	300
28948	CARSA V2LED 12W-NW-W	267	29200	JASMIN 370-A	128
28949	CARSA V2LED 18W-NW-W	267	29201	JASMIN A-W	128
28950	KANTI V2LED 12W-NW-W	267	29210	MERA LED 5W NW	204
28951	KANTI V2LED 18W-NW-W	267	29211	MERA LED 10W NW	204
28990	REKA LED EL 7W-L-GR	289	29212	MERA LED 15W NW	204
28991	REKA LED EL 7W-O-GR	289	29213	MERA LED 20W NW	204
28992	REKA LED EL 7W-L-W	289	29214	MERA LED PP	204
28993	REKA LED EL 7W-O-W	289	29220	STATO 30W	275
29000	GORI EL 135 D	303	29221	STATO 50W	275
29001	GORI EL 235 D	303	29230	LUNIO DTO-W	152
29002	GORI 50	303	29235	GOVIK DSO-W	149
29003	GORI 80	303	29236	GOVIK DSO-B	149
29010	VADRA 16L-UP	307	29240	SANI IP44 B	115
29011	VADRA 21L-UP SE	307	29241	SANI IP44 W	115
29012	VADRA 50	307	29250	FORRO LED EL 8W-GR	290
29013	VADRA 80	307	29251	FORRO LED EL 8W-W	290
29020	EBRI LED 17W E27-WW	42	29260	BISO LED EL 8W-GR	290
29021	EBRI LED 17W E27-NW	42	29261	BISO LED EL 8W-W	290
29022	EBRI LED 21W E27-WW	42	29270	GARTO LED EL 8W-GR	291
29023	EBRI LED 21W E27-NW	42	29271	GARTO LED EL 8W-W	291
29030	IMINES DSL-W	152	29280	VERI LED 36W-WW-O	131
29031	IMINES DSO-W	153	29281	VERI LED 36W-WW-L	131
29040	LUNATI GU10 W	115	29282	VERI LED 36W-NW-O	131
29041	LUNATI GU10 B	115	29283	VERI LED 36W-NW-L	131
29050	MERSA 300-B/M	127	29300	MODv2 12W LED-WW	77
29051	MERSA 380-B/M	127	29301	MODv2 12W LED-NW	77
29060	SHARK N EL-60	256	29302	MODv2 19W LED-WW	77
29070	PORTOS LED	249	29303	MODv2 19W LED-NW	77
29100	EVELI EL-10	142	29310	CHIRO GU10 DTO-W	147
29101	EVELI EL-21	142	29311	CHIRO GU10 DTO-B	147
29102	EVELI EL-30	142	29312	CHIRO GU10 DTL-W	147
29103	EVELI EL-41	142	29313	CHIRO GU10 DTL-B	147
29110	MILENO EL-10 B-AG	132	29580	AREL LED DO 6W-NW	263
29111	MILENO EL-10 ASR-AN	132	29581	AREL LED DO 6W-WW	263
29112	MILENO EL-30 B-AG	132	29582	AREL LED DL 6W-NW	263
29113	MILENO EL-30 ASR-AN	132	29583	AREL LED DL 6W-WW	263
29114	MILENO EL-21 B-AG	132	29584	AREL LED DO 10W-NW	263
29115	MILENO EL-21 ASR-AN	132	29585	AREL LED DO 10W-WW	263
29116	MILENO EL-31 B-AG	132	29586	AREL LED DL 10W-NW	263
29117	MILENO EL-31 ASR-AN	132	29587	AREL LED DL 10W-WW	263
29118	MILENO EL-41 B-AG	132	29588	AREL LED DO 14W-NW	263
29119	MILENO EL-41 ASR-AN	132	29589	AREL LED DO 14W-WW	263
29120	LAURIN EL-10 W	134	29590	AREL LED DL 14W-NW	263
29121	LAURIN EL-10 B	134	29591	AREL LED DL 14W-WW	263
29122	LAURIN EL-21 W	134	29592	AREL LED DO 20W-NW	263
29123	LAURIN EL-21 B	134	29593	AREL LED DO 20W-WW	263
29124	LAURIN EL-31 W	134	29594	AREL LED DL 20W-NW	263
29125	LAURIN EL-31 B	134	29595	AREL LED DL 20W-WW	263
29126	LAURIN EL-30 W	134	29600	XLED A60 4,5W-WW	37
29127	LAURIN EL-30 B	134	29601	XLED A60 7W-WW	37

29602	XLED A60 7W-NW	37	70756	ARDEA 1130 DG/ML-SR	130
29603	XLED A60 7W-CW	37	70761	ARDEA 1030 SG/ML-SR	130
29604	XLED A60 8W-WW	37	70782	ARDEA 1130 D/ML-BI	130
29605	XLED A60 10W-WW	37	70784	ARDEA 1030 S/ML-BI	130
29606	XLED A60 10W-NW	37	70786	ARDEA 1030 M/ML-BI	130
29607	XLED A60 4,5W-WW-M	38	70788	ARDEA 1030 1/2/ML-BI	130
29608	XLED A60 4,5W-NW-M	38	70910	CYKLON WKK-EOL100	337
29609	XLED A60 7W-WW-M	38	70911	CYKLON WKK-EOL100B	337
29610	XLED A60 7W-NW-M	38	70915	CYKLON WKK-EOL120	337
29611	XLED A60 7W-CW-M	38	70916	CYKLON WKK-EOL120B	337
29612	XLED A60 8W-WW-M	38	70920	CYKLON WKK-EOL150	337
29613	XLED A60 8W-NW-M	38	70921	CYKLON WKK-EOL150B	337
29614	XLED A60 8W-CW-M	38	70926	TWISTER WKK-AOL100B	336
29615	XLED A60 10W-WW-M	38	70936	CYKLON WKK-EOL100HT	337
29616	XLED A60 10W-NW-M	38	70937	CYKLON WKK-EOL100P	337
29617	XLED C35E14 2,5W-WW	46	70938	CYKLON WKK-EOL100T	337
29618	XLED C35E14 4,5W-WW	46	70941	CYKLON WKK-EOL120HT	337
29619	XLED C35E14 4,5W-NW	46	70942	CYKLON WKK-EOL120P	337
29620	XLED C35E14 4,5W-WW-M	47	70943	CYKLON WKK-EOL120T	337
29621	XLED C35E14 4,5W-NW-M	47	70947	CYKLON WKK-EOL150P	337
29622	XLED C35E14 6W-WW-M	47	70948	CYKLON WKK-EOL150T	337
29623	XLED C35E14 6W-NW-M	47	70953	TWISTER WKK-AOL100T	336
29624	XLED G45 E14 4,5W-WW	52	70956	TWISTER WKK-AOL120B	336
29625	XLED G45E27 4,5W-WW	52	70960	TWISTER WKK-AOL120T	336
29626	XLED G45E14 4,5W-WW-M	53	70961	WIR ZL100	335
29627	XLED G45E14 4,5W-NW-M	53	70962	WIR ZL120	335
29628	XLED G45 E14 6W-WW-M	53	72109	HLDR-GX5.3	350
29629	XLED G45 E14 6W-NW-M	53	72369	BR-GZ10	347
29630	XLED G45E27 4,5W-WW-M	53	xxx	ALIN LED	18 - 19
29631	XLED G45E27 4,5W-NW-M	53	xxx	ALIN LED LINE	20 - 21
29632	XLED G45 E27 6W-WW-M	53	xxx	ALIN 4LED	22 - 23
29633	XLED G45 E27 6W-NW-M	53	xxx	OFIS LED	24 - 25
29634	XLEDA60 7W-WW-STEPDIM	39	xxx	OFISE S LED	26 - 27
29635	XLEDA60 7W-NW-STEPDIM	39	xxx	FUTURIO LED	28 - 29
29636	XLED A60 7W-STEP CCT	39			
29637	XLED ST64 7W-WW	43			
29638	XLED G125 7W-WW	43			
29803	IQ-LED GU10 5W-WW	56			
29804	IQ-LED GU10 5W-NW	56			
29805	IQ-LED GU10 5W-CW	56			
29806	IQ-LED GU10 7W S3-WW	56			
29807	IQ-LED GU10 7W S3-NW	56			
29808	IQ-LED GU10 7W S3-CW	56			
29809	IQ-LED GU10 7W-WW	56			
29810	IQ-LED GU10 7W-NW	56			
29811	IQ-LED GU10 7W-CW	56			
29812	IQ-LEDIM GU10 6,5W-WW	57			
29813	IQ-LEDIM GU10 6,5W-NW	57			
29814	IQ-LEDIM GU10 6,5W-CW	57			
29820	BLINGO LED36W 6060 NW	226			
29821	BLINGO LED48W 6060 NW	226			
29832	LART EL-160-GR	284			
29833	LART EL-260-GR	284			
70480	BL-118H-EVG	333			
70481	BL-136H-EVG	333			
70482	BL-158H-EVG	333			
70483	BL-218H-EVG	333			
70484	BL-236H-EVG	333			
70485	BL-258H-EVG	333			
70486	BL-418H-EVG	333			
70513	GP-2	343			
70514	W-1 NANO	345			
70522	MILO 7040T	254			
70523	MILO 7040T/P	254			
70524	HERMI 7063NB	255			
70525	INES 7061N	253			
70710	TIVA 1130 DDR/ML-SN	129			
70711	TIVA 1130 DDR/ML-DB	129			
70717	TIVA 1130 DDR/ML-OL	129			
70720	TIVA 1030 SDR/ML-SN	129			
70721	TIVA 1030 SDR/ML-DB	129			
70727	TIVA 1030 SDR/ML-OL	129			
70730	TIVA 1030 MDR/ML-SN	129			
70731	TIVA 1030 MDR/ML-DB	129			
70737	TIVA 1030 MDR/ML-OL	129			
70740	TIVA 1030 1/2DR/ML-SN	129			
70741	TIVA 1030 1/2DR/ML-DB	129			
70747	TIVA 1030 1/2DR/ML-OL	129			

KANLUX SA

ul. Objazdowa 1 - 3, 41 - 922 Radzionków
POLSKA
tel. +48 32/388 74 00
fax +48 32/388 74 99
e-mail: kanlux@kanlux.pl

KANLUX UK DISTRIBUTION

mob. 077 2524 9456
mob. 074 6679 1303
e-mail: kanlux.uk@kanlux.com

KANLUX S.R.O.

Sadová 618, 738 01 Frýdek-Místek
ČESKÁ REPUBLIKA
tel. +420 558 402 511, 603 504 218
fax +420 558 694 250
e-mail: kanlux.cz@kanlux.cz

KANLUX S.R.O.

M.R. Štefánika 379/19, 911 01 Trenčín
SLOVENSKÁ REPUBLIKA
tel. +421 327 446 385-6
fax +421 327 446 387
e-mail: kanlux.sk@kanlux.sk

KANLUX KFT.

9026 Győr, Bácsai út 153/b
HUNGARY
tel. +36 96 525-467
fax +36 96 319-420
e-mail: info@kanlux.hu

ТОВ КАНЛЮКС

08130, Київська область, Києво-Святошинський район,
с.Петропавлівська Борщагівка, вул. Соборна,
будинок 1-Б, офіс 617 УКРАЇНА
тел. +38 (044) 585 33 19
факс +38 (44) 585 33 18
e-mail: kanlux_ua@kanlux.com

ООО КАНЛЮКС-ЭЛЕКТРОМОНТАЖ

142100, Московская область, г. Подольск,
ул. Комсомольская, д.1,
РОССИЙСКАЯ ФЕДЕРАЦИЯ
тел. +7 495 984 82 60
e-mail: russia@kanlux.com

KANLUX EOOD

Warehouse area Gopet Logistics, 1532 Kazichene, Sofia
BULGARIA
tel. +359 2 421 96 24
fax +359 2 421 96 23
e-mail: kanlux.bg@kanlux.com

KANLUX GMBH

Flugplatz 21, 44319 Dortmund
DEUTSCHLAND
Tel. +49 231 56557255
Fax +49 231 56557256
e-mail: kanlux.gmbh@kanlux.com

KANLUX LIGHTING SRL

Intrarea Binelui 1A, Sector 4, 042159 Bucuresti
ROMANIA
tel. +40 371 474 133
e-mail: comenzi@kanlux.com

KANLUX FRANCE SAS

224bis, rue Marcadet, 75018 Paris
FRANCE
tel +33 (0)6 51 64 28 79
e-mail: kanlux.fr@kanlux.com

KANLUX ITALY DISTRIBUTION

mob. + 39 (0) 340 950 26 05
e-mail: kanlux.it@kanlux.com

więcej niż
more than light
światło.

NOTA PRAWNA

Niniejsza publikacja została przygotowana przez Kanlux SA. Poprzez ciągłe udoskonalanie swojej oferty i dostosowanie jej do wymogów rynkowych i prawnych Kanlux SA zastrzega sobie prawo do wprowadzenia zmian w asortymencie.

Prezentowana publikacja nie jest ofertą w rozumieniu Kodeksu Cywilnego. Rzeczywiste produkty mogą odbiegać od poglądowych zdjęć i rysunków zamieszczonych w publikacji. Wszystkie dane zawarte w publikacji obowiązują w dniu oddania jej do druku tj. 19 sierpnia 2019.

Kanlux SA nie ponosi odpowiedzialności za brak dostępności produktów zamieszczonych w niniejszej publikacji. Kanlux SA nie ponosi także odpowiedzialności za jakiegokolwiek bezpośrednie, pośrednie, przypadkowe lub jakiegokolwiek inne szkody (w tym również, ale nie wyłącznie, utracone zyski, utracone przychody lub podobne straty ekonomiczne) powstałe w wyniku korzystania z informacji zawartych w niniejszej publikacji.

Kanlux SA zastrzega sobie prawo do błędów i zmian w druku.

LAW NOTICE

This publication has been prepared by Kanlux SA. Through the continuous improvement of its offer and adaptation of it to market and legal requirements, Kanlux SA reserves the right to make changes in its product mix.

This publication is not an offer within the meaning of the Civil Code. Actual products may differ from illustrative photos and drawings included in the publication. All of the data contained in the publication is in force on the date of printing i.e. 19th of August 2019.

Kanlux SA shall not be liable for the non-availability of products listed in this publication. Kanlux SA also shall not be liable for any direct, indirect, accidental or any other damages (including, but not limited to, lost profits, lost revenues or similar economic losses) arising out of the use of information contained in this publication.

Kanlux SA reserves the right for errors and changes in print.



kanlux.com